

## EXECUTIVE SUMMARY

**AMUSE** ion source (**Figure 1**) eliminates fundamental limitations of conventional electrospray ionization (ESI), thereby providing scientists involved in biomedicine, clinical chemistry, and drug discovery with a unique mass spectrometry (MS) ion source for high-throughput, ultra-sensitive, and fast multiplexed analysis of biomolecules.<sup>[1, 2]</sup> This technology allows operation at low DC ionization voltages with a wide range of solvents, as well as has potential to accommodate large variation in the sample flow rate from 10's of nL/min to 100's of  $\mu\text{L}/\text{min}$  and to minimize the required sample size. Thus, it is inherently suitable for parallel, high throughput operation as well as multiplexing in the array format. The first demonstration of AMUSE operation is dated back to 2004,<sup>[3]</sup> and successful ionization of tuning compounds was reported by our group in 2005.<sup>[4]</sup>

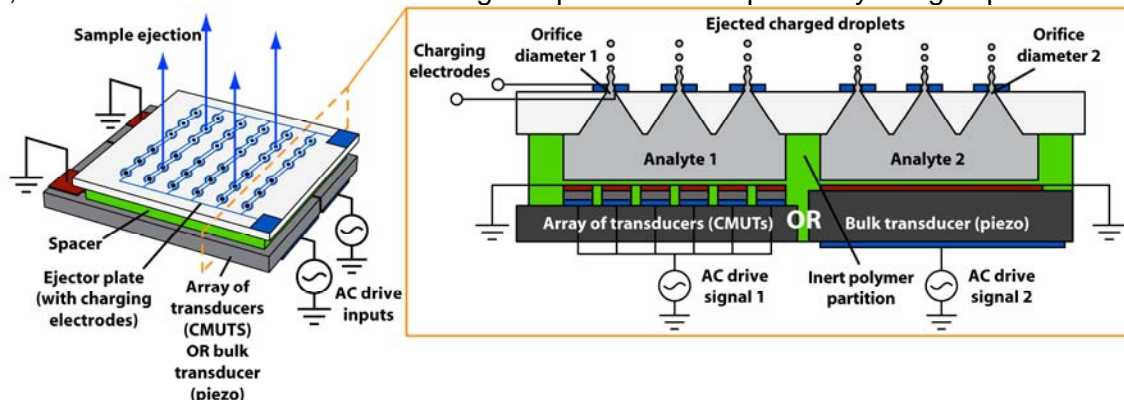

**Figure 1: Schematic of the baseline embodiment of a multiplexed AMUSE source with dual reservoirs.**<sup>[4, 5]</sup>

The AMUSE source has intrinsic properties which naturally lend themselves to overcome the solvent compatibility issue of LC-MS analysis. This is primarily due to the mechanical means of producing the ejected droplets in AMUSE (**Figure 2**), which is decoupled from the charge separation process performed using localized electric fields acting on the ejected droplets containing analyte molecules. Thus, the droplet production and charging processes are no longer the slaves of an applied voltage and solution composition, as it is in conventional ESI, and can be tuned for optimal analytical sensitivity and sample throughput.

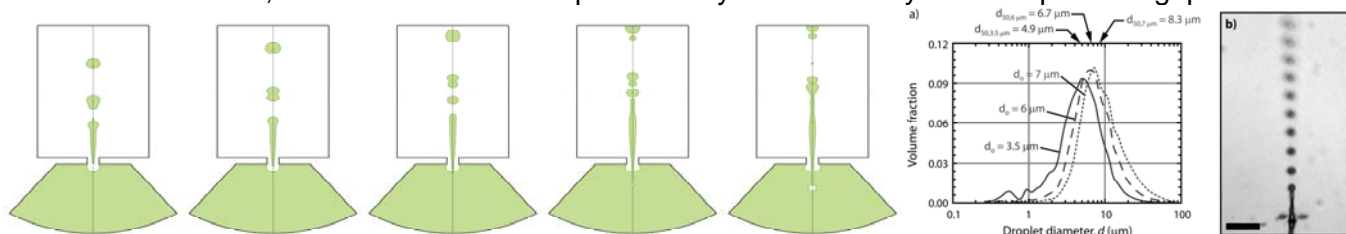

**Figure 2: LEFT PANEL: CFD predictions of droplet generation by AMUSE ion source at 1 MHz operating frequency and 500 kPa acoustic pressure at the nozzle apex for an entire range of solvent composition relevant to reverse-phase LC (from left to right: acetonitrile in water composition varies 0%, 20%, 40%, 60%, 80%, accounting for viscosity and surface tension variation). We have demonstrated the validity of such simulations experimentally.<sup>[6, 7]</sup> RIGHT PANEL: (a) Laser diffraction measurements of droplet size distributions for water ejection from AMUSE nozzle orifices ranging from 3.5-7  $\mu\text{m}$  at a driving frequency of  $\sim 1$  MHz. (b) High-resolution stroboscopic visualization of droplet ejection from a single 4.5  $\mu\text{m}$  nozzle at 0.785 MHz (scale bar is 20  $\mu\text{m}$ ).**

In addition to the advantages discussed above with regards to the decoupling of droplet formation and ejection from the charge separation process leading to solvent independence, the AMUSE ion source is a versatile device that can be configured to couple to different size LC separation columns to handle a broad spectrum of required sample flow rates, sample capacities and post column volume required for biological applications. **Table 1** and **Figure 3** summarize and cross-correlate relevant information that maps the LC parametric space into design space of the AMUSE ion source.

**Table 1: Summary of liquid chromatography options and operating ranges**

	<b>Column i.d.</b>	<b>Flow Rate</b>	<b>Sample Capacity</b>	<b>Post Column Volume</b>
<b>HPLC</b>	4.6 mm	100-3000 $\mu\text{L}/\text{min}$	1-200 $\mu\text{g}$	100-3000 $\mu\text{L}$
<b>MicroLC</b>	1.0 mm	10-100 $\mu\text{L}/\text{min}$	0.05-10 $\mu\text{g}$	1-100 $\mu\text{L}$
<b>CapillaryLC</b>	300 $\mu\text{m}$	1-10 $\mu\text{L}/\text{min}$	1-1000 ng	100-1000 nL
<b>NanoLC</b>	25-100 $\mu\text{m}$	50-1000 nL/min	0.02-0.05 ng	$\sim 100$ nL

The two main curves in **Figure 3** represent continuous flow (points marked “online” #1 through #4) and direct infusion (points marked “offline” #5 through #10) mode of operation. The online sample loading configurations are suitable for continuous sample injection from a multi-nozzle AMUSE array, whereas in the offline loading mode a subset of nozzles is filled and is useful for ionization of ultra-small sample volumes via direct infusion analysis. The areas below each curve are included in the device’s operational range to show that the device allows for complete control over flow rate and ejection volume. Flow rates can be decreased by control of the operation duty cycle (percentage of a time period that the RF signal is applied to the transducer driving droplet generation by the AMUSE ion source). This allows the online configurations to accommodate the full range of LC flow rates. The offline configurations do not require matching LC flow rates. In these devices, the sample fractions would be initially separated, collected and then loaded into the desired number of wells of the microarray for ejection and ionization. When operation is required for ultra-small volume samples and a wide range of flow rates (see area surrounding point #10 in **Figure 3**), operation of the AMUSE source with only a single active nozzle may be required. To achieve such a precise control of ejection from an individual nozzle in an array without a cross-talk among the nozzles in the array, an alternate actuation technology called **C**apacitive **M**icromachined **U**ltrasonic **T**ransducers (**CMUT**) would be required to replace the bulk piezoelectric transducer used in the baseline AMUSE device.

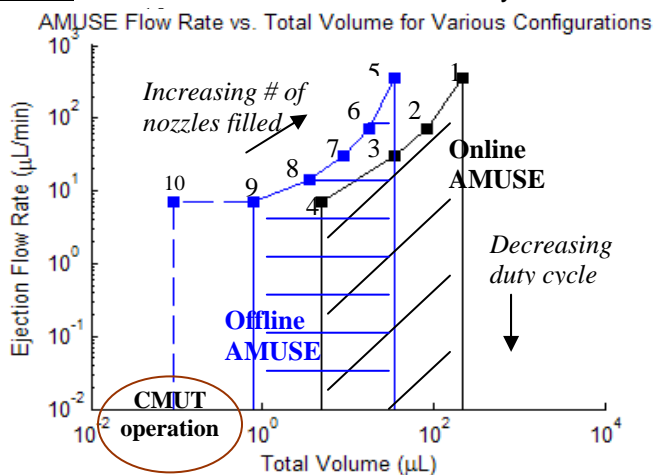

Figure 3: Flow rate and sample volume mapping of the AMUSE ion source design into the LC operation.

replace the bulk piezoelectric transducer used in the

## RESULTS AND ACCOMPLISHMENTS

With support from the NIH R21 RR021474-01A1 (08/2006-06/2010) we have demonstrated the viability and unique advantages of the AMUSE ion source, including the following major results:

- A multiplexed AMUSE ion source as shown in **Figure 4** was developed for use as a soft-ionization ion source for multiplexed mass spectrometry (MS). Such a multiplexed ion source aims to reduce MS analysis time for multiple analyte streams, as well as allows for the synchronized ejection of the sample(s) and an internal standard for quantitative results and mass calibration. This establishes the foundation for multiplexed operation of the AMUSE ion source in conjunction with mass spectrometric detection. Multiplexing was achieved at the device level by division of the fluid reservoir and separating the active electrodes of the piezoelectric transducer for isolated application of ultrasonic wave energy to each domain. The transducer was mechanically shaped to further reduce the acoustic cross-talk between the domains.<sup>[5]</sup>

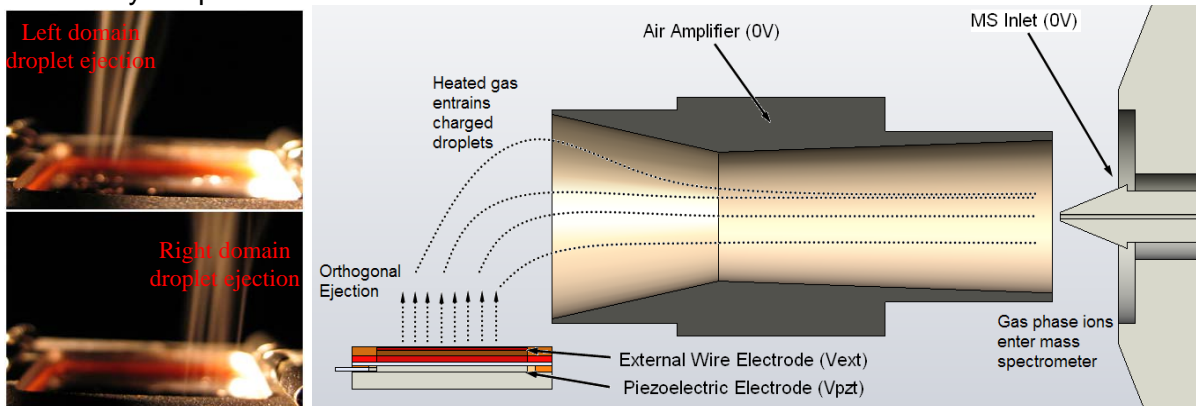
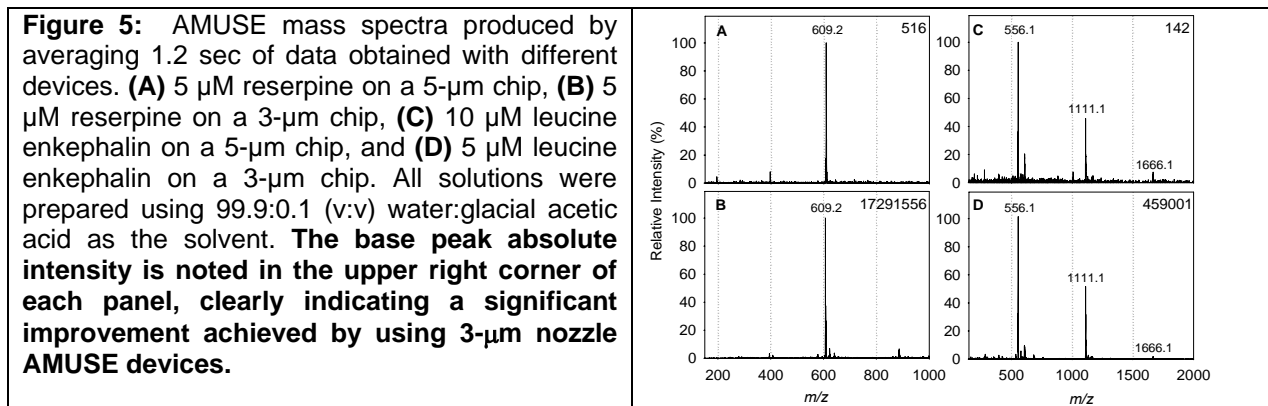
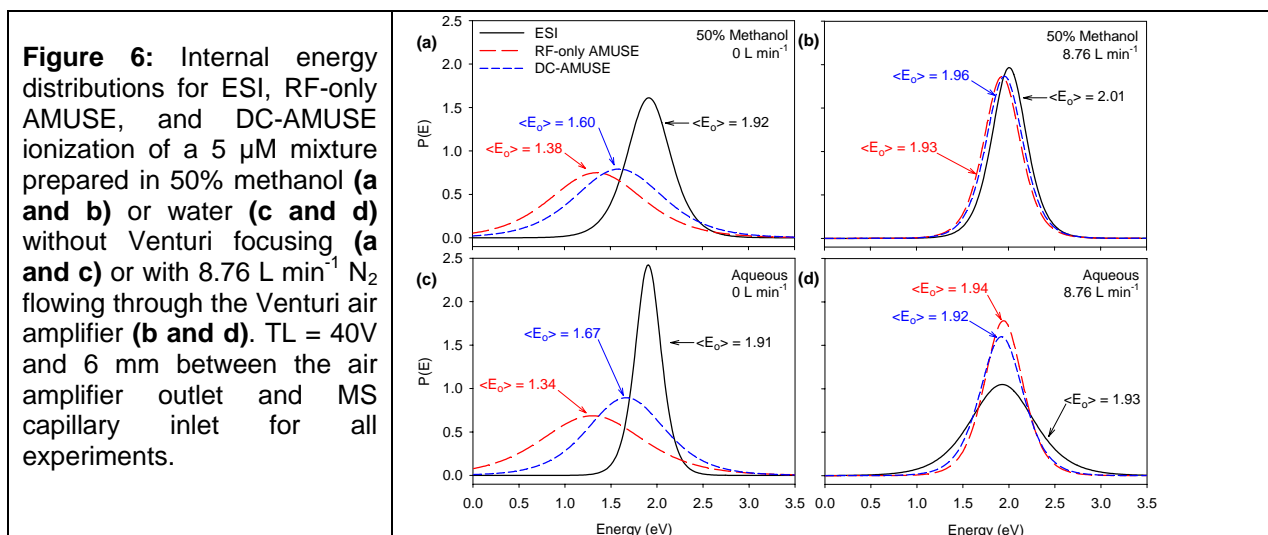

Figure 4: LEFT: Images of isolated ejection from individual domains of the multiplexed AMUSE ion source. RIGHT: Integration and droplet desolvation/ion transmission scheme for AMUSE-MS experiments.

- Successful ionization of peptides (e.g. BNP-32, angiotensin I, bradykinin, melittin), drug molecules (e.g., chlorpromazine) and proteins (e.g., cytochrome c) has been demonstrated at picomole to femtomole levels per nozzle using the AMUSE ion source coupled to linear and quadrupolar ion trap (LiT and QiT), time-of-flight (microTOF) and Fourier transform ion cyclotron resonance (FT-ICR) mass spectrometers. The AMUSE ion source has been shown to enable analyte ionization from acidified water solutions with widely varying concentrations of organic solvents, including purely aqueous solutions, while operated with vanishingly small charging DC voltages as shown in **Figure 5**. Modifications to the fabrication protocol to generate 3- $\mu\text{m}$  arrays led to an increase in sensitivity by  $\geq 3$  orders of magnitude and up to a 10-fold increase in SNR.<sup>[8]</sup>



- Ultra-soft ionization by AMUSE has been demonstrated, as compared to traditional ESI, via a comprehensive study on the internal energy deposited during AMUSE ionization using the thermometer ion method. The results show that AMUSE ionization without Venturi assistance is inherently softer than ESI with a mean internal energy that is 39% lower, as shown in **Figure 6**. Examination of the energy landscapes demonstrated that ions with a mean internal energy lower than 1.5 eV could be obtained using 46% of the conditions tested during RF-only AMUSE compared to 42% of those tested during ESI. Finally, it was shown that at all Venturi air amplifier gas flow rates tested, the *average signal-to-noise ratio of the intact methyl-substituted thermometer ion by AMUSE was five times higher than by ESI at 230 °C and eight times higher at 300°C due to the background noise suppression by AMUSE.*<sup>[9]</sup>



- One of the main benefits of the AMUSE ion source is its ability to separate droplet formation from charge separation. While AMUSE enables droplet generation without utilizing the electric field, and thus independent on the electrochemical properties (composition) of the solvent, efficient charge separation within an ejected droplet is essential to achieve an improved charging of the analyte and thus higher sensitivity of the MS analysis. This is achieved by optimizing the placement of external (charge) electrodes (**Figure 1**), relative to the droplet ejection aperture, to realize an electric field promoting electrophoretic pumping of positively-charged (for the positive mode of operation) analyte molecules within the droplets upon their ejection. Our analysis of charge distribution in an ejected droplet is in agreement with experimental observations that localized application of an external electric field induces charge separation, thereby placing an increasingly large net charge on a droplet upon ejection. In particular, we have shown that using an external “charging” electrode placed in the vicinity of the nozzle apex a favorable electric field can be established to draw charged biomolecules toward the fluid-air interface resulting in an efficient mean for charge separation within an ejected droplet.<sup>[10, 11]</sup> Further, the data show that the use of charge separation electrodes not only increases the signal intensity by establishing a favorable electric field at the point of droplet ejection, but it also improves MS signal stability. An in-depth theoretical and experimental study of electrohydrodynamics and electrochemistry of droplet ejection in the presence of a DC/AC electric fields has been conducted to yield the *optimal conditions of droplet charging in AMUSE as a function of an interplay between independently controlled mechanical and electrical fields* (**Figure 7**).<sup>[12-14]</sup>
- Incorporation of the air amplifier (Venturi) device between the AMUSE and MS provided a *10-fold gain in both the signal and signal-to-noise ratio obtained using a 5- $\mu\text{m}$  nozzle array as well as a 4-fold reduction in the relative standard deviation of the corresponding area in the total ion trace indicating an overall increase in sensitivity and stability* as a result of the improved droplet desolvation and focusing efficiency of this setup.<sup>[8]</sup> The physical mechanisms responsible for improved signal stability and sensitivity of MS analysis when an ion source (including AMUSE) is coupled with MS via an air amplifier ion transmission interface have been identified,<sup>[15]</sup> resulting in an improved design of the ion transmission line. Based on fundamental principles of electrohydrodynamics, heat and mass transfer, we developed a novel device and method (DRILL: DRY Ion Localization & Locomotion, **Figure 8**) which utilize the converging vortex flow in combination with electrodes for confining (localizing), de-solvating and guiding charged droplets/particles from the ion source to the MS inlet, including local ion themolization.<sup>[16, 17]</sup>

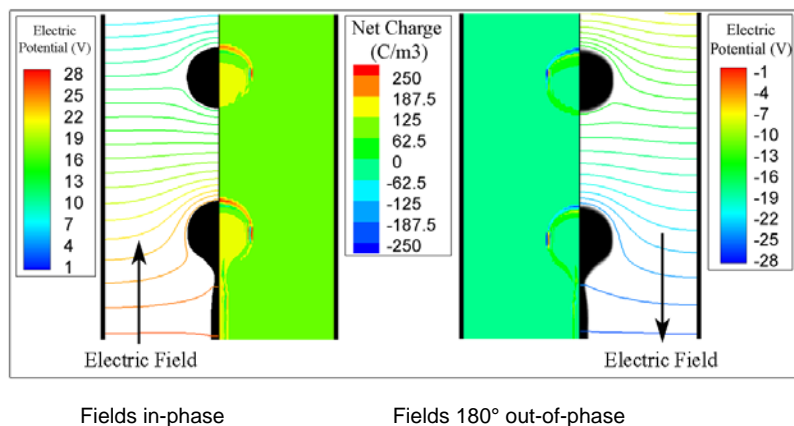

**Figure 7:** Controlled positive/negative droplet charging by in-phase & out-of-phase electrical (charging) & mechanical (ejection) fields.

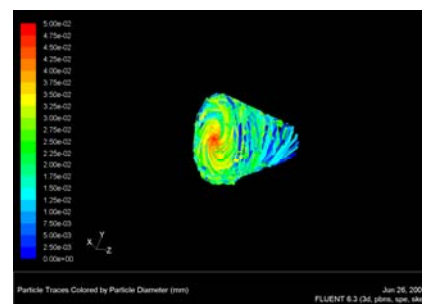
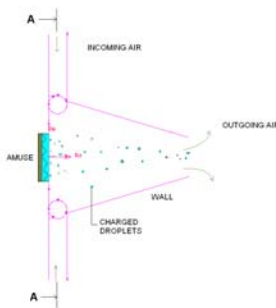
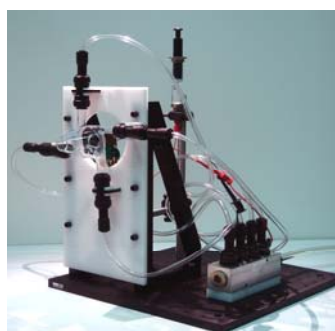

**Figure 8:** LEFT: Schematic of DRILL-AMUSE interface; RIGHT: Desolvation curves for different droplet sizes.

## References:

1. Fedorov, A.G. and F.L. Degertekin, *Electrospray Systems and Methods*. US Patent No. 7,208,727, 2007.
2. Fedorov, A.G. and F.L. Degertekin, *Electrospray Systems and Methods*. US Patent No. 7,557,342, 2009.
3. Meacham, J., C. Ejimofor, S. Kumar, F. Degertekin, and A. Fedorov, *Micromachined ultrasonic droplet generator based on a liquid horn structure*. Review of Scientific Instruments, 2004. **75**: p. 1347.
4. Aderogba, S., J. Meacham, F. Degertekin, A. Fedorov, and F. Fernandez, *Nanoelectrospray ion generation for high-throughput mass spectrometry using a micromachined ultrasonic ejector array*. Applied Physics Letters, 2005. **86**: p. 203110.
5. Forbes, T., F. Degertekin, and A. Fedorov, *Multiplexed operation of a micromachined ultrasonic droplet ejector array*. Review of Scientific Instruments, 2007. **78**: p. 104101.
6. Meacham, J., M. Varady, F. Degertekin, and A. Fedorov, *Droplet formation and ejection from a micromachined ultrasonic droplet generator: Visualization and scaling*. Physics of Fluids, 2005. **17**: p. 100605.
7. Meacham, J., M. Varady, D. Esposito, F. Degertekin, and A. Fedorov, *A micromachined ultrasonic atomizer for liquid fuels*. Atomization and Sprays, 2008. **18**(2): p. 163-190.
8. Hampton, C.Y., T.P. Forbes, M.J. Varady, J.M. Meacham, A.G. Fedorov, F.L. Degertekin, and F.M. Fernandez, *Analytical Performance of a Venturi-Assisted Array of Micromachined Ultrasonic ElectroSprays Coupled to Ion Trap Mass Spectrometry for the Analysis of Peptides and Proteins*. Analytical Chemistry, 2007. **79**(21): p. 8154-8161.
9. Hampton, C., C. Silvestri, T. Forbes, M. Varady, J. Meacham, A. Fedorov, F. Degertekin, and F. Fernández, *Comparison of the Internal Energy Deposition of Venturi-Assisted Electrospray Ionization and a Venturi-Assisted Array of Micromachined UltraSonic ElectroSprays (AMUSE)*. Journal of the American Society for Mass Spectrometry, 2008. **19**(9): p. 1320-1329.
10. Forbes, T.P., R.B. Dixon, D.C. Muddiman, F.L. Degertekin, and A.G. Fedorov, *Characterization of Charge Separation in the Array of Micromachined UltraSonic ElectroSpray (AMUSE) Ion Source for Mass Spectrometry*. Journal of the American Society for Mass Spectrometry, 2009. **20**(9): p. 1684-1687.
11. Forbes, T.P., F.L. Degertekin, and A.G. Fedorov, *Electrohydrodynamics of Charge Separation in Droplet-Based Ion Sources with Time-Varying Electrical and Mechanical Actuation*. Journal of the American Society for Mass Spectrometry. **21**(4): p. 501-510.
12. Forbes, T.P., Degertekin, F.L., and Fedorov, A.G., *Regime transition in electromechanically-charged spray*. Journal of the American Society for Mass Spectrometry, in review, 2010.
13. Forbes, T.P., Degertekin, F.L., and Fedorov, A.G., *Droplet charging regimes in ultrasonic atomization of a liquid electrolyte in an external electric field*. Physics of Fluids, in review, 2010.
14. Forbes, T.P., Degertekin, F.L., and Fedorov, A.G., *Electrochemical ionization and analyte charging in Array of Micromachined UltraSonic ElectroSpray(AMUSE) ion source*. Journal of Electroanalytical Chemistry, 2010, **645** (2): p. 167-173.
15. Dixon, R.B., D.C. Muddiman, A.M. Hawkrige, and A.G. Fedorov, *Probing the Mechanism of an Air Amplifier using a LTQ-FT-ICR-MS and Fluorescence Spectroscopy*. J. Am. Soc. Mass Spectrom., 2007. **18**(11): p. 1909-1913.
16. Fedorov, A.G., Jane, A., **DRILL: Atmospheric Pressure Confining/Focusing Vortex Flow Structure and Method of Generating/Transmitting Dry Ions from Ion Source to Mass Analyzer**, in ASMS Annual Meeting. 2008, American Society of Mass Spectrometry: Denver, Colorado.
17. Fedorov, A.G., *Confining/Focusing Vortex Flow Transmission Structure, Mass Spectrometry Systems, and Methods of Transmitting Particles, Droplets, and Ions*. US Patent No. 7,595,487, 2009.