

**MONTE CARLO SIMULATIONS FOR HOMELAND SECURITY USING
ANTHROPOMORPHIC PHANTOMS**

A Thesis
Presented to
The Academic Faculty

by

Kimberly A Burns

In Partial Fulfillment
of the Requirements for the Degree
Master of Science in the
George W. Woodruff School of Mechanical Engineering

Georgia Institute of Technology
January 2008

**MONTE CARLO SIMULATIONS FOR HOMELAND SECURITY USING
ANTHROPOMORPHIC PHANTOMS**

Approved by:

Dr. Nolan E. Hertel, Advisor
Nuclear and Radiological Engineering
Georgia Institute of Technology

Dr. Chris Wang
Nuclear and Radiological Engineering
Georgia Institute of Technology

Dr. Keith Eckerman
Oak Ridge National Laboratory

Dr. Armin J. Ansari
Centers for Disease Control and Prevention

Date Approved:

ACKNOWLEDGEMENTS

First I would like to thank my family. They have always believed in me and supported me. If it was not for their love and support, I would not be where I am today.

I would like to acknowledge Dr. Hertel for being a great advisor and an inspiration. He has shown me that I am capable of achieving much more than I could have ever imagined. Thank you, Dr. Hertel, for challenging me and believing in me. Additionally, I would like to thank my reading committee, Dr. Chris Wang, Dr. Keith Eckerman and Dr. Armin J. Ansari, for their time and input. I would like to acknowledge the Centers for Disease Control and Prevention Radiation Studies Branch for funding this work. I would also like to thank Ryan Manger for all of his help with DCAL and troubleshooting the phantoms and Michael Bellamy for his help with Mathematica. Finally I would like to thank Eric Burgett and Dwayne Blaylock for helping me solve some difficult MCNP problems and keeping the Linux boxes running. I could not have accomplished all of this without everyone's help. Thank you.

TABLE OF CONTENTS

ACKNOWLEDGEMENTS	iii
LIST OF TABLES	vi
LIST OF FIGURES	xvi
SUMMARY	xviii
CHAPTER 1 INTRODUCTION	1
CHAPTER 2 METHOD	3
2.1 Monte Carlo Simulations	4
2.2 Dose Calculations	9
CHAPTER 3 ANTHROPOMORPHIC PHANTOMS	14
3.1 Reference Male and Reference Female Phantoms	14
3.2 Adipose Male, Adipose Female and Postmenopausal Adipose Female Phantoms	16
CHAPTER 4 DOSE TO HEALTHCARE PROVIDERS	19
4.1 Externally Contaminated Patients	19
4.2 Internally Contaminated Patients	26
4.3 Comparison of Dose to Healthcare Provider Due to Internally and Externally Contaminated Patients	38
CHAPTER 5 DOSE TO PATIENTS	41
5.1 Reference Male	41
5.2 Reference Female	43
5.3 Adipose Male	44
5.4 Adipose Female	45
5.5 Postmenopausal Adipose Female	47

5.6 Comparison of Dose for Different Body Types	48
5.7 Beta Dose to Patient	51
CHAPTER 6 CONCLUSIONS	53
APPENDIX A Composition of Surgical Table	54
APPENDIX B Mass of Each Compartment of Phantoms	55
APPENDIX C Reference Male Input File	56
APPENDIX D Reference Female Input File	64
APPENDIX E Adipose Male Input File	72
APPENDIX F Adipose Female Input File	80
APPENDIX G Postmenopausal Adipose Female Input File	88
APPENDIX H Effective Dose Contribution by Organ to Patient	97
APPENDIX I Effective Dose to Healthcare Provider Due to Externally Contaminated Patient	100
APPENDIX J Effective Dose to Healthcare Provider Due to Internally Contaminated Patient	113
APPENDIX K Absorbed Dose to Patient	126
APPENDIX L Absorbed Dose to Organs for Healthcare Provider Due to Externally Contaminated Patient	129
APPENDIX M Absorbed Dose to Organs for Healthcare Provider Due to Internally Contaminated Patient	142
REFERENCES	155

LIST OF TABLES

Table I	Average Dose for Isotopes of 1 ALI Internal Contamination ($\mu\text{Sv/hr}$)	xix
Table II	Average Effective Dose for Isotopes for a 37 GBq/m^2 External Contamination (mSv/hr)	xx
Table III	Dose to Patient from 37 GBq/m^2 External Contamination (mSv/hr)	xx
Table 1.1	Dose to Patient from Bridges' Study (mSv/hr) [1]	2
Table 1.2	Dose to Healthcare Provider from Bridges' Study (mSv/hr) [1]	2
Table 1.3	Dose to Healthcare Provider from Smith et al. [8]	2
Table 2.1	Radioisotope Energies and Intensities	3
Table 2.2	Surface Area of Skin for Anthropomorphic Phantoms	6
Table 2.3	Fractional Bone Distribution by Region	8
Table 2.4	Bone Marrow Distribution in Body By Age	9
Table 2.5	Tissue Weighting Factors	11
Table 2.6	Number of Gammas or Betas Released per Disintegration	12
Table 2.7	Number of Becquerel per ALI for Each Isotope	12
Table 3.1	Material Densities for Anthropomorphic Phantoms [2]	14
Table 3.2	Characteristics of Adipose Phantoms	16
Table 4.1	Effective Dose for Isotopes for 37 GBq/m^2 External Contamination (mSv/hr)	23
Table 4.2	Beta Absorbed Dose to Hands of Healthcare Provider for 37 GBq/m^2 Externally Contaminated Patient (mGy/hr)	24
Table 4.3	Time in Hours Before the Healthcare Provider's Hands Receive a 3 Gy Dose for 37 GBq/m^2 Externally Contaminated Patient	24
Table 4.4	Total Effective Dose to Healthcare Provider for 37 GBq/m^2 Externally Contaminated Patient (mSv/hr)	25
Table 4.5	Total Effective Dose to Healthcare Provider Due to Externally Contaminated Patients (mSv/hr/Bq)	25

Table 4.6	Time in Hours Before the Healthcare Provider Receives a 250 mSv Dose for 37 GBq/m ² Externally Contaminated Patient	25
Table 4.7	Inhalation Class and Fraction of Isotope in Each Compartment Six Hours after Inhalation	27
Table 4.8	Effective Dose to Healthcare Provider from Patients with Internal Contamination (μSv/hr)/ALI	37
Table 4.9	Dose to Healthcare Provider from Patient for 1 ALI Internal Contamination and 37 GBq/m ² External Contamination for ⁶⁰ Co (mSv/hr)	38
Table 4.10	Time (Hours) It Takes for Healthcare Provider to Receive 50 mSv and 250 mSv Dose from 37 GBq/m ² Externally Contaminated Patient	39
Table 4.11	Comparison of Bridges' Study and the Present Work for Dose to Patient with 37 GBq/m ² External Contamination (mSv/hr) [1]	40
Table 4.12	Comparison of Bridges' Study, Smith et al., and the Present Work for Dose to Healthcare Provider Due to Patient with 37 GBq/m ² External Contamination (mSv/hr) [1] [8]	40
Table 5.1	Dose to Patient from 37 GBq/m ² Body Surface Contamination (mSv/hr)	48
Table 5.2	Time (Hours) Before an Individual with 37 GBq/m ² of External Contamination Receives 250 mSv Dose from Gamma Dose	51
Table 5.3	Absorbed Dose and Contribution to Effective Dose from Betas to the Patient's Skin	51
Table 5.4	Effective Dose to Patient from Gammas and Betas for 37 GBq/m ² External Contamination (mSv/hr)	52
Table 5.5	Time in Hours it Takes the Patient to Receive 250 mSv Effective Dose	52
Table A.1	Composition of Polyurethane Foam [7]	54
Table A.2	Composition of Grade 304 Stainless Steel [9]	54
Table B.1	Mass of Compartments of Anthropomorphic Phantoms in Grams [2]	55
Table H.1	Effective Dose Contribution by Organ to Reference Male Patient for 37 GBq/m ² Surface Contamination (mSv/hr)	97
Table H.2	Effective Dose Contribution by Organ to Reference Female Patient for 37 GBq/m ² Surface Contamination (mSv/hr)	97
Table H.3	Effective Dose Contribution by Organ to Adipose Male Patient for 37 GBq/m ² Surface Contamination (mSv/hr)	98

Table H.4	Effective Dose Contribution by Organ to Adipose Female Patient for 37 GBq/m ² Surface Contamination (mSv/hr)	98
Table H.5	Effective Dose Contribution by Organ to Postmenopausal Adipose Female Patient for 37 GBq/m ² Surface Contamination (mSv/hr)	99
Table I.1	Effective Dose Contribution by Organ to Organs from Reference Male Patient to Reference Male Healthcare Provider for 37 GBq/m ² of Surface Contamination (mSv/hr)	100
Table I.2	Effective Dose Contribution by Organ to Organs from Reference Female Patient to Reference Male Healthcare Provider for 37 GBq/m ² of Surface Contamination (mSv/hr)	100
Table I.3	Effective Dose Contribution by Organ to Organs from Adipose Male Patient to Reference Male Healthcare Provider for 37 GBq/m ² of Surface Contamination (mSv/hr)	101
Table I.4	Effective Dose Contribution by Organ to Organs from Adipose Female Patient to Reference Male Healthcare Provider for 37 GBq/m ² of Surface Contamination (mSv/hr)	101
Table I.5	Effective Dose Contribution by Organ to Organs from Postmenopausal Adipose Female Patient to Reference Male Healthcare Provider for 37 GBq/m ² of Surface Contamination (mSv/hr)	102
Table I.6	Effective Dose Contribution by Organ to Organs from Reference Male Patient to Reference Female Healthcare Provider for 37 GBq/m ² of Surface Contamination (mSv/hr)	102
Table I.7	Effective Dose Contribution by Organ to Organs from Reference Female Patient to Reference Female Healthcare Provider for 37 GBq/m ² of Surface Contamination (mSv/hr)	103
Table I.8	Effective Dose Contribution by Organ to Organs from Adipose Male Patient to Reference Female Healthcare Provider for 37 GBq/m ² of Surface Contamination (mSv/hr)	103
Table I.9	Effective Dose Contribution by Organ to Organs from Adipose Female Patient to Reference Female Healthcare Provider for 37 GBq/m ² of Surface Contamination (mSv/hr)	104
Table I.10	Effective Dose Contribution by Organ to Organs from Postmenopausal Adipose Female Patient to Reference Female Healthcare Provider for 37 GBq/m ² of Surface Contamination (mSv/hr)	104

Table I.11	Effective Dose Contribution by Organ to Organs from Reference Male Patient to Adipose Male Healthcare Provider for 37 GBq/m ² of Surface Contamination (mSv/hr)	105
Table I.12	Effective Dose Contribution by Organ to Organs from Reference Female Patient to Adipose Male Healthcare Provider for 37 GBq/m ² of Surface Contamination (mSv/hr)	105
Table I.13	Effective Dose Contribution by Organ to Organs from Adipose Male Patient to Adipose Male Healthcare Provider for 37 GBq/m ² of Surface Contamination (mSv/hr)	106
Table I.14	Effective Dose Contribution by Organ to Organs from Adipose Female Patient to Adipose Male Healthcare Provider for 37 GBq/m ² of Surface Contamination (mSv/hr)	106
Table I.15	Effective Dose Contribution by Organ from Postmenopausal Adipose Female Patient to Adipose Male Healthcare Provider for 37 GBq/m ² of Surface Contamination (mSv/hr)	107
Table I.16	Effective Dose Contribution by Organ from Reference Male Patient to Adipose Female Healthcare Provider for 37 GBq/m ² of Surface Contamination (mSv/hr)	107
Table I.17	Effective Dose Contribution by Organ from Reference Female Patient to Adipose Female Healthcare Provider for 37 GBq/m ² of Surface Contamination (mSv/hr)	108
Table I.18	Effective Dose Contribution by Organ from Adipose Male Patient to Adipose Female Healthcare Provider for 37 GBq/m ² of Surface Contamination (mSv/hr)	108
Table I.19	Effective Dose Contribution by Organ from Adipose Female Patient to Adipose Female Healthcare Provider for 37 GBq/m ² of Surface Contamination (mSv/hr)	109
Table I.20	Effective Dose Contribution by Organ from Postmenopausal Adipose Female Patient to Adipose Female Healthcare Provider for 37 GBq/m ² of Surface Contamination (mSv/hr)	109
Table I.21	Effective Dose Contribution by Organ from Reference Male Patient to Postmenopausal Adipose Female Healthcare Provider for 37 GBq/m ² of Surface Contamination (mSv/hr)	110
Table I.22	Effective Dose Contribution by Organ from Reference Female Patient to Postmenopausal Adipose Female Healthcare Provider for 37 GBq/m ² of Surface Contamination (mSv/hr)	110

Table I.23	Effective Dose Contribution by Organ from Adipose Male Patient to Postmenopausal Adipose Female Healthcare Provider for 37 GBq/m ² of Surface Contamination (mSv/hr)	111
Table I.24	Effective Dose Contribution by Organ from Adipose Female Patient to Postmenopausal Adipose Female Healthcare Provider for 37 GBq/m ² of Surface Contamination (mSv/hr)	111
Table I.25	Effective Dose Contribution by Organ from Postmenopausal Adipose Female Patient to Postmenopausal Adipose Female Healthcare Provider for 37 GBq/m ² of Surface Contamination (mSv/hr)	112
Table J.1	Effective Dose Contribution by Organ for Reference Male Healthcare Provider from the Reference Male Patient (μ Sv/hr) /ALI	113
Table J.2	Effective Dose Contribution by Organ for Reference Male Healthcare Provider from the Reference Female Patient (μ Sv/hr) /ALI	113
Table J.3	Effective Dose Contribution by Organ for Reference Male Healthcare Provider from the Adipose Male Patient (μ Sv/hr) /ALI	114
Table J.4	Effective Dose Contribution by Organ for Reference Male Healthcare Provider from the Adipose Female Patient (μ Sv/hr) /ALI	114
Table J.5	Effective Dose Contribution by Organ for Reference Male Healthcare Provider from the Postmenopausal Adipose Female Patient (μ Sv/hr) /ALI	115
Table J.6	Effective Dose Contribution by Organ for Reference Male Healthcare Provider from the Reference Male Patient (μ Sv/hr) /ALI	115
Table J.7	Effective Dose Contribution by Organ for Reference Male Healthcare Provider from the Reference Female Patient (μ Sv/hr) /ALI	116
Table J.8	Effective Dose Contribution by Organ for Reference Male Healthcare Provider from the Adipose Male Patient (μ Sv/hr) /ALI	116
Table J.9	Effective Dose Contribution by Organ for Reference Male Healthcare Provider from the Adipose Female Patient (μ Sv/hr) /ALI	117
Table J.10	Effective Dose Contribution by Organ for Reference Male Healthcare Provider from the Postmenopausal Adipose Female Patient (μ Sv/hr) /ALI	117
Table J.11	Effective Dose Contribution by Organ for Reference Male Healthcare Provider from the Reference Male Patient (μ Sv/hr) /ALI	118
Table J.12	Effective Dose Contribution by Organ for Reference Male Healthcare Provider from the Reference Female Patient (μ Sv/hr) /ALI	118

Table J.13	Effective Dose Contribution by Organ for Reference Male Healthcare Provider from the Adipose Male Patient ($\mu\text{Sv/hr}$) /ALI	119
Table J.14	Effective Dose Contribution by Organ for Reference Male Healthcare Provider from the Adipose Female Patient ($\mu\text{Sv/hr}$) /ALI	119
Table J.15	Effective Dose Contribution by Organ for Reference Male Healthcare Provider from the Postmenopausal Adipose Female Patient ($\mu\text{Sv/hr}$) /ALI	120
Table J.16	Effective Dose Contribution by Organ for Reference Male Healthcare Provider from the Reference Male Patient ($\mu\text{Sv/hr}$) /ALI	120
Table J.17	Effective Dose Contribution by Organ for Reference Male Healthcare Provider from the Reference Female Patient ($\mu\text{Sv/hr}$) /ALI	121
Table J.18	Effective Dose Contribution by Organ for Reference Male Healthcare Provider from the Adipose Male Patient ($\mu\text{Sv/hr}$) /ALI	121
Table J.19	Effective Dose Contribution by Organ for Reference Male Healthcare Provider from the Adipose Female Patient ($\mu\text{Sv/hr}$) /ALI	122
Table J.20	Effective Dose Contribution by Organ for Reference Male Healthcare Provider from the Postmenopausal Adipose Female Patient ($\mu\text{Sv/hr}$) /ALI	122
Table J.21	Effective Dose Contribution by Organ for Reference Male Healthcare Provider from the Reference Male Patient ($\mu\text{Sv/hr}$) /ALI	123
Table J.22	Effective Dose Contribution by Organ for Reference Male Healthcare Provider from the Reference Female Patient ($\mu\text{Sv/hr}$) /ALI	123
Table J.23	Effective Dose Contribution by Organ for Reference Male Healthcare Provider from the Adipose Male Patient ($\mu\text{Sv/hr}$) /ALI	124
Table J.24	Effective Dose Contribution by Organ for Reference Male Healthcare Provider from the Adipose Female Patient ($\mu\text{Sv/hr}$) /ALI	124
Table J.25	Effective Dose Contribution by Organ for Reference Male Healthcare Provider from the Postmenopausal Adipose Female Patient ($\mu\text{Sv/hr}$) /ALI	125
Table K.1	Absorbed Dose to Organs for Reference Male Patient for 37 GBq/m ² Surface Contamination (mGy/hr)	126
Table K.2	Absorbed Dose to Organs for Reference Female Patient for 37 GBq/m ² Surface Contamination (mGy/hr)	126
Table K.3	Absorbed Dose to Organs for Adipose Male Patient for 37 GBq/m ² Surface Contamination (mGy/hr)	127

Table K.4	Absorbed Dose to Organs for Adipose Female Patient for 37 GBq/m ² Surface Contamination (mGy/hr)	127
Table K.5	Absorbed Dose to Organs for Postmenopausal Adipose Female Patient for 37 GBq/m ² Surface Contamination (mGy/hr)	128
Table L.1	Absorbed Dose to Organs for a Reference Male Healthcare Provider from Reference Male Patient for 37 GBq/m ² Surface Contamination (mGy/hr)	129
Table L.2	Absorbed Dose to Organs for a Reference Male Healthcare Provider from Reference Female Patient for 37 GBq/m ² Surface Contamination (mGy/hr)	129
Table L.3	Absorbed Dose to Organs for a Reference Male Healthcare Provider from Adipose Male Patient for 37 GBq/m ² Surface Contamination (mGy/hr)	130
Table L.4	Absorbed Dose to Organs for a Reference Male Healthcare Provider from Adipose Female Patient for 37 GBq/m ² Surface Contamination (mGy/hr)	130
Table L.5	Absorbed Dose to Organs for a Reference Male Healthcare Provider from Postmenopausal Adipose Female Patient for 37 GBq/m ² Surface Contamination (mGy/hr)	131
Table L.6	Absorbed Dose to Organs for a Reference Female Healthcare Provider from Reference Male Patient for 37 GBq/m ² Surface Contamination (mGy/hr)	131
Table L.7	Absorbed Dose to Organs for a Reference Female Healthcare Provider from Reference Female Patient for 37 GBq/m ² Surface Contamination (mGy/hr)	132
Table L.8	Absorbed Dose to Organs for a Reference Female Healthcare Provider from Adipose Male Patient for 37 GBq/m ² Surface Contamination (mGy/hr)	132
Table L.9	Absorbed Dose to Organs for a Reference Female Healthcare Provider from Adipose Female Patient for 37 GBq/m ² Surface Contamination (mGy/hr)	133
Table L.10	Absorbed Dose to Organs for a Reference Female Healthcare Provider from Postmenopausal Adipose Female Patient for 37 GBq/m ² Surface Contamination (mGy/hr)	133
Table L.11	Absorbed Dose to Organs for an Adipose Male Healthcare Provider from Reference Male Patient for 37 GBq/m ² Surface Contamination (mGy/hr)	134
Table L.12	Absorbed Dose to Organs for an Adipose Male Healthcare Provider from Reference Female Patient for 37 GBq/m ² Surface Contamination (mGy/hr)	134
Table L.13	Absorbed Dose to Organs for an Adipose Male Healthcare Provider from Adipose Male Patient for 37 GBq/m ² Surface Contamination (mGy/hr)	135

Table L.14	Absorbed Dose to Organs for an Adipose Male Healthcare Provider from Adipose Female Patient for 37 GBq/m ² Surface Contamination (mGy/hr)	135
Table L.15	Absorbed Dose to Organs for an Adipose Male Healthcare Provider from Postmenopausal Adipose Female Patient for 37 GBq/m ² Surface Contamination (mGy/hr)	136
Table L.16	Absorbed Dose to Organs for an Adipose Female Healthcare Provider from Reference Male Patient for 37 GBq/m ² Surface Contamination (mGy/hr)	136
Table L.17	Absorbed Dose to Organs for an Adipose Female Healthcare Provider from Reference Female Patient for 37 GBq/m ² Surface Contamination (mGy/hr)	137
Table L.18	Absorbed Dose to Organs for an Adipose Female Healthcare Provider from Adipose Male Patient for 37 GBq/m ² Surface Contamination (mGy/hr)	137
Table L.19	Absorbed Dose to Organs for an Adipose Female Healthcare Provider from Adipose Female Patient for 37 GBq/m ² Surface Contamination (mGy/hr)	138
Table L.20	Absorbed Dose to Organs for an Adipose Female Healthcare Provider from Postmenopausal Adipose Female Patient for 37 GBq/m ² Surface Contamination (mGy/hr)	138
Table L.21	Absorbed Dose to Organs for a Postmenopausal Adipose Female Healthcare Provider from Reference Male Patient for 37 GBq/m ² Surface Contamination (mGy/hr)	139
Table L.22	Absorbed Dose to Organs for a Postmenopausal Adipose Female Healthcare Provider from Reference Female Patient for 37 GBq/m ² Surface Contamination (mGy/hr)	139
Table L.23	Absorbed Dose to Organs for a Postmenopausal Adipose Female Healthcare Provider from Adipose Male Patient for 37 GBq/m ² Surface Contamination (mGy/hr)	140
Table L.24	Absorbed Dose to Organs for a Postmenopausal Adipose Female Healthcare Provider from Adipose Female Patient for 37 GBq/m ² Surface Contamination (mGy/hr)	140
Table L.25	Absorbed Dose to Organs for a Postmenopausal Adipose Female Healthcare Provider from Postmenopausal Adipose Female Patient for 37 GBq/m ² Surface Contamination (mGy/hr)	141
Table M.1	Absorbed Dose to Organs for a Reference Male Healthcare Provider from Reference Male Patient for Internal Contamination (μGy/hr)/ALI	142
Table M.2	Absorbed Dose to Organs for a Reference Male Healthcare Provider from Reference Female Patient for Internal Contamination (μGy/hr)/ALI	142

Table M.3	Absorbed Dose to Organs for a Reference Male Healthcare Provider from Adipose Male Patient for Internal Contamination ($\mu\text{Gy/hr}$)/ALI	143
Table M.4	Absorbed Dose to Organs for a Reference Male Healthcare Provider from Adipose Female Patient for Internal Contamination ($\mu\text{Gy/hr}$)/ALI	143
Table M.5	Absorbed Dose to Organs for a Reference Male Healthcare Provider from Postmenopausal Adipose Female Patient for Internal Contamination ($\mu\text{Gy/hr}$)/ALI	144
Table M.6	Absorbed Dose to Organs for a Reference Female Healthcare Provider from Reference Male Patient for Internal Contamination ($\mu\text{Gy/hr}$)/ALI	144
Table M.7	Absorbed Dose to Organs for a Reference Female Healthcare Provider from Reference Female Patient for Internal Contamination ($\mu\text{Gy/hr}$)/ALI	145
Table M.8	Absorbed Dose to Organs for a Reference Female Healthcare Provider from Adipose Male Patient for Internal Contamination ($\mu\text{Gy/hr}$)/ALI	145
Table M.9	Absorbed Dose to Organs for a Reference Female Healthcare Provider from Adipose Female Patient for Internal Contamination ($\mu\text{Gy/hr}$)/ALI	146
Table M.10	Absorbed Dose to Organs for a Reference Female Healthcare Provider from Postmenopausal Adipose Female Patient for Internal Contamination ($\mu\text{Gy/hr}$)/ALI	146
Table M.11	Absorbed Dose to Organs for a Adipose Male Healthcare Provider from Reference Male Patient for Internal Contamination ($\mu\text{Gy/hr}$)/ALI	147
Table M.12	Absorbed Dose to Organs for a Adipose Male Healthcare Provider from Reference Female Patient for Internal Contamination ($\mu\text{Gy/hr}$)/ALI	147
Table M.13	Absorbed Dose to Organs for a Adipose Male Healthcare Provider from Adipose Male Patient for Internal Contamination ($\mu\text{Gy/hr}$)/ALI	148
Table M.14	Absorbed Dose to Organs for a Adipose Male Healthcare Provider from Adipose Female Patient for Internal Contamination ($\mu\text{Gy/hr}$)/ALI	148
Table M.15	Absorbed Dose to Organs for a Adipose Male Healthcare Provider from Postmenopausal Adipose Female Patient for Internal Contamination ($\mu\text{Gy/hr}$)/ALI	149
Table M.16	Absorbed Dose to Organs for a Adipose Female Healthcare Provider from Reference Male Patient for Internal Contamination ($\mu\text{Gy/hr}$)/ALI	149
Table M.17	Absorbed Dose to Organs for a Adipose Female Healthcare Provider from Reference Female Patient for Internal Contamination ($\mu\text{Gy/hr}$)/ALI	150

Table M.18 Absorbed Dose to Organs for a Adipose Female Healthcare Provider from Adipose Male Patient for Internal Contamination ($\mu\text{Gy/hr}$)/ALI	150
Table M.19 Absorbed Dose to Organs for a Adipose Female Healthcare Provider from Adipose Female Patient for Internal Contamination ($\mu\text{Gy/hr}$)/ALI	151
Table M.20 Absorbed Dose to Organs for a Adipose Female Healthcare Provider from Postmenopausal Adipose Female Patient for Internal Contamination ($\mu\text{Gy/hr}$)/ALI	151
Table M.21 Absorbed Dose to Organs for a Postmenopausal Adipose Female Healthcare Provider from Reference Male Patient for Internal Contamination ($\mu\text{Gy/hr}$)/ALI	152
Table M.22 Absorbed Dose to Organs for a Postmenopausal Adipose Female Healthcare Provider from Reference Female Patient for Internal Contamination ($\mu\text{Gy/hr}$)/ALI	152
Table M.23 Absorbed Dose to Organs for a Postmenopausal Adipose Female Healthcare Provider from Adipose Male Patient for Internal Contamination ($\mu\text{Gy/hr}$)/ALI	153
Table M.24 Absorbed Dose to Organs for a Postmenopausal Adipose Female Healthcare Provider from Adipose Female Patient for Internal Contamination ($\mu\text{Gy/hr}$)/ALI	153
Table M.25 Absorbed Dose to Organs for a Postmenopausal Adipose Female Healthcare Provider from Postmenopausal Adipose Female Patient for Internal Contamination ($\mu\text{Gy/hr}$)/ALI	154

LIST OF FIGURES

Figure 2.1	Three-Dimensional Representation of Adipose Female Healthcare Provider and Reference Male Patient	5
Figure 2.2	Two-Dimensional Representation of Reference Male Healthcare Provider and Reference Female Patient	5
Figure 3.1	Graphic of Reference Male	15
Figure 3.2	Graphic of Reference Female	15
Figure 3.3	Graphic of Adipose Male	17
Figure 3.4	Graphic of Adipose Female	17
Figure 3.5	Graphic of Postmenopausal Adipose Female	18
Figure 4.1	Healthcare Provider Effective Dose Due to 37 GBq/m ² of External Contamination of ¹³⁷ Cs on the Patient	22
Figure 4.2	Effective Dose Rate Due to Healthcare Provider Due to ⁶⁰ Co (slow)	29
Figure 4.3	Effective Dose Rate Due to Healthcare Provider Due to ⁶⁰ Co (moderate)	30
Figure 4.4	Effective Dose Rate Due to Healthcare Provider Due to ²⁴¹ Am	30
Figure 4.5	Effective Dose Rate Due to Healthcare Provider Due to ¹⁹² Ir (slow)	32
Figure 4.6	Effective Dose Rate Due to Healthcare Provider Due to ¹⁹² Ir (moderate)	32
Figure 4.7	Effective Dose Rate Due to Healthcare Provider Due to ¹⁹² Ir (fast)	33
Figure 4.8	Effective Dose Rate Due to Healthcare Provider Due to ¹³⁷ Cs	34
Figure 4.9	Effective Dose Rate Due to Healthcare Provider Due to ¹³¹ I	35
Figure 5.1	The Percentage of the Effective Dose Contributions by Organ for the Reference Male	42
Figure 5.2	The Percentage of the Effective Dose Contributions by Organ for the Reference Female	43
Figure 5.3	The Percentage of the Effective Dose Contributions by Organ for the Adipose Male	45

Figure 5.4	The Percentage of the Effective Dose Contributions by Organ for the Adipose Female	46
Figure 5.5	The Percentage of the Effective Dose Contributions by Organ for the Postmenopausal Adipose Female	47
Figure 5.6	Effective Dose Contributions for Each Anthropomorphic Phantom from 37 GBq/m ² External Contamination of ⁶⁰ Co (mSv/hr)	49
Figure 5.7	Effective Dose Contributions to Organs for Each Anthropomorphic Phantom from 37 GBq/m ² External Contamination of ²⁴¹ Am (mSv/hr)	50

SUMMARY

A device which releases radioactive material for the purpose of causing terror, such as a dirty bomb, is known as a radiological dispersal device (RDD). The purpose of this study is to determine the dose to healthcare providers due to both internally and externally contaminated patients and the dose to the patient due to external contamination subsequent to an RDD event.

Monte Carlo calculations were performed to simulate healthcare workers in the operating room or trauma room at a hospital. The Monte Carlo Neutral Particle transport code MCNP5 was used for the modeling. The human body was modeled using Medical Internal Radiation Dose (MIRD-V) anthropomorphic phantoms originally developed at Oak Ridge National Laboratory (ORNL) under the specifications of International Commission on Radiation Protection (ICRP) Publication 23 and later altered at Georgia Tech [17].

This study considered two possible contamination scenarios: uniform external contamination with no internal contamination and inhaled radioactive material without any external contamination. For both scenarios, the patients isotopes considered were ^{60}Co , ^{137}Cs , ^{131}I , ^{192}Ir , and ^{241}Am . For the externally contaminated patient, a uniform volume source two millimeters thick was placed around the skin of each anthropomorphic phantom to simulate a uniform source on the surface of the body. For the internally contaminated patients, the Dose and Risk Calculation software, DCAL, was used to determine the distribution of the isotopes in the internal organs. For both of the scenarios, the healthcare provider was placed 20-cm from the middle of the torso of the contaminated patient.

The amount of energy deposited to the tissues and organs of the healthcare provider due to the internally and externally contaminated patients and in the patient in the case of external

contamination was determined. The effective dose rate was calculated using the masses of the tissues and organ and tissue weighting factors from ICRP Publication 60.

The effective dose rate for the healthcare provider for internally and externally contaminated patients are given in Table I and Table II after averaging over the five phantoms used in the modeling. The internal contamination level is based on one Annual Limit on Intake (ALI) and the external contamination level was taken to be 37 GBq/m². The effective dose to an externally contaminated patient depending on the patient's body type is shown in Table III.

Table I Effective Dose to the Healthcare Provider for Internal Contamination of the Patient
($\mu\text{Sv/hr}$)/ALI

Healthcare Provider	⁶⁰ Co (m)	⁶⁰ Co (s)	¹⁹² Ir (f)	¹⁹² Ir (m)	¹⁹² Ir (s)	²⁴¹ Am	¹³⁷ Cs	¹³¹ I
Reference Male	0.7	2.1	1.3	1.6	4.1	3.24E-06	1.12	0.38
Reference Female	0.7	2.2	1.4	1.7	4.4	3.60E-06	1.21	0.43
Adipose Male	0.6	1.7	0.9	1.1	3.1	1.97E-06	0.91	0.30
Adipose Female	0.6	1.8	1.0	1.3	3.5	2.38E-06	0.95	0.32
Postmenopausal Adipose Female	0.6	1.9	1.0	1.3	3.4	2.16E-06	0.97	0.32
Average	0.6	2.0	1.1	1.4	3.7	2.67E-06	1.03	0.35
Standard Deviation	0.1	0.2	0.2	0.2	0.5	7.46E-07	0.14	0.05

Table II Average Effective Dose to the Healthcare Provider for a 37 GBq/m² External Contamination of the Patient (mSv/hr)

Healthcare Provider	⁶⁰ Co	¹⁹² Ir	²⁴¹ Am	¹³⁷ Cs	¹³¹ I
Reference Male	30.2	12.8	0.4	7.7	4.7
Reference Female	31.6	13.6	0.4	8.1	5.0
Adipose Male	25.2	9.6	0.2	6.1	3.6
Adipose Female	27.1	10.7	0.3	6.7	4.0
Postmenopausal Adipose Female	29.6	10.9	0.3	6.9	4.0
Average	28.5	11.5	0.3	7.1	4.2
Standard Deviation	3.2	1.8	0.1	0.9	0.6

Table III Dose to Patient from 37 GBq/m² External Contamination (mSv/hr)

Patient	⁶⁰ Co	¹⁹² Ir	²⁴¹ Am	¹³⁷ Cs	¹³¹ I
Reference Male	197	75.5	2.61	48.6	28.2
Reference Female	167	64.3	2.32	41.2	24
Adipose Male	199	78.1	2.94	49.3	29
Adipose Female	173	67	2.3	42.6	24.9
Postmenopausal Adipose Female	181	70.3	2.29	44.3	26
Average	183.4	71.0	2.5	45.2	26.4
Standard Deviation	14.2	5.7	0.3	3.6	2.1

The time it takes to receive the NRC dose limit for radiation workers (50mSv) and the EPA guidelines for lifesaving (250mSv) is sufficient for the stabilization of a patient with life-threatening injuries prior to decontamination. For a patient externally contaminated with 37GBq/m² of ⁶⁰Co, the healthcare provider receives a 250 mSv in 8.3 hours. The externally contaminated patient would receive 1581 mSv in 8.3 hours.

CHAPTER 1

INTRODUCTION

A radiological dispersal device (RDD) is a device which deliberately releases radioactive material for the purpose of causing terror or harm. One example of such a device is a dirty bomb. A dirty bomb is fabricated by combining explosives and radioactive material. In the event that a dirty bomb is detonated, there may be airborne radioactive material that can be inhaled or ingested as well as settle on an individual leading to external contamination. The number of contaminated patients will depend on many factors, but contaminated individuals requiring immediate medical attention can deliver dose to healthcare professionals as well as themselves.

For the patients requiring medical attention, the healthcare industry is concerned with the dose received by healthcare providers while exposed to contaminated patients. The dose to the patient due to external contamination will first be determined. The dose to the healthcare provider, or individual spending time very close to the patient such as in the operating room, treating the externally contaminated patient will then be determined. Because an RDD allows for the possibility that radioactive material may have also been inhaled by the patient, the effective dose rate the healthcare provider receives per ALI inhaled by the patient will also be determined.

Comparisons of the results for this study, Bridges' study [1] and Smith et al. [8] to determine the accuracy of the results. Bridges' results for the dose to the patient and the dose to the healthcare provider are shown in Tables 1.1 and 1.2, respectively. The results from Smith et al. are shown in Table 1.3.

Table 1.1 Dose to the Patient from Bridges' Study (mSv/hr) [1]

Patient	⁶⁰Co	¹⁹²Ir	²⁴¹Am	¹³⁷Cs	¹³¹I
Reference Male	270	90.9	2.8	66.9	41.6
Reference Female	233	77.9	2.44	57.4	35.7
Adipose Male	219	74	2.32	48	30.5

Table 1.2 Dose to the Healthcare Provider from Bridges' Study (mSv/hr) [1]

Healthcare Provider / Patient	⁶⁰Co	¹⁹²Ir	²⁴¹Am	¹³⁷Cs	¹³¹I
Reference Male / Reference Male	41.9	15.3	0.49	10.7	6.99
Reference Female / Reference Female	37	13.4	0.426	9.44	6.08
Adipose Male / Adipose Male	28.2	9.32	0.275	7.04	5.03
Reference Male / Adipose Male	44.2	16.2	0.529	11.4	7.42

Table 1.3 Dose to the Healthcare Provider from Smith et al. (mSv/hr) [8]

⁶⁰Co	¹⁹²Ir	²⁴¹Am	¹³⁷Cs	¹³¹I
39	15	0.66	10	--

CHAPTER 2

METHODS

There are many variables contributing to the dose received by a healthcare provider after an RDD. The level of contamination of the patient, for both internal and external contamination, is the major factor. The dose to healthcare providers is dependent on the type of contamination, whether internal or external. The body type of both the patient and the healthcare provider are also contributing factors. For external contamination, the surface area of the patient increases the total amount of radioactive material present. For internal contamination, the distribution in the body can affect the dose to the healthcare provider.

Six isotopes were considered for possible use in an RDD: ^{60}Co , ^{192}Ir , ^{241}Am , ^{137}Cs , and ^{131}I . The principal gamma-ray and average beta energies in addition to their corresponding intensities for each of the aforementioned isotopes are shown in Table 2.1.

Table 2.1 Radioisotope Energies and Intensities

	^{60}Co	^{137}Cs	^{131}I	^{192}Ir	^{241}Am
γ-ray Energy (keV)	1173, 1333	662	364.5, 637	296-612	59.5
γ-ray Intensity	1, 1	0.851	0.812, 0.073	2.13	0.359
Average β Energy (keV)	96	173, 425	192, 97, 69	209, 161, 71	---
β Intensity	0.999	0.946, 0.054	0.894, 0.074, 0.021	0.415, 0.481, 0.056	---

2.1 Monte Carlo Simulations

The Monte Carlo simulations are carried out using Monte Carlo Neutral Particle transport code version 5 (MCNP5) [11]. MCNP is a stochastic stimulation code, and is used to model human anthropomorphic phantoms [11]. Five anthropomorphic phantoms are employed for this study: a reference male, a reference female, an adipose male, an adipose female, and a postmenopausal adipose female. The phantoms originally are all based on ICRP 23 Reference Man Publication and MIRD-V phantoms [2]. The source of the MCNP representations used as a starting point were developed at PNNL in the 1990's and have been altered at Georgia Tech.

The setup for the trauma room is the same for all simulations. The surface of the healthcare provider is positioned 20-cm away from the midsection of the patient. The midsection of the patient was chosen instead of the head or feet due to the solid angle of the source the healthcare provider will see, providing a conservative estimate of the dose to the healthcare provider [1]. The patient is placed at the midsection of the healthcare provider laying flat on their back on top of an operating table. The operating table, which is based on a suture table at Georgia Tech Health Center, is 198.12-cm long and 68.58-cm wide. The top layer of the operating table is composed of a 7.62-cm thick piece of polyurethane foam on top of a 12-gage thick sheet of stainless steel. The composition of the polyurethane foam [7] and stainless steel 304 [9] are shown in Tables A.1 and A.2, respectively. A three-dimensional and a two-dimensional representation of the setup are shown in Figures 2.1 and 2.2, respectively.

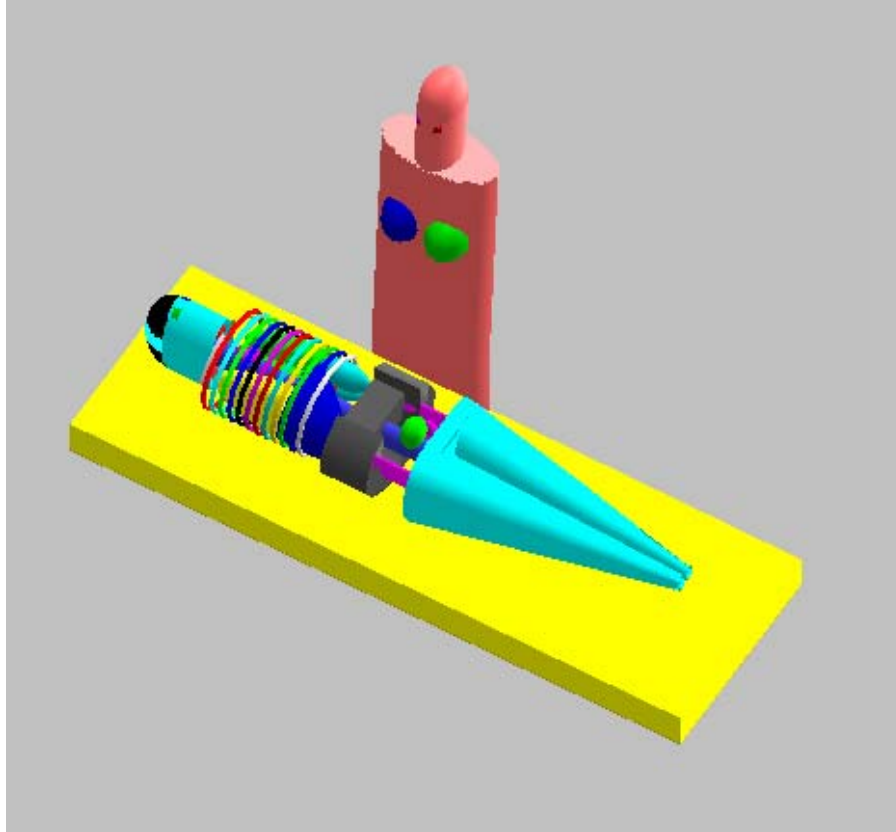

Figure 2.1 Three-Dimensional Representation of Adipose Female Healthcare Provider and Reference Male Patient.

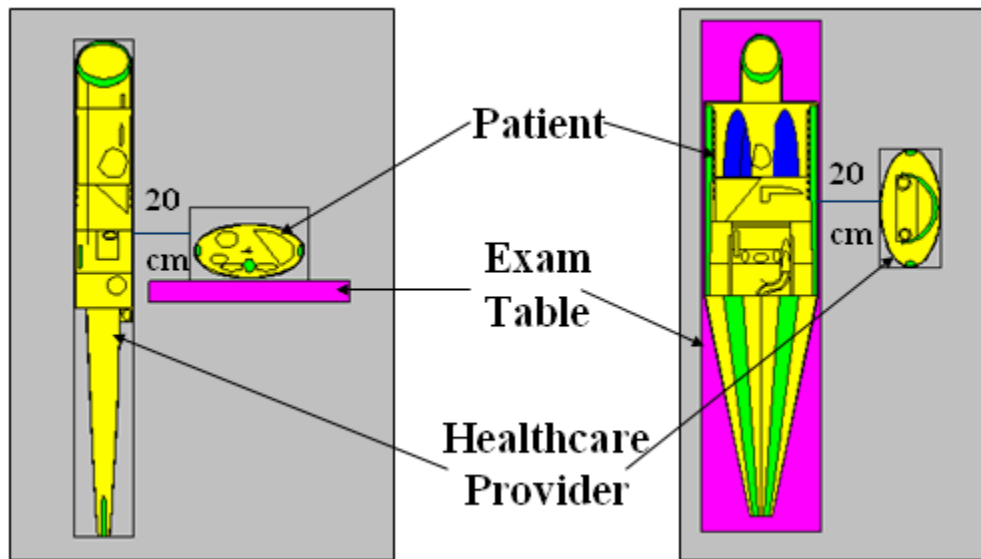

Figure 2.2 Two-Dimensional Representation of Reference Male Healthcare Provider and Reference Female Victim

Two separate sets of simulations were performed for each phantom and each isotope: one for externally contaminated patients and the other for internally contaminated patients. In order to simulate the external contamination on the anthropomorphic phantoms, a uniform volume source was created in a 2-mm thick cell adjacent to the skin layer. A model of each phantom was created for each of the sources. According to explosives tests conducted at Sandi National Laboratories Explosives Test Center, a patient that could survive the explosion of a dirty bomb could have a maximum contamination level ranging from 3.7 GBq/m² to 37.0 GBq/m² (10-100μCi/cm²) [8]. A uniform contamination level of 37.0 GBq/m² will be considered in this study since any other uniform contamination level only requires scaling of the dose rate. In order to determine the total source strength of the patient, the surface area of the skin for each anthropomorphic phantom is needed and is given in Table 2.2. The surface area of the reference male and reference female were obtained from ICRP Publication 23 [2]. Since the thickness of the skin was constant for all phantoms, the surface area of the adipose phantoms was determined by taking the ratio of the volume of the adipose phantom to the reference phantom and multiplying it by the surface area of the reference phantom. The externally contaminated anthropomorphic phantoms were used to determine the dose to the patient and the dose to the healthcare provider.

Table 2.2 Surface Area of Skin for Anthropomorphic Phantoms

Phantom	Surface Area
Reference Male	1.800 m ²
Reference Female	1.635 m ²
Adipose Male	2.520 m ²
Adipose Female	2.013 m ²
Postmenopausal Adipose Female	2.148 m ²

The second set of simulations was completed using internally contaminated phantoms as the patients. In order to determine where to properly distribute each isotope inside the phantom, the DCAL program [12] was used to track the movement of radionuclides through the body after inhalation as a function of time. DCAL requires the inhalation class of the isotope to determine the appropriate percentage of the amount of radioactive material initially inhaled to be deposited in each compartment of the body. The inhalation class is determined according to the rate of clearance of the material from the pulmonary region of the lungs. The inhalation class for each of the isotopes was determined using Rad Toolbox [13]. For the simulations presented herein, the isotope distributions in the patients were determined for a post-inhalation time of six hours.

Further compartmentalization of the output from DCAL for some of the larger organs including the blood, bone surface, bone volume, red bone marrow, body tissue, upper large intestine, lower large intestine and “other” needed to be performed before the source definitions could be completed. According to ICRP 23, 10% of the blood is located in the heart [2]. Since the heart was not one of the main organs listed in the DCAL output, this fraction of the radioactive material in the blood was placed in the heart. The remaining 90% of the radioactive material in the blood was added to the contents in the body tissue and “other” categories. It was assumed that the DCAL output for organs, such as the liver which contains a large amount of blood but were already included as a separate organ in the DCAL output, contained the total radiation present in that organs, so no additional radioactive material was added to these organs. This total was distributed to the different cells containing body tissue on a fractional weight basis.

The bone categories were distributed differently. The distribution of bone and bone marrow in the body were obtained from ICRP 23 and is shown in Tables 2.3 and 2.4,

respectively [2]. The isotope in the bone surface and the bone volume categories were summed. The fraction of radioactive material present in each of the phantom skeletal regions was determined from the DCAL output using the distributions. The sum of the contribution due to the bone and the bone marrow were added to each of the phantom skeletal regions. Additionally the upper large intestine was split into the ascending and transverse colon, and the lower large intestine was split into the sigmoid and descending colon using the fractional weight of each compartment according to ICRP 23 [2]. All of the simplified compartmentalized fractions from DCAL were then used to create the sources within the anthropomorphic phantoms. The internal contamination of the patients were completed by making individual sources in each internal compartment and entering the fraction of the radioactive material present after six hours for each of the isotopes and each of the phantoms.

Table 2.3 Fractional Bone Distribution by Region

Phantom Skeletal Region	Fraction
Legs	0.3568
Arms	0.1592
Spine	0.1098
Pelvis	0.0784
Skull	0.1412
Ribs	0.1530

Table 2.4 Bone Marrow Distribution in Body by Age

Phantom Skeletal Region	10-Year-Old Androgynous Child	Adult
Skull	0.1272	0.0832
Scapulae	0.0289	0.0285
Clavicles	0.0089	0.0079
Ribs	0.1302	0.1922
Spine (upper)	0.227	0.2986
Pelvis	0.2873	0.3332
Legs	0.1637	0.0335
Arms	0.0268	0.0229

2.2 Dose Calculations

The dose calculation is completed in accordance with ICRP 60 [3]. A tally of the energy deposited in the cell (*F8 tally in MCNP parlance) was used to determine amount of energy in MeV per source particle deposited in each compartment of the body. A tally of only the photon energy was taken since the *F8 tally for photons, for electrons, and for photons and electrons are equivalent in MCNP. MCNP tallies both electron and photons if present, even if only requested to tally one or the other [11]. The mass of each compartment was obtained from ICRP 23 and are shown in Appendix B. To compute the effective dose, it is necessary to tally over each organ independently. The tissue weighting factors obtained from ICRP 60 [3] are used to create a weighted sum of these organ doses. They are shown in Table 2.5 and account for the different radiosensitivities of different compartments of the human body. The energy-deposition tally for each organ were divided by the mass of that organ then multiplied by the appropriate tissue weighting factor. Due to the inability to split the tally of the bone into bone surface and red bone marrow, the tally for the bone was split into two sections based on the fraction of the total bone mass that makes up the bone surface and the red bone marrow. The weighting factors for these

components were then applied to these sections. The tallies for the colon wall were broken into four components: ascending colon, transverse colon, sigmoid colon and descending colon.

These sections were divided by the mass of the wall of each section prior to being summed and multiplied by the tissue weighting factor. The remainder is composed of muscle, uterus, brain, heart, small intestines, kidneys, spleen, pancreas, thymus, and the adrenal glands. The dose to the remainder is determined in the same fashion as that used for determining the dose to the colon wall. To obtain the effective dose rate per source particle, the sum of the dose rate to the individual organs was summed as shown by Equations 2.1 and 2.2.

$$E = \sum_T H_T \quad [2.1]$$

$$H_T = \sum_R w_R D_{T,R} \quad [2.2]$$

Where:

H_T = equivalent organ dose (Sv)

w_R = radiation weighting factor

$D_{T,R}$ = absorbed dose averaged over the tissue or organ T, due to radiation R (Gy)

Table 2.5 Tissue Weighting Factors [3]

Organ	Tissue Weighting Factor
Gonads	0.2
Stomach	0.12
Colon	0.12
Bladder	0.05
Lungs	0.12
Bone	0.13
Liver	0.05
Thyroid	0.05
Esophagus	0.05
Skin	0.01
Other	0.05
Breast	0.05

For the internal contamination of the patient, obtaining the effective dose rate to the healthcare professional per ALI inhaled by the patient is the quantity of interest. The annual limit on intake or ALI is defined as the amount of intake of a specific radionuclide resulting in the reference male receiving a committed effective dose equivalent of 0.05 Sievert or a committed dose equivalent of 0.5 Sievert to any organ or tissue [10]. The ALI for each isotope was determined using the ICRP 72 public inhalation dose coefficients [20]. The previously determined effective dose rate per source particle per organ is multiplied by the number of gammas or betas released per disintegration and the number of Becquerel per ALI. These values are shown in Tables 2.6 and Table 2.7, respectively. The effective dose equivalent per ALI will allow the healthcare industry to determine the dose to a healthcare provider as a function of intake by a patient.

Table 2.6 Number of Gammas or Betas Released per Disintegrations

Isotope	Gammas/Betas Per Disintegration
²⁴¹ Am	0.9708
¹³⁷ Cs	0.9585
⁶⁰ Co	2
¹⁹² Ir	2.13
¹³¹ I	1

Table 2.7 Number of Becquerel per ALI for Each Isotope

Isotope	Bq/ALI
²⁴¹ Am	1.19E+03
¹³⁷ Cs	1.09E+07
⁶⁰ Co (slow)	1.61E+06
⁶⁰ Co (moderate)	5.00E+06
¹⁹² Ir (slow)	7.57E+06
¹⁹² Ir (moderate)	9.61E+06
¹⁹² Ir (fast)	2.78E+07
¹³¹ I	6.76E+06

The dose from an externally contaminated patient to themselves and to the healthcare provider is determined in a slightly different manner. A uniform volume source was placed over the entire skin layer of the phantom. Using the information available from the explosive testing conducted at Sandi National Laboratories Explosive Test Center, potential contamination levels ranging from 3.7 to 37 GBq/m² may be expected for patients sustaining life-threatening injuries after an RDD [8]. In order to obtain a conservative estimate, 37 GBq/m² was used. Any other contamination level can be determined by scaling the results of the study. This level was multiplied by the dose rate per source particle, the surface area of the phantoms, and the number

of photons or betas emitted per disintegration to determine the effective dose rate to both the patient and the healthcare provider.

CHAPTER 3

ANTHROPOMORPHIC PHANTOMS

Six different anthropomorphic phantoms were used for this study: reference male, reference female, adipose male, adipose female, post-menopausal adipose female, and a ten-year-old androgynous child. Depending on the end use of the phantoms, additional features were added to the models. All of the adult phantoms were employed in both the trauma room scenario.

3.1 Reference Male and Reference Female Phantoms

The reference male and reference female MCNP models were originally developed at Pacific Northwest National Laboratory (PNNL) from the MIRD representation and the ICRP 23 descriptions [14]. The reference male, shown in Figure 3.1, weighs 71.7 kg, is 170-cm tall and has a Body Mass Index (BMI) of 20. The BMI is determined by dividing the weight in kilograms by the square of the height in meters. The reference female, shown in Figure 3.2, is 164-cm tall, weighs 58.9 kg and has a BMI of 23. The material densities used for the phantoms are in Table 3.1.

Table 3.1 Material Densities for Anthropomorphic Phantoms (g/cm^3) [2]

Adult Tissue	1.04
Skeleton	1.4
Lung	0.29
Air	0.001293

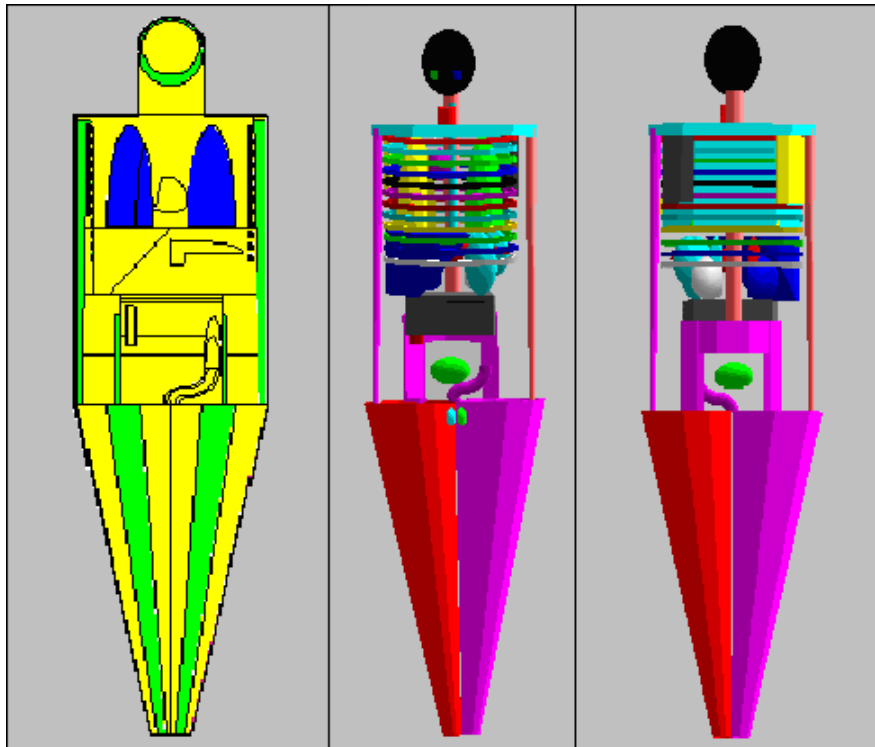

Figure 3.1 Graphic of Reference Male

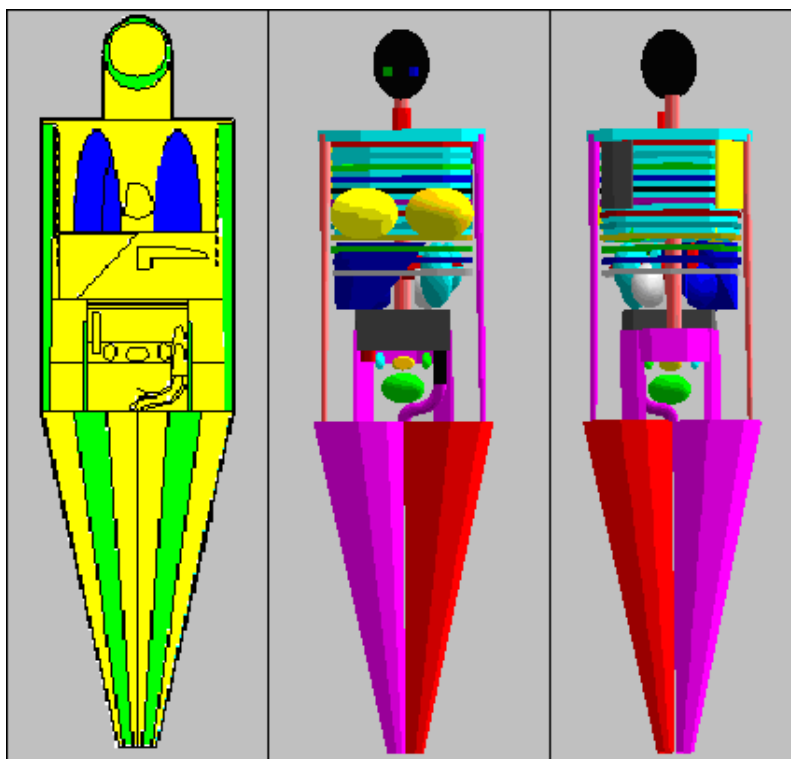

Figure 3.2 Graphic of Reference Female

The PNNL MCNP models did not contain skin, so the addition of a skin layer was necessary. Previously an esophagus and colon walls were added to these phantoms at Georgia Tech by Simpkins and Hertel [6]. Using ICRP 23, it was determined that the average thickness human skin was approximately 2-mm [2]. Thus, a 2-mm thick skin layer was added to the outside of the phantom. An additional 2-mm thick layer was added to the outside of the skin so that a uniform volume source could be added to the outside of each phantom in order to approximate a surface source due to external contamination. The input files for the reference male and reference female phantoms can be found in Appendix C and D, respectively.

3.2 Adipose Male, Adipose Female and Post-Menopausal Adipose Female Phantoms

The adipose male, adipose female and post-menopausal adipose female phantoms were developed by Simpkins and Hertel [6]. The adipose phantoms were obtained by modifying the MCNP reference phantom models developed at PNNL to contain adipose tissue as explained in Table 3.2 [6]. Figures 3.3 through 3.5 depict the adipose male, adipose female and post-menopausal adipose female, respectively.

Table 3.2 Characteristics of Adipose Phantoms

	Adipose Male	Adipose Female	Post-Menopausal Adipose Female
Total Weight	93.7 kg	73.9 kg	85.9 kg
Adipose Weight	22 kg	15 kg	27 kg
BMI	30	26	30

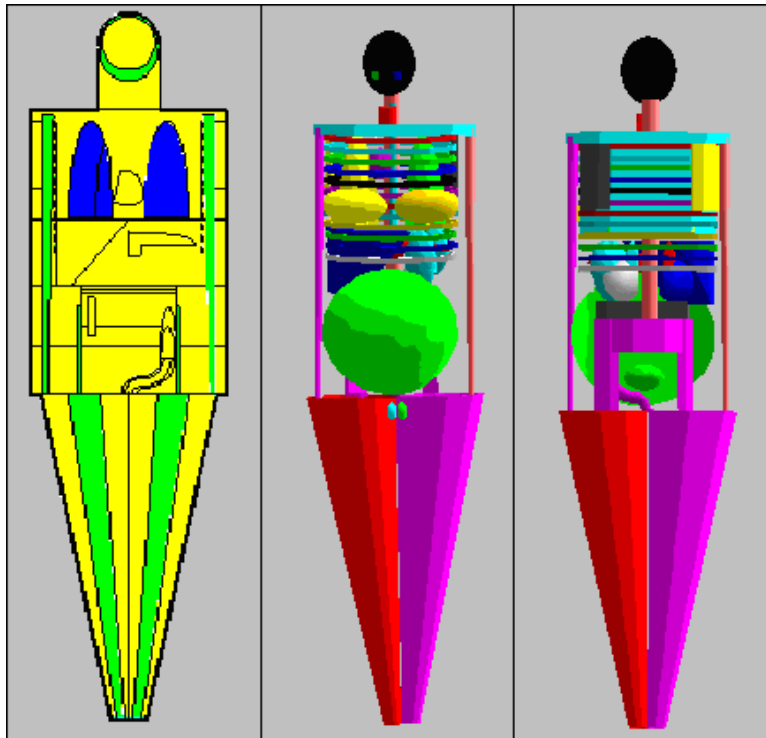

Figure 3.3 Graphic of Adipose Male

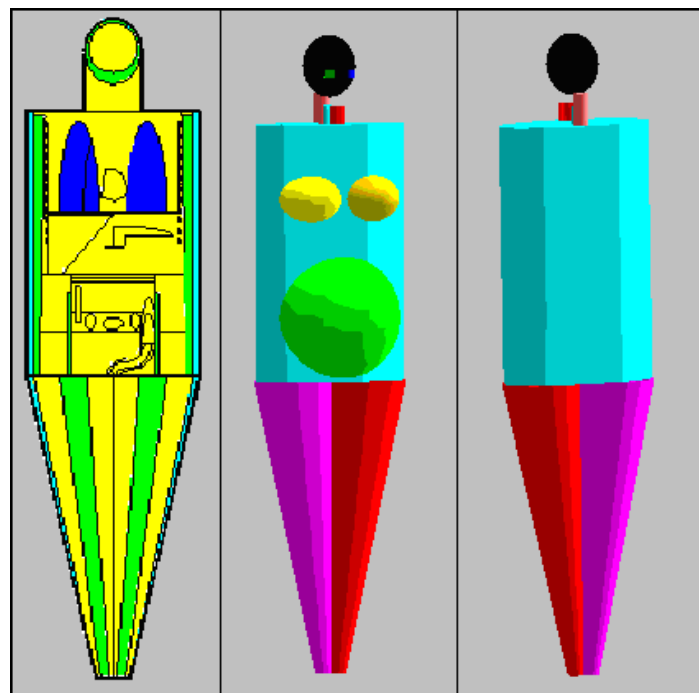

Figure 3.4 Graphic of Adipose Female

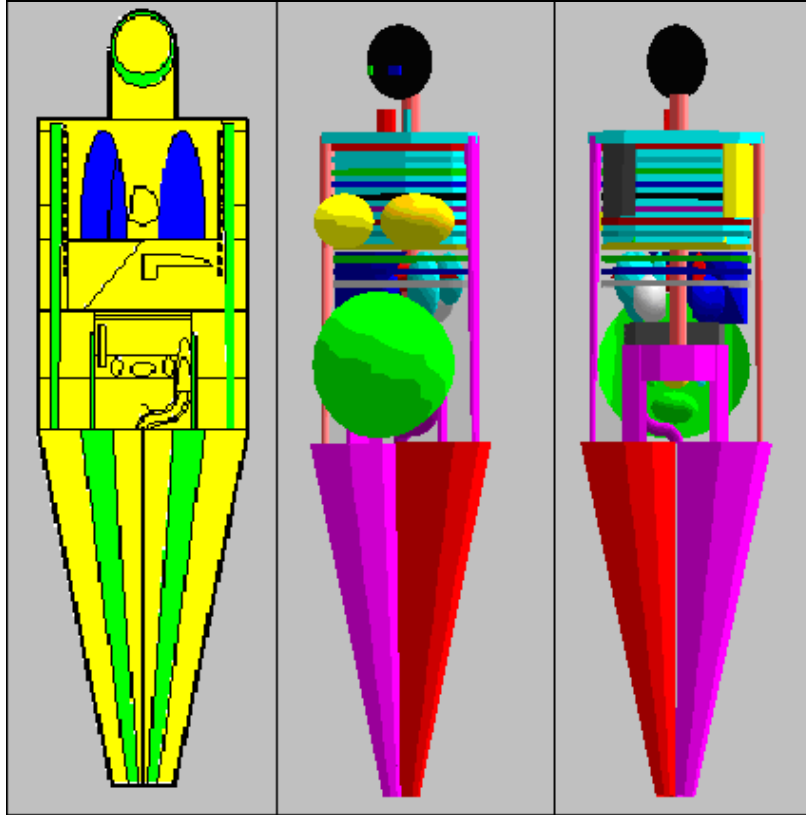

Figure 3.5 Graphic of Postmenopausal Adipose Female

For the purpose of this study, a layer of skin was added to the adipose phantoms in a similar fashion as the reference phantoms. ICRP 23 does not contain different skin thickness values for reference versus adipose phantoms, so it was assumed that the skin thickness for the adipose phantoms was approximately the same as that for the reference phantoms. The additional 2-mm thick cell was also added to the adipose phantoms for the same purpose as that for the reference phantoms. The input files for the adipose male, adipose female and postmenopausal adipose female phantoms can be found in Appendix E, F and G, respectively.

CHAPTER 4

DOSE TO HEALTHCARE PROVIDER

The effective dose rate to the healthcare provider is of concern to the healthcare industry because it helps determine the amount of time a healthcare provider can be in contact with the patients. There are two main scenarios of concern: patients that are externally contaminated and cannot be decontaminated prior to treatment and the patients that are internally contaminated. The effects of body type of both the patient and the healthcare provider for the isotopes of concern will be considered.

According to the NRC, the annual dose limit for a radiation worker is 50 mSv/yr [16]. The National Council on Radiation Protection and Measurements allow for a one-time, whole body effective dose of up to 250 mSv for voluntary emergency life-saving activities [5]. These limits will be used to show the amount of time a healthcare provider can treat both internally and externally contaminated patients before receiving the predetermined doses.

4.1 Externally Contaminated Patients

Externally contaminated patients are generally believed to pose a higher threat to the healthcare provider than internally contaminated patients because the bodies of the internally contaminated patients offer some shielding to the healthcare provider. In addition to the distance between the healthcare provider and the time the healthcare provider spends with the patient, the dose to the healthcare provider due to an externally contaminated patient is principally dependent

on three factors: the isotope, the skin surface area of the patient, and the body type of the healthcare provider.

Energy deposition tallies were taken over each of the internal organs in the healthcare provider in order to determine the effective dose to the healthcare provider. The contribution to the effective dose rates to each organ are shown for each healthcare provider, each patient, and each isotope in Appendix I. There are distinct patterns for which organ receives the highest and lowest contributions to the effective dose. For the reference male, adipose male and reference female the highest contribution to the effective dose is to either the stomach or the colon regardless of the body type of the patient. The reference phantoms have the lowest percentage of body fat and the organs in the abdominal area are closest in proximity to the patient allowing more radiation to reach the internal organs such as the colon and the stomach. For the male healthcare providers the operating table provides shielding for the gonads, greatly reducing the amount of radiation reaching this organ. The closest radiosensitive organs to the patient for the adipose male healthcare provider are also the colon and the stomach. For the adipose female phantoms, the organs that receive the highest contribution to the effective dose rate are dependent on the isotope in question. Due to the penetrating ability of ^{60}Co , ^{192}Ir , ^{137}Cs and ^{131}I , either the stomach or the colon receives the highest contribution to the effective dose. For the low energy gamma emitted by ^{241}Am , the breasts receive the highest contribution to the effective dose. The breasts on the adipose females are significantly larger than those on the reference female and the internal organs of the adipose females are shielded by the additional tissue, accounting for the difference between the reference female and the adipose female healthcare providers.

The lowest contribution to the effective dose exhibits a pattern that is completely independent of both the body type of the patient and the healthcare provider. For ^{60}Co , ^{192}Ir , ^{137}Cs and ^{131}I , the skin produces the lowest contribution to the effective dose due to the ability of the more penetrating radiation easily reaches the internal organs and the skin's small tissue weighting factor. For ^{241}Am , the radiation does not easily penetrate the body. Due to the low tissue weighting factor and the small mass of the esophagus, it receives the lowest contribution to the effective dose for the less penetrating radiation.

The overall effective dose rate as a function of body type follows a general pattern as well. A three dimensional graph of the effective dose rate as a function of the body type of the healthcare provider and the body type of the patient for 37 GBq/m^2 external contamination with ^{137}Cs is shown in Figure 4.1. The reference female and reference male healthcare providers receive the two highest effective dose rates. The adipose tissue of the anthropomorphic phantoms cause the postmenopausal adipose female, the adipose female and the adipose male healthcare providers to receive lower effective dose rates. The adipose females receive higher dose rates than the adipose male due to the sensitivity of the breast tissue to radiation. The body type of the healthcare provider has a profound impact on the effective dose rate to the healthcare provider.

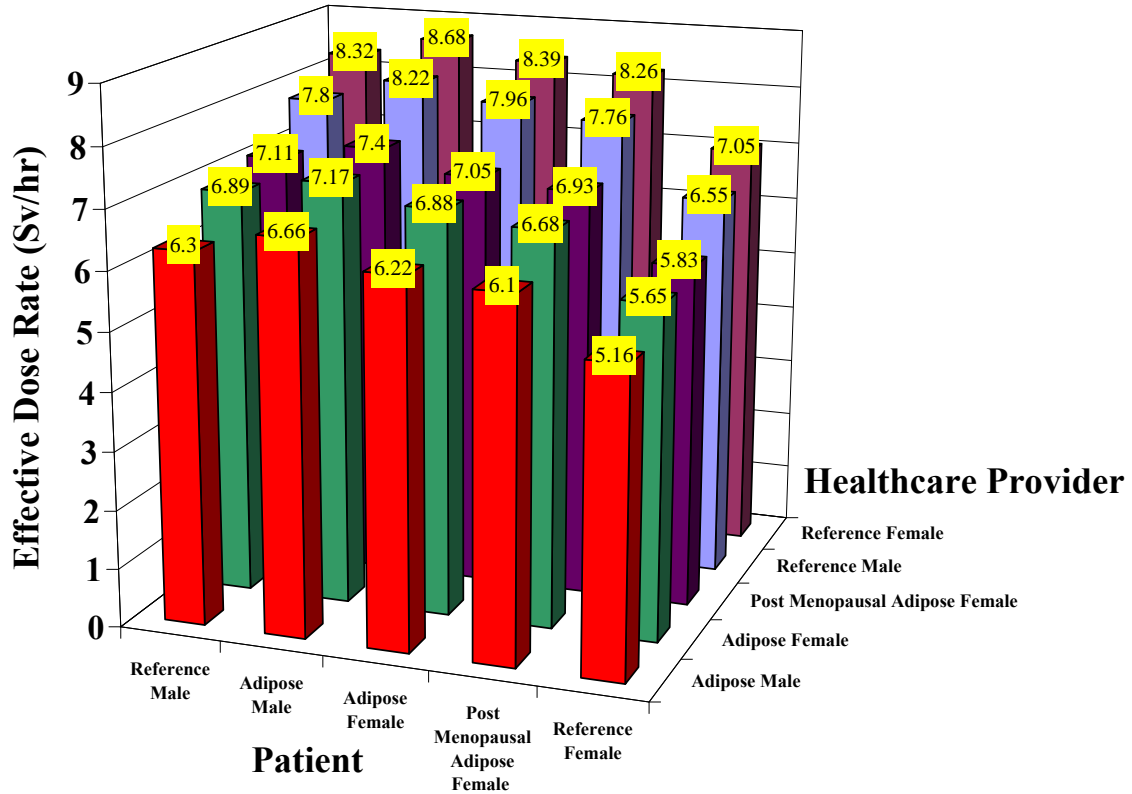

Figure 4.1 Healthcare Provider Effective Dose Due to 37 GBq/m^2 of External Contamination of ^{137}Cs on the Patient

The effect of the body type of the patient is somewhat more complicated than the effect of the body type of the healthcare provider. The adipose male, which has the largest surface area, and the reference female, which has the smallest surface area, cause the highest and lowest effective dose rates to the healthcare providers, respectively. The other patients produced similar effective dose rates to the healthcare provider. The amount of contamination present on the patient, which is determined by the surface area of the patient, is the main factor in determining the effective dose rate to the healthcare provider based on the body type of the patient.

The isotope the patient is contaminated with plays a major role in determining the effective dose rate to the healthcare provider. The effective dose rates for different healthcare

providers, the average effective dose rate and the standard deviation for the different isotopes at a contamination level of 37 GBq/m² is shown in Table 4.1. The highest effective dose rates are due to ⁶⁰Co because it emits two high energy gamma rays. The lowest effective dose rate is due to ²⁴¹Am because it emits a low energy gamma ray. The effective dose rates due to the other isotopes are dependent on a combination on gamma-ray energy and emission intensity.

Table 4.1 Effective Dose for Isotopes for 37 GBq/m² External Contamination (mSv/hr)

Healthcare Provider	⁶⁰Co	¹⁹²Ir	²⁴¹Am	¹³⁷Cs	¹³¹I
Reference Male	30.2 ± 2.69	12.8 ± 1.02	0.4 ± 0.03	7.7 ± 0.65	4.7 ± 0.39
Reference Female	31.6 ± 2.58	13.6 ± 1.06	0.4 ± 0.03	8.1 ± 0.63	5.0 ± 0.39
Adipose Male	25.2 ± 2.37	9.6 ± 0.91	0.4 ± 0.03	6.1 ± 0.56	3.6 ± 0.33
Adipose Female	27.1 ± 2.50	10.7 ± 0.91	0.3 ± 0.02	6.7 ± 0.59	4.0 ± 0.34
Postmenopausal Adipose Female	28.6 ± 2.64	10.9 ± 0.99	0.3 ± 0.02	6.9 ± 0.60	4.0 ± 0.32
Average	28.5	11.5	0.3	7.1	4.2
Standard Deviation	3.2	1.8	0.1	0.9	0.6

4.1.1 Beta Dose to Healthcare Provider

The beta dose to the healthcare provider from an externally contaminated patient was assumed to be only the skin dose to the hands of the healthcare provider. The surface area of the hand is approximately 1% of the surface area of the individual's body [19]. The dose received by the hands is of concern because it may result in reddening of the skin or skin burn. The dose required to produce reddening of the skin is 3 Gy [3]. The dose to the hands was computed by

assuming full energy deposition for the beta particles in the same manner as the beta dose to the patient was determined. The absorbed dose to the hands of the healthcare provider for beta particles is shown in Table 4.2 for each of the isotopes. The time required for the healthcare provider to receive a dose of 3 Gy to the hands is shown in Table 4.3. The total dose to the healthcare provider including the dose to both hands from beta particles in mSv/hr for a patient contaminated with 37 GBq/m² of external contamination and in (mSv/hr)/Bq are shown in Tables 4.4 and 4.5, respectively. The time it takes the healthcare provider to receive 250mSv is shown in Table 4.6.

Table 4.2 Beta Absorbed Dose to Hands of Healthcare Provider for 37GBq/m² Externally Contaminated Patient (mGy/hr)

Healthcare Provider	⁶⁰Co	¹⁹²Ir	¹³⁷Cs	¹³¹I
Reference Male	142.1	253.1	276.3	268.4
Reference Female	129.1	229.9	251.0	243.8
Adipose Male	199.0	354.4	386.8	375.8
Adipose Female	159.0	283.1	309.0	300.2
Postmenopausal Adipose Female	169.6	302.1	329.7	320.3
Average	159.8	284.5	310.5	301.7
Standard Deviation	26.9	47.8	52.2	50.7

Table 4.3 Time in Hours Before the Healthcare Provider's Hands Receives a 3 Gy Dose for 37GBq/m² Externally Contaminated Patient

Healthcare Provider	⁶⁰Co	¹⁹²Ir	²⁴¹Am	¹³⁷Cs	¹³¹I
Reference Male	19.8	11.7	7.92E+03	10.7	11.1
Reference Female	20.7	12.7	9.75E+03	11.8	12.2
Adipose Male	14.3	8.4	6.32E+03	7.7	7.9
Adipose Female	16.9	10.3	3.95E+03	9.6	9.9
Postmenopausal Adipose Female	16.1	9.7	4.31E+03	9.0	9.3

Table 4.4 Total Effective Dose to Healthcare Provider for 37GBq/m² Externally Contaminated Patient (mSv/hr)

Healthcare Provider	⁶⁰ Co	¹⁹² Ir	²⁴¹ Am	¹³⁷ Cs	¹³¹ I
Reference Male	31.6	15.3	0.4	10.5	7.4
Reference Female	32.9	15.9	0.4	10.6	7.4
Adipose Male	27.2	13.1	0.4	10.0	7.4
Adipose Female	28.7	13.5	0.3	9.8	7.0
Postmenopausal Adipose Female	30.3	13.9	0.3	10.2	7.2
Average	30.1	14.4	0.4	10.2	7.3
Standard Deviation	2.3	1.2	0.1	0.3	0.2

Table 4.5 Total Effective Dose to Healthcare Provider Due to Externally Contaminated Patient (mSv/hr)/Bq

Healthcare Provider	⁶⁰ Co	¹⁹² Ir	²⁴¹ Am	¹³⁷ Cs	¹³¹ I
Reference Male	4.74795E-10	2.3E-10	6E-12	1.6E-10	1.1E-10
Reference Female	4.9386E-10	2.4E-10	6E-12	1.6E-10	1.1E-10
Adipose Male	4.08256E-10	2E-10	6E-12	1.5E-10	1.1E-10
Adipose Female	4.30774E-10	2E-10	4.5E-12	1.5E-10	1.1E-10
Postmenopausal Adipose Female	4.54897E-10	2.1E-10	4.5E-12	1.5E-10	1.1E-10

Table 4.6 Time in Hours Before Healthcare Provider Receives a 250mSv Dose for 37GBq/m² Externally Contaminated Patient

Healthcare Provider	⁶⁰ Co	¹⁹² Ir	²⁴¹ Am	¹³⁷ Cs	¹³¹ I
Reference Male	7.9	16.3	625.0	23.9	33.9
Reference Female	7.6	15.7	625.0	23.6	33.6
Adipose Male	9.2	19.0	625.0	25.1	34.0
Adipose Female	8.7	18.5	833.3	25.5	35.7
Postmenopausal Adipose Female	8.3	18.0	833.3	24.5	34.7
Average	8.3	17.5	708.3	24.5	34.4
Standard Deviation	0.6	1.4	114.1	0.8	0.9

4.2 Internally Contaminated Patients

The dose received by the healthcare provider is much more complicated to predict from an internally contaminated patient than an externally contaminated patient. The location of the radioactive material in the body of the patient is dependent on isotope and time, in addition to the body type of the patient, the body type of the healthcare provider and the type and energy of the emitted radiation. This means that the patterns in the dose rate as a function of body type are much more strongly dependent on the isotope the patient has been exposed to. The distribution of the different isotopes six hours after inhalation are given in Table 4.7, and the effects of the isotope on the effective dose rate received by the healthcare provider from different patients are shown in Figures 4.2 through 4.9.

Table 4.7 Inhalation Class and Fraction of Isotope in Each Compartment Six Hours after Inhalation

	⁶⁰ C (slow)	⁶⁰ C (moderate)	²⁴¹ Am (moderate)	¹⁹² Ir (slow)	¹⁹² Ir (moderate)
Lung	2.72E-01	2.40E-01	2.42E-01	3.12E-01	2.97E-01
Stomach	1.85E-03	1.51E-03	1.71E-03	1.20E-01	1.14E-01
Small Intestine	8.65E-02	5.31E-02	6.32E-02	4.79E-02	4.61E-02
Blood	3.41E-03	2.87E-02	2.94E-04	2.42E-04	2.16E-02
Ascending Colon	6.46E-02	4.16E-02	4.30E-02	6.56E-04	6.60E-04
Transverse Colon	8.61E-02	5.54E-02	5.74E-02	8.74E-04	8.79E-04
Descending Colon	1.89E-02	1.23E-02	1.18E-02	6.56E-04	6.60E-04
Sigmoid Colon	1.47E-02	9.56E-03	9.21E-03	5.10E-04	5.13E-04
Other	2.95E-04	4.01E-03	7.63E-03	5.60E-06	5.34E-04
Liver	3.28E-05	4.45E-04	9.04E-03	2.07E-06	1.98E-04
Urinary Bladder	4.82E-05	1.32E-03	1.53E-04	9.35E-07	8.90E-05
Bone Surface	----	----	5.44E-03	----	----
Kidneys	----	----	4.47E-04	4.15E-07	3.96E-05
Testes	----	----	6.39E-06	----	----
Ovaries	----	----	2.03E-06	----	----
Bone Volume	----	----	1.53E-07	----	----
Bone Marrow	----	----	2.61E-07	----	----
Body Tissue	----	----	----	----	----
Spleen	----	----	----	2.07E-07	1.98E-05
Thyroid	----	----	----	----	----

Table 4.7 (Continued)

	¹⁹² Ir (fast)	¹³⁷ Cs (fast)	¹³¹ I (fast)
Lung	1.63E-01	1.16E-01	1.14E-01
Stomach	6.18E-02	2.85E-04	2.79E-04
Small Intestine	3.03E-02	1.19E-05	1.17E-05
Blood	2.15E-01	1.78E-01	1.74E-01
Ascending Colon	6.96E-04	3.43E-04	2.77E-04
Transverse Colon	9.28E-04	4.57E-04	3.70E-04
Descending Colon	6.96E-04	1.56E-04	1.42E-04
Sigmoid Colon	5.41E-04	1.22E-04	1.10E-04
Other	5.34E-03	----	5.19E-05
Liver	1.98E-03	----	----
Urinary Bladder	8.89E-04	2.91E-04	3.18E-02
Bone Surface	----	----	----
Kidneys	3.95E-04	----	----
Testes	----	----	----
Ovaries	----	----	----
Bone Volume	----	----	----
Bone Marrow	----	----	----
Body Tissue	----	1.57E-01	----
Spleen	1.98E-04	----	----
Thyroid	----	----	4.63E-02

The distribution of the isotope in the body affects the dose to the healthcare provider. For ⁶⁰Co and ²⁴¹Am, the radioisotopes are concentrated in the lungs and large intestines after six hours as shown in Table 4.7. The affects of the body type of the healthcare provider and the patient on the effective dose rate are shown in Figures 4.2 through 4.4. The adipose patients provide more shielding for the healthcare provider. The postmenopausal adipose female and the adipose male patients result in the lowest dose to the healthcare provider due to the large amount of interstitial fat in the abdomen area. The adipose female produces a marginally higher effective dose rate to the healthcare provider. The reference female and reference male patients

result in the highest effective dose rates in the healthcare provider. The slow uptake class for ^{60}Co produced a higher effective dose to the healthcare provider than the moderate uptake class due to the retention of the isotope in the patient's body.

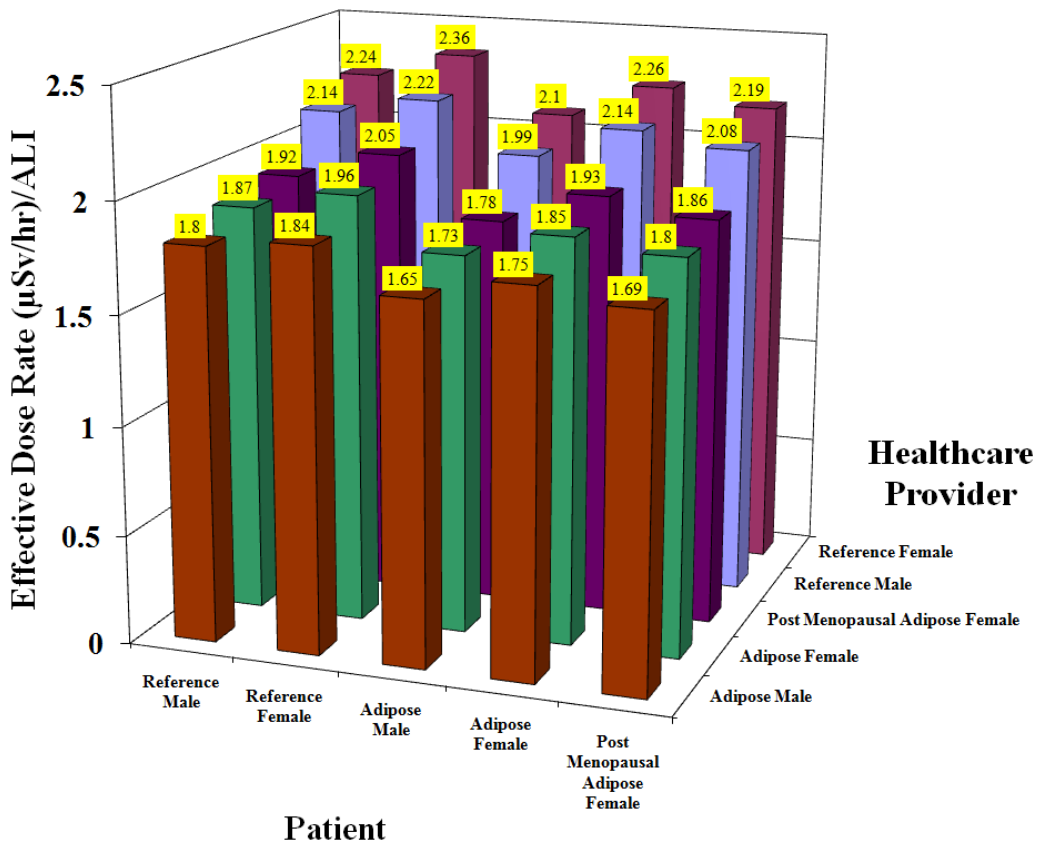

Figure 4.2 Effective Dose Rate to Healthcare Provider Due to ^{60}Co (slow)

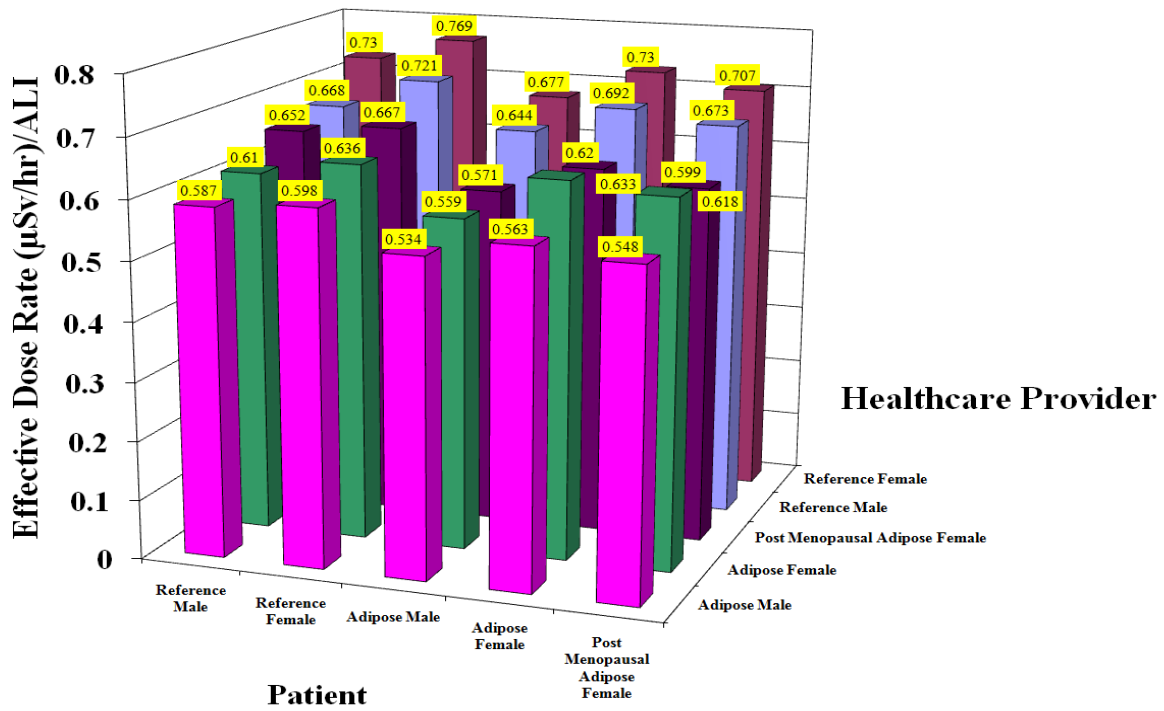

Figure 4.3 Effective Dose Rate to Healthcare Provider Due to ⁶⁰Co (moderate)

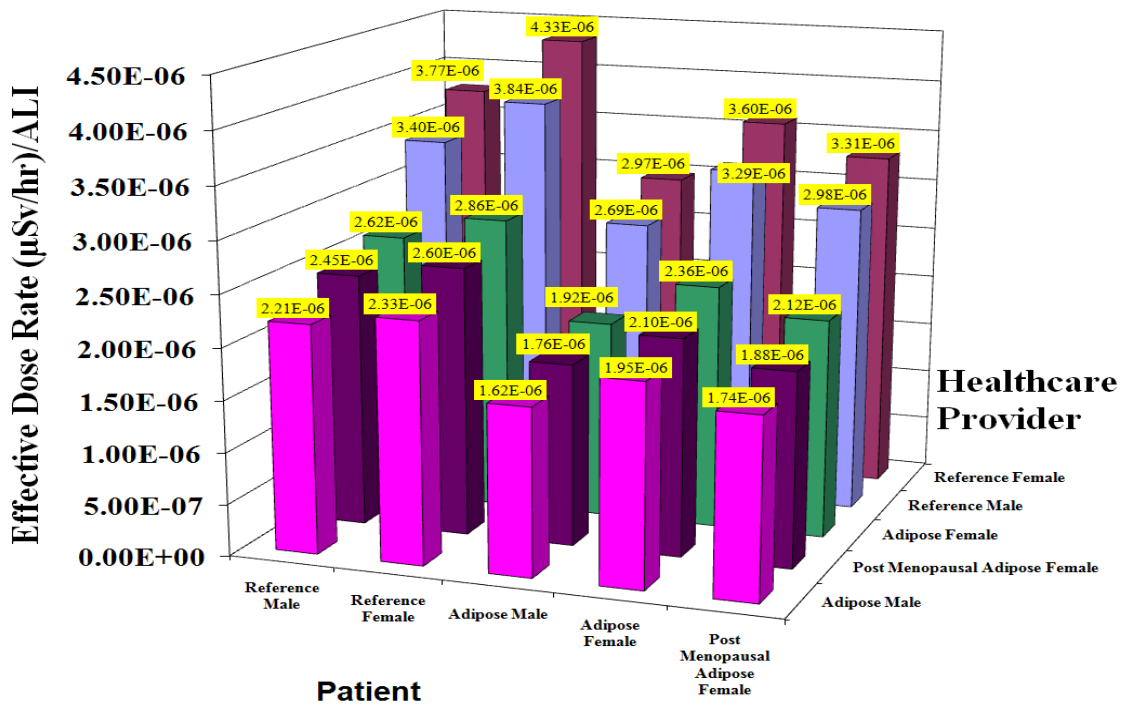

Figure 4.4 Effective Dose Rate to Healthcare Provider Due to ²⁴¹Am

^{192}Ir distributes itself much differently in the body than ^{60}Co . As shown in Table 4.7, ^{192}Ir is dispersed in the lungs, liver, blood, large intestines, and small intestines after six hours. The uptake class for ^{192}Ir affected the dose to the healthcare provider due to the retention rate of the isotope in the body as shown in Figures 4.5 through 4.7. The highest effective dose to the healthcare provider due to ^{192}Ir is for the slow uptake class. The reference female and reference male patients cause the healthcare provider to receive the highest effective doses due to the lack of shielding in the abdominal area. The additional adipose tissue in the abdominal area of the adipose patients provides some shielding for the healthcare provider depending on the thickness of the adipose layer. The third highest effective dose to the healthcare provider is caused by the adipose female since she has the smallest adipose layer in the abdominal region. The lowest effective doses are produced by the postmenopausal adipose female and the adipose male due to the large amount of adipose tissue in the abdominal region.

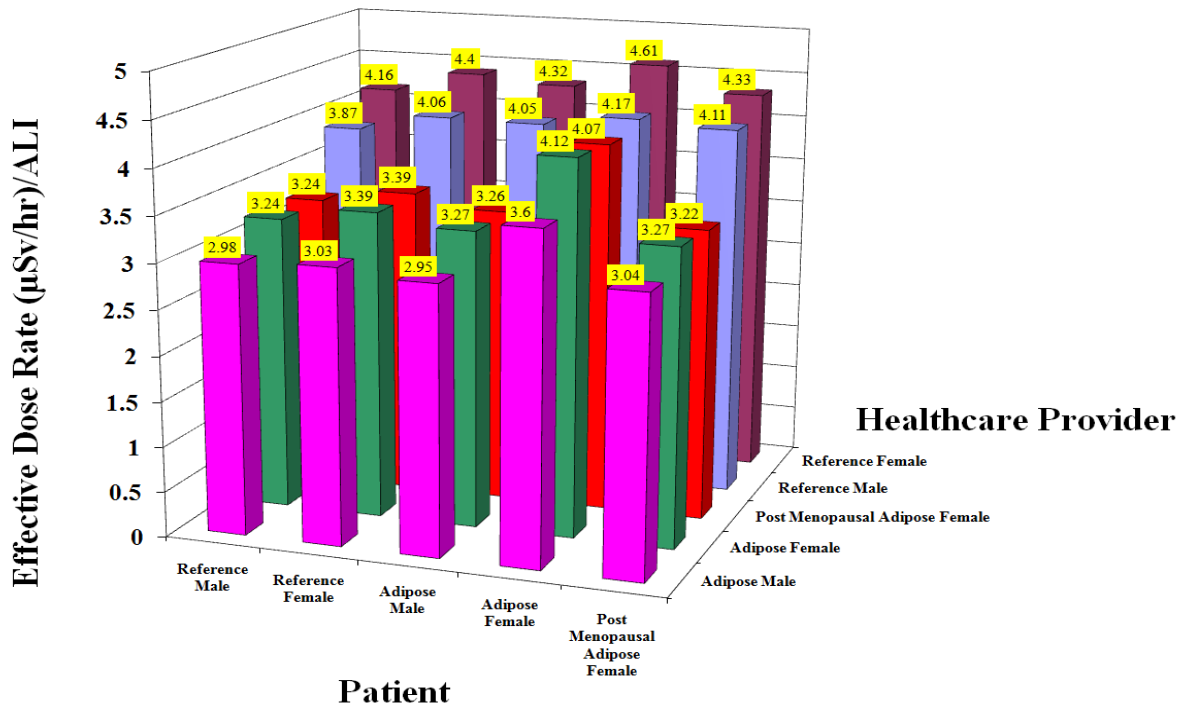

Figure 4.5 Effective Dose Rate to Healthcare Provider Due to ^{192}Ir (slow)

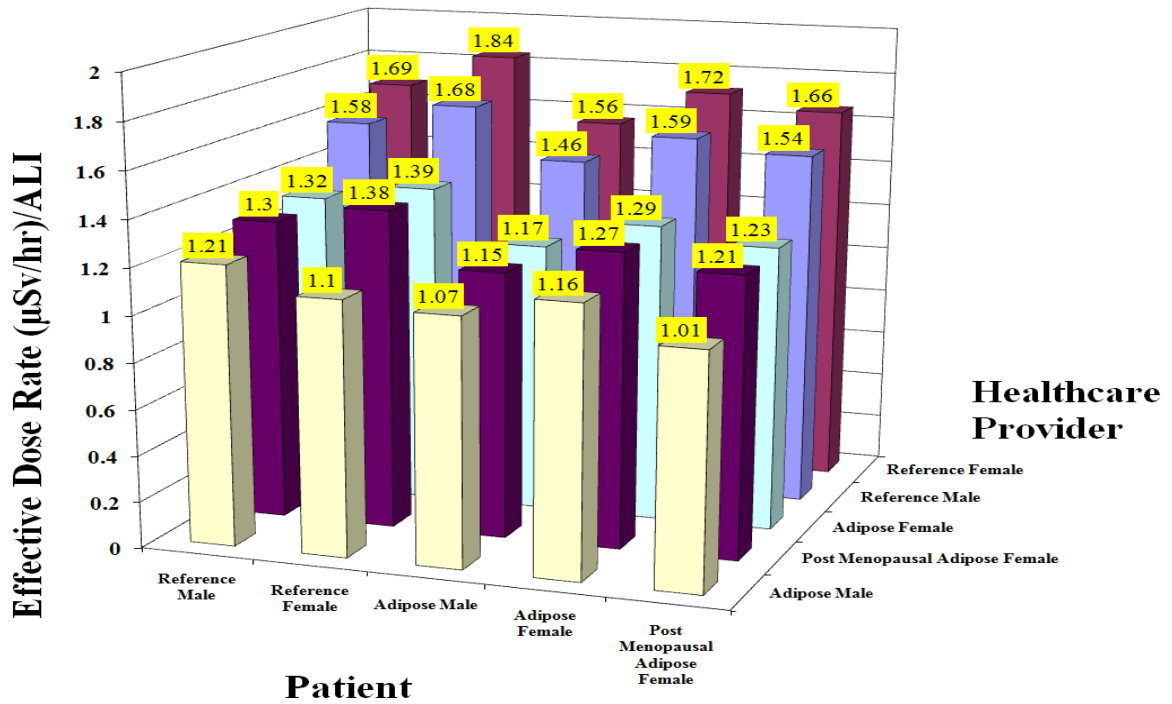

Figure 4.6 Effective Dose Rate to Healthcare Provider Due to ^{192}Ir (moderate)

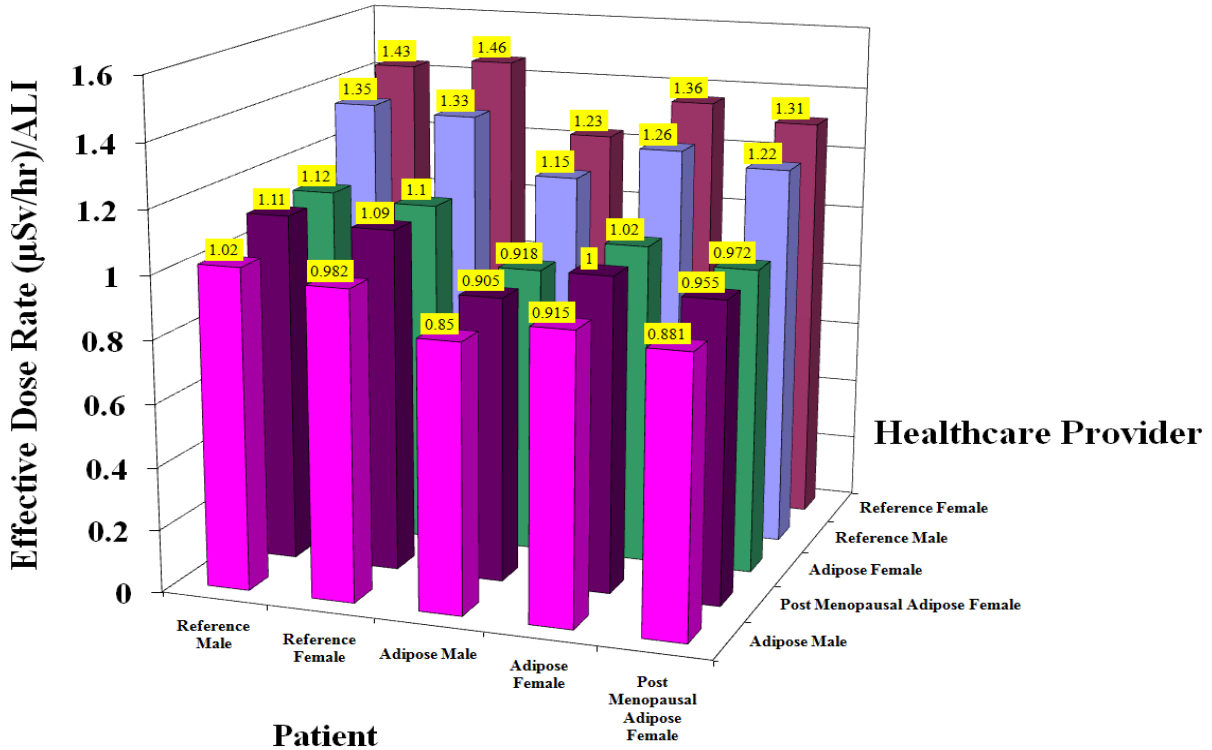

Figure 4.7 Effective Dose Rate to Healthcare Provider Due to ^{192}Ir (fast)

^{137}Cs tends to distribute itself uniformly throughout the body tissue and blood after six hours as shown in Table 4.7. The dose to the healthcare provider as a function of the patient's body type for ^{137}Cs is depicted in Figure 4.8. The adipose male and the postmenopausal adipose female patients result in the highest dose to the healthcare provider because they have the largest amount of body tissue in close proximity to the healthcare provider. The postmenopausal adipose female patient produces a slightly higher effective dose rate than the adipose male due to the combination of the adipose tissue on the abdomen and the breast tissue. The adipose female results in the third highest effective dose rate due to the increase in body tissue over the reference male and reference female. The reference male and reference female result in the lowest effective dose rates to the healthcare provider.

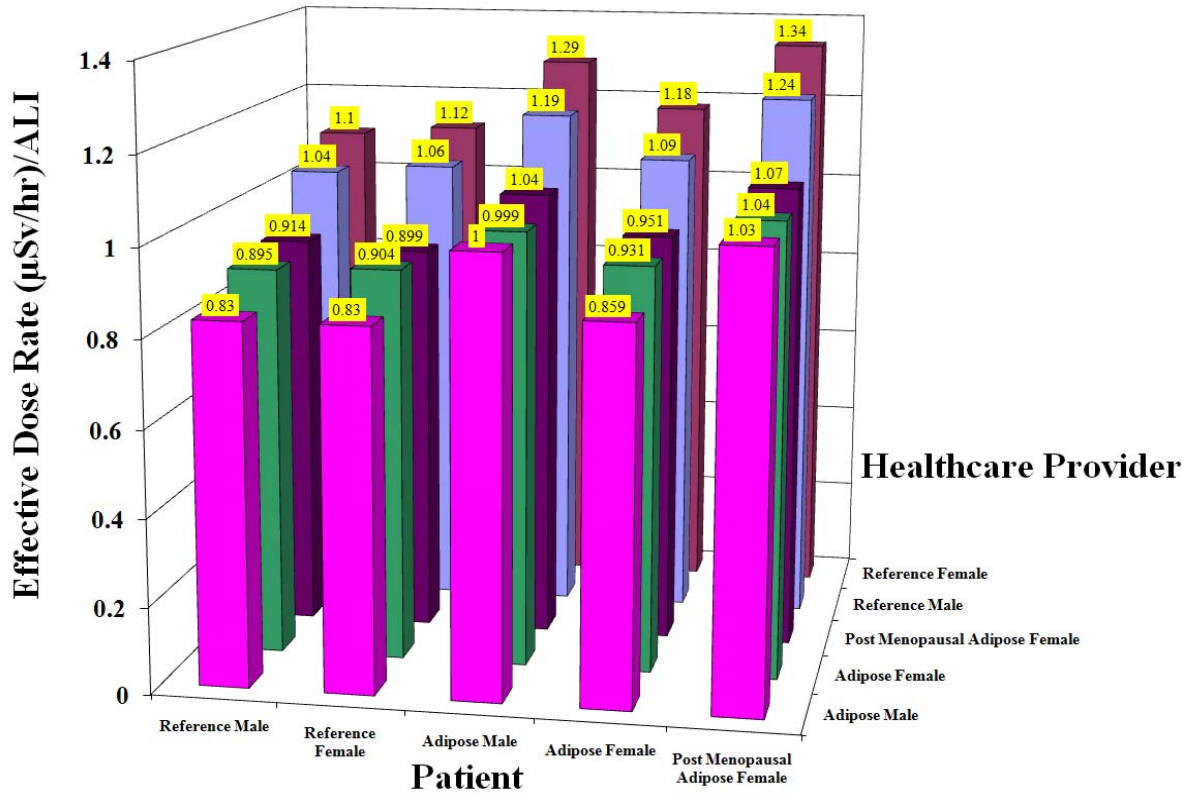

Figure 4.8 Effective Dose Rate to Healthcare Provider Due to ^{137}Cs

^{131}I is mainly distributed in the lungs, blood and thyroid six hours after inhalation as shown in Table 4.7. The reference male and reference female patients result in the highest effective dose to the healthcare provider due to the reduction in shielding due to the absence of adipose tissue. The adipose female patient produces the third highest effective dose rate in the healthcare provider for a combination of reasons. Although the adipose female does not have as much adipose tissue as the adipose male and the postmenopausal adipose female, the additional tissue present in the abdominal area and the breasts reduces the effective dose to the healthcare provider. The adipose male and the postmenopausal adipose female phantoms have the same amount of blood dispersed in the body as the other phantoms, thus diluting the effects of the radioisotope present in the blood. The additional breast tissue aids in shielding the heart and

lungs from the healthcare provider. This combination causes the adipose male and the postmenopausal adipose female to produce the lowest effective dose rates in the healthcare provider. These trends are shown in Figure 4.9.

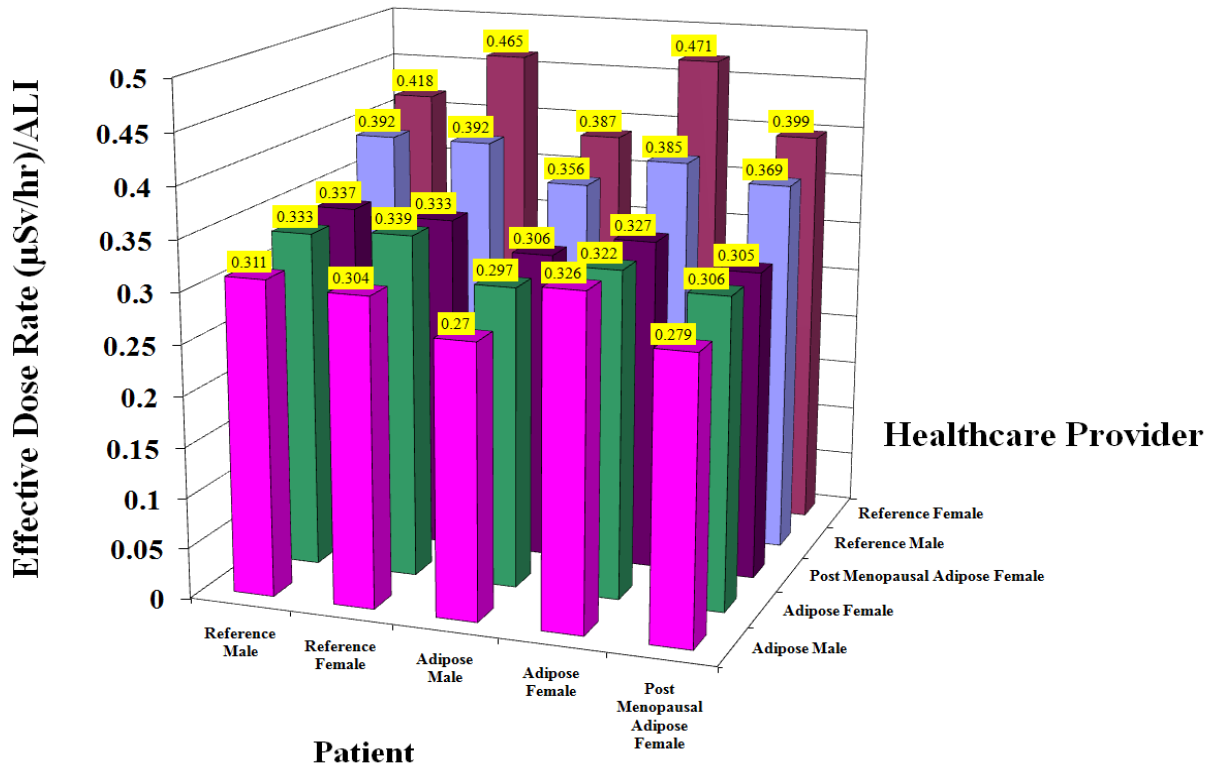

Figure 4.9 Effective Dose Rate to Healthcare Provider Due to ^{131}I

The trend of the effect of the body type of the healthcare provider on the effective dose rate is consistent with that found for the externally contaminated patients and is constant over all isotopes. The reference female healthcare provider receives the largest dose due to the exposure of the breast tissue and the lack of adipose tissue to shield the radiosensitive internal organs. The

reference male healthcare provider receives the second highest dose due to the absence of adipose tissue to shield his internal organs. The operating table also provided shielding to the gonads for the reference male. The postmenopausal adipose female and the adipose female receive the third and fourth highest effective dose rates due to the exposure of the breast tissue and the addition of adipose tissue to shield the internal organs. The adipose male receives the lowest effective dose rate due to the additional shielding provided by the adipose tissue and the operating table for his gonads.

The organ that received the highest and lowest contribution to the effective dose largely seemed to be independent of the body type of both the healthcare provider and the patient. For the reference male, reference female and the adipose male healthcare providers, the highest contribution to the effective dose was delivered to either the stomach or the colon for all isotopes. This is due to the high tissue weighting factor for and their organs there proximity to the patient. For the adipose female and postmenopausal adipose female healthcare providers, the highest contribution to the effective dose was to the colon or stomach for all isotopes except ^{241}Am . For ^{241}Am , the highest contribution to the effective dose was contributed by the breasts. This is due to the low energy gamma ray emitted by ^{241}Am , the increased breast size of the adipose female healthcare provider, and the additional shielding provided by the adipose tissue. The minimum contribution to the effective dose was delivered to the skin for all body types of both the healthcare provider and the patient and the isotope of contamination. The contribution to the effective dose rate to each organ and the absorbed dose for each organ for the different healthcare providers irradiated by internally contaminated patients are shown in Appendix J and M, respectively.

The isotope and uptake class for inhalation greatly affect the dose to the healthcare provider. The effective doses for the different isotopes per ALI inhaled by the patient are shown in Table 4.8. The highest effective dose rate is ^{192}Ir with a slow inhalation class. This is due to the concentration of ^{192}Ir in the organs located in the abdomen region and the higher retention rate for the slow intake class. The healthcare provider was placed 20-cm from the abdomen of the patient greatly increasing the dose from isotopes concentrated in this region. The lowest effective dose rate is due to ^{241}Am because it emits a low energy gamma ray. The effective dose rates due to the other isotopes are dependent on a combination on gamma ray energy, intensity and distribution in the body of the patient.

Table 4.8 Effective Dose to Healthcare Providers from Patients with Internal Contamination
($\mu\text{Sv/hr}$)/ALI

Healthcare Provider	^{60}Co (m)	^{60}Co (s)	^{192}Ir (f)	^{192}Ir (m)	^{192}Ir (s)	^{241}Am	^{137}Cs	^{131}I
Reference Male	0.7 ± 0.03	2.1 ± 0.09	1.3 ± 0.08	1.6 ± 0.08	4.1 ± 0.11	3.24E-06 ± 4.35E-07	1.12 ± 0.09	0.38 ± 0.02
Reference Female	0.7 ± 0.03	2.2 ± 0.10	1.4 ± 0.09	1.7 ± 0.10	4.4 ± 0.16	3.60E-06 ± 5.11E-07	1.21 ± 0.11	0.41 ± 0.01
Adipose Male	0.6 ± 0.03	1.7 ± 0.08	0.9 ± 0.07	1.1 ± 0.08	3.1 ± 0.27	1.97E-06 ± 3.01E-07	0.91 ± 0.10	0.29 ± 0.02
Adipose Female	0.6 ± 0.03	1.8 ± 0.09	1.0 ± 0.09	1.3 ± 0.08	3.5 ± 0.37	2.38E-06 ± 3.77E-07	0.95 ± 0.06	0.32 ± 0.02
Postmenopausal Adipose Female	0.6 ± 0.04	1.9 ± 0.10	1.0 ± 0.09	1.3 ± 0.09	3.4 ± 0.36	2.16E-06 ± 3.60E-07	0.97 ± 0.08	0.32 ± 0.02
Average	0.6	2.0	1.1	1.4	3.7	2.67E-06	1.03	0.35
Standard Deviation	0.1	0.2	0.2	0.2	0.5	7.46E-07	0.14	0.05

4.3 Comparison of Dose to Healthcare Provider Due to Internally and Externally Contaminated Patients

Comparisons between the dose to healthcare provider due to a patient with internal contamination for the slowest uptake class considered and a patient with 37 GBq/m² for ⁶⁰Co, ¹⁹²Ir, ²⁴¹Am, ¹³⁷Cs, and ¹³¹I are shown in Tables 4.9.

Table 4.9 Dose to Healthcare Provider from patient for 1 ALI Internal Contamination and 37 GBq/m² External Contamination for ⁶⁰Co in mSv/hr

Type of Contamination	⁶⁰ Co (s)	¹⁹² Ir (s)	²⁴¹ Am	¹³⁷ Cs	¹³¹ I
Internal (μSv/hr)	2.0	3.7	2.67E-06	1.03	0.35
External (mSv/hr)	30.1	14.4	0.4	10.2	7.3

The general trends of the dose to the healthcare provider due to contaminated patients are generally the same for both the internally and externally contaminated patients. The distribution of ¹⁹²Ir and ⁶⁰Co in the body for the internally contaminated patient results in the ¹⁹²Ir causing a higher effective dose rate in the healthcare provider. The internally contaminated patients result in a significantly smaller dose to the healthcare provider especially for ²⁴¹Am.

The time the healthcare provider can operate on the contaminated patient before reaching a predetermined limit is determined by whether the contamination is internal or external and the isotope of contamination. For internally contaminated patients, the dose rate received by the healthcare provider is continuously changing with time, so it is not possible to determine the amount of time it takes the healthcare provider to receive a specific dose without further analysis. The amount of time in hours the healthcare provider can safely operate on the externally

contaminated patients before receiving doses of 50 mSv and 250 mSv are depicted in Tables 4.10.

Table 4.10 Time (Hours) It Takes for Healthcare Provider to Receive 50 mSv and 250 mSv Dose from 37 GBq/m² Externally Contaminated Patient

Dose to Healthcare Provider	⁶⁰Co (s)	¹⁹²Ir (s)	²⁴¹Am	¹³⁷Cs	¹³¹I
50 mSv	1.7	3.5	125.0	4.9	6.8
250 mSv	8.3	17.5	708.3	24.5	34.4

A comparison of the findings from this work to that of Bridges [1] are shown in Tables 4.11 and 4.12 for the dose to the patient and the dose to the healthcare provider from an externally contaminated patient, respectively. These findings are on the same order of magnitude as the findings determined by Bridges. The discrepancies have to do with the difference in height of the reference male phantom and the difference in the breast structure of the male. Bridges employed the BodyBuilder program to create the reference male phantom MCNP model which resulted in a slightly taller phantom. This would lead to a larger surface area for the phantom causing a larger source to be concentrated on the patient. Bridges used a modified version of the reference female phantom with larger breasts, which increased the surface area of the phantom resulting in larger overall source strength of the patient. The same adipose male phantom was used in both studies which explains the small difference in values for the dose to the patient. For the effective dose to the healthcare provider, a different tally was employed in this study which tallies the electrons and photons at the same time. Bridges' results were obtained using a separate tally for the secondary electrons and the photons. This may

account for the difference in the effective dose to the healthcare provider. The results from the study performed by Smith et al. were obtained using point kernel calculations and are in good agreement with the results obtained in this study.

Table 4.11 Comparison of Bridges' Study and the Present Work for Dose to the Patient with 37 GBq/m² External Contamination (mSv/hr) [1]

Patient	⁶⁰ Co	¹⁹² Ir	²⁴¹ Am	¹³⁷ Cs	¹³¹ I
Reference Male					
This Study	204.1	88.2	2.61	62.4	41.6
Bridges' Study	270	90.9	2.8	66.9	41.6
Reference Female					
This Study	174.1	77.0	2.32	55.0	24.0
Bridges' Study	233	77.9	2.44	57.4	35.7
Adipose Male					
This Study	206.1	90.8	2.94	63.1	29
Bridges' Study	219	74	2.32	48	30.5

Table 4.12 Comparison of Bridges' Study, Smith et al., and the Present Work for Dose to the Healthcare Provider Due to Patient with 37 GBq/m² External Contamination (mSv/hr) [1] [8]

Healthcare Provider / Patient	⁶⁰ Co	¹⁹² Ir	²⁴¹ Am	¹³⁷ Cs	¹³¹ I
Smith et al. Results (mSv/hr)	39	15	0.66	10	--
Reference Male / Reference Male					
This Study (mSv/hr)	32.1	15.7	0.4	10.6	7.5
Bridges' Study (mSv/hr)	41.9	15.3	0.49	10.7	6.99
Reference Female / Reference Female					
This Study (mSv/hr)	28.5	14.1	0.4	9.6	6.8
Bridges' Study (mSv/hr)	37	13.4	0.426	9.44	6.08
Adipose Male / Adipose Male					
This Study (mSv/hr)	29.8	13.9	0.3	10.5	7.6
Bridges' Study (mSv/hr)	28.2	9.32	0.275	7.04	5.03
Reference Male / Adipose Male					
This Study (mSv/hr)	34.1	16.0	0.4	11.0	7.7
Bridges' Study (mSv/hr)	44.2	16.2	0.529	11.4	7.42

CHAPTER 5

DOSE TO PATIENT

The effective dose rate to the patient due to external contamination is a concern. Two major factors affect the dose received by the patient: the amount of fat on the patient and the surface area of the patient's skin. More body fat provides more shielding for the radiosensitive internal organs, thus reducing the dose. On the other hand, patients with large skin surface areas have a higher level of total activity on their bodies than the patients with smaller skin surface areas because a uniform distribution was assumed.

5.1 Reference Male

The reference male, having a skin surface area of 1.8 m^2 and a BMI of 20, contains a total of 66.6 GBq of external contamination assuming a uniform contamination level of 37 GBq/m^2 . The reference male does not contain a significant amount of body fat to shield his radiosensitive internal organs. The percentage of the effective dose by organ is shown in Figure 5.1. Due to the higher energy photons emitted by ^{60}Co , ^{192}Ir , ^{137}Cs , and ^{131}I , the internal organs are not shielded very well. The colon wall yields the largest contribution to effective dose due to its higher weighting factor. The skin has the lowest contribution to effective dose due to its low weighting factor. ^{241}Am follows a somewhat different pattern than the isotopes discussed above. ^{241}Am emits a low energy gamma ray of 59.5 keV. The penetrating power of this gamma ray is much smaller than that of the higher energy gamma rays emitted by the other isotopes. Due to

the weighting factor, the bone dose is the largest contributor to the effective dose. For ^{241}Am , the esophagus received both the lowest absorbed dose and the lowest contributor to the effective dose. The effective dose contribution and absorbed dose per organ for each isotope for a contamination level of 37 GBq/m^2 for the reference male phantom are shown in Appendix I and L, respectively.

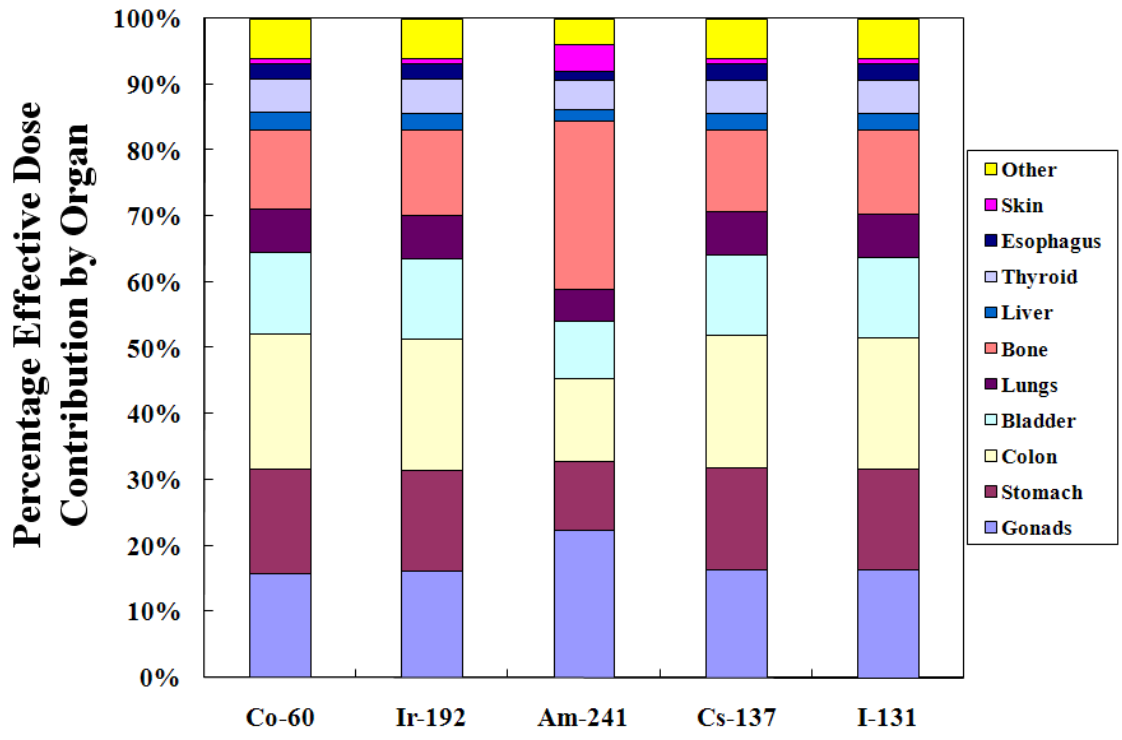

Figure 5.1 The Percentage of the Effective Dose Contributions by Organ for the Reference Male

5.2 Reference Female

The reference female, with a surface area of 1.635 m² and a BMI of 23, contains 60.5 GBq of external contamination for a uniform surface contamination of 37 GBq/m². Similarly to the reference male, the reference female does not have a significant amount of body fat to shield her internal organs. The percentage of the total effective dose contributed by each organ is dependent on the isotope of contamination. For ⁶⁰Co, ¹⁹²Ir, ¹³⁷Cs and ¹³¹I, the penetrating ability of the high-energy gamma rays allows a significant amount of the radiation to reach the internal organs is shown in Figure 5.2. The effective dose contribution and absorbed dose per organ for each isotope for a contamination level of 37 GBq/m² for the reference female phantom are shown in Appendix I and L, respectively..

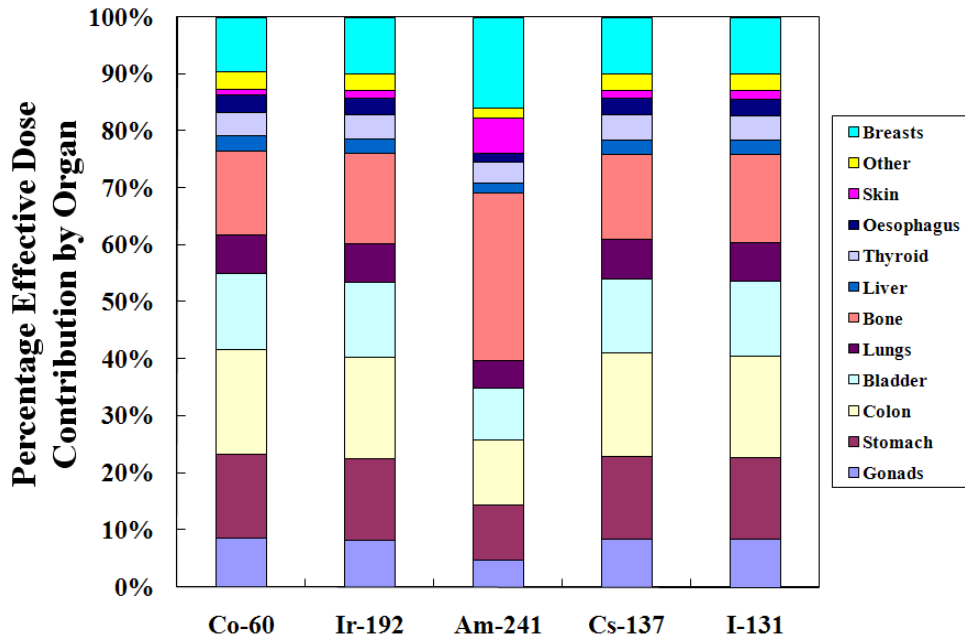

Figure 5.2 The Percentage of the Effective Dose Contributions by Organ for the Reference Female

5.3 Adipose Male

The adipose male has a BMI of 30 and contains 22 kg of interstitial adipose tissue, which provides some shielding for his internal organs. The surface area of his body is 2.52 m², which is significantly large than the reference male and results in 93.24 GBq of total external contamination for the 37 GBq/m² uniform surface contamination. The interstitial adipose tissue provided a large amount of shielding for most of the organs in the abdomen region and reduces the absorbed dose to the liver so that it is the lowest absorbed dose of all organs for all isotopes. Although the bladder is in the abdomen region, it is located more towards the back of the individual. For the more penetrating radiation emitted by ⁶⁰Co, ¹⁹²Ir, ¹³⁷Cs and ¹³¹I, the adipose tissue did not provide effective shielding of the bladder, causing it to receive the largest absorbed dose. Similar to the reference male and female, the skin was the lowest contributor to the effective dose for the more penetrating radiation emitted by ⁶⁰Co, ¹⁹²Ir, ¹³⁷Cs and ¹³¹I. For ²⁴¹Am, the skin made the largest contribution to the effective dose due to the lower penetration power of the gamma ray emitted, and the lowest contributor to the effective dose rate was for the liver. Due to the fact that the male gonads are located on the outside of the body and the interstitial adipose tissue allows the gonads to see more body surface area, the gonads received the highest contribution to the effective dose rate for all isotopes.

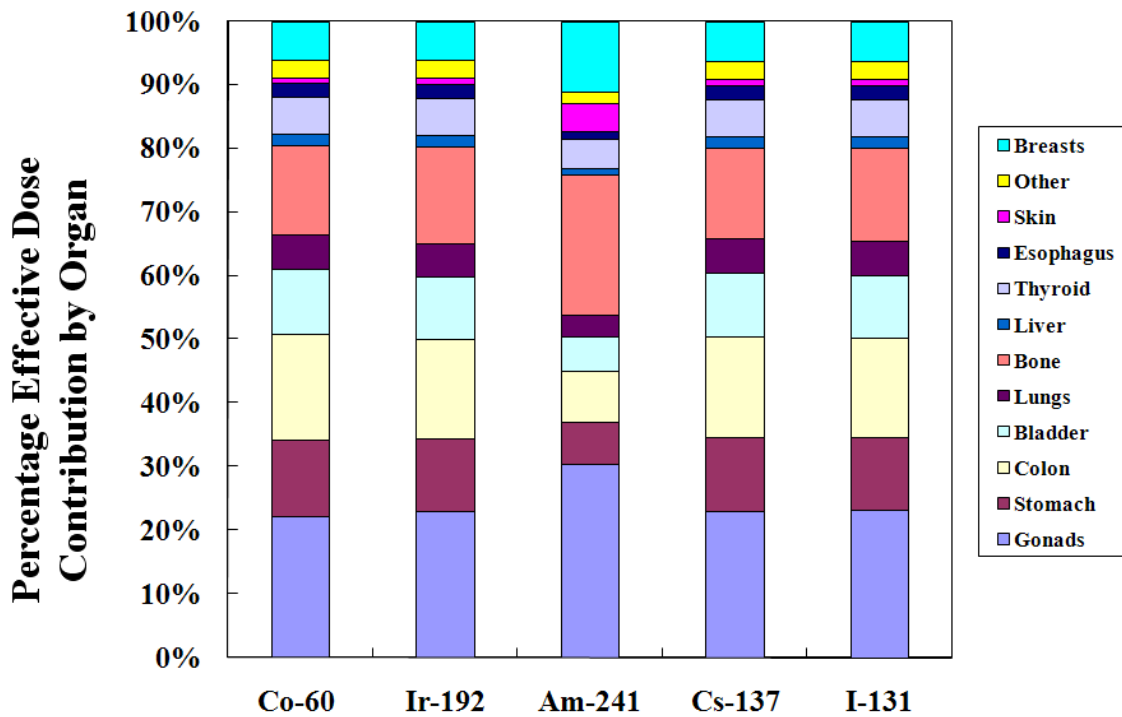

Figure 5.3 The Percentage of the Effective Dose Contributions by Organ for the Adipose Male

5.4 Adipose Female

The adipose female has a total external contamination of 74.481 GBq due to the 37 GBq/m² surface contamination level since it has a surface area of 2.013 m². The adipose female contains 15 kg of subcutaneous adipose tissue distributed on the torso, breasts, abdomen, and legs. The increased breast volume causes the breasts to have the highest organ absorbed dose. The distribution of adipose tissue around the torso increases the amount of shielding to organs, such as the bladder, but decreases the amount of shielding provided to the organs in the abdomen area when compared to the adipose male and postmenopausal adipose female. For ⁶⁰Co, ¹⁹²Ir, ¹³⁷Cs and ¹³¹I, the colon wall yielded the highest contribution to the effective dose for the adipose

female due to the increased surface area around the abdomen. Similar to the reference female, the ovaries received the lowest organ absorbed dose due to their internal location. Due to the small weighting factor for skin, the skin again yields the smallest effective dose rate. For ^{241}Am , the skin and bones received the maximum absorbed dose and the highest contribution to the effective dose, respectively, and the gonads and the liver received the minimum absorbed dose and the lowest contribution to the effective dose, respectively.

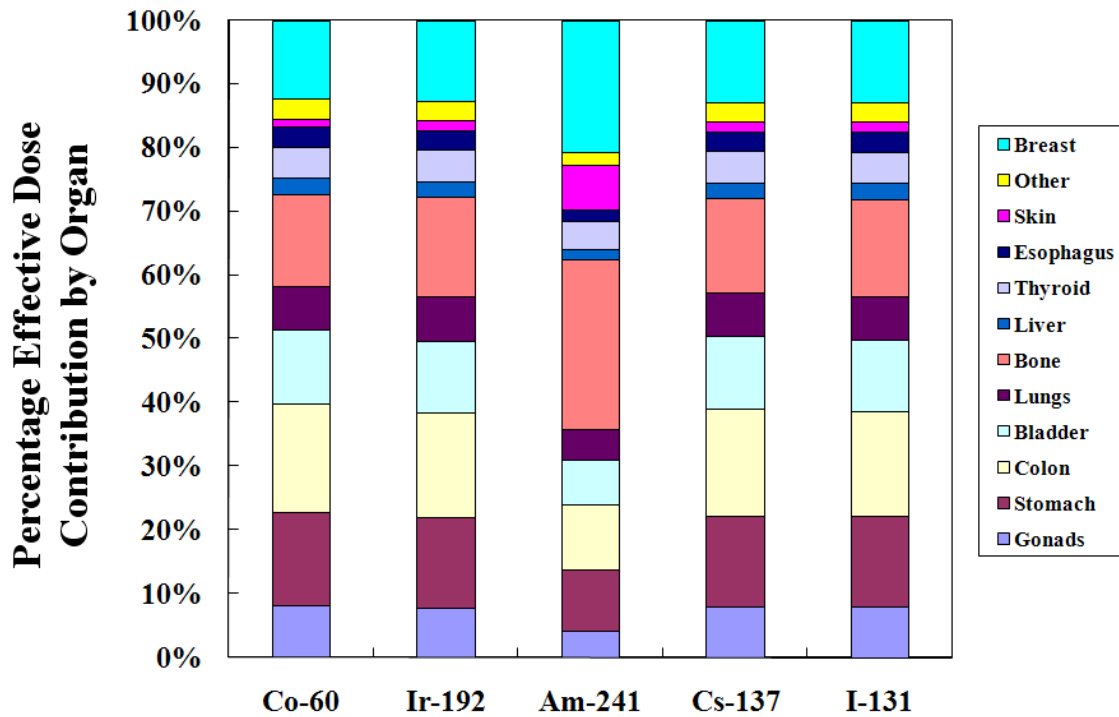

Figure 5.4 The Percentage of the Effective Dose Contributions by Organ for the Adipose Female

5.5 Postmenopausal Adipose Female

The postmenopausal adipose female contains an additional 27 kg of interstitial adipose tissue and has maximum contamination level of 79.476 GBq. The large amount of interstitial adipose tissue proves significant shielding for her internal organs in the abdomen area. For the more penetrating radiation emitted from ^{60}Co , ^{192}Ir , ^{137}Cs and ^{131}I , the breasts received the largest absorbed dose. The highest contribution to the effective dose is approximately equal for the postmenopausal adipose female: the gonads, the bone and the colon wall. The bladder, which was well shielded by the adipose tissue, received the smallest absorbed dose, and the skin again contributed the least to the effective dose. For ^{241}Am , the results are similar to the adipose female except that the liver was not only the lowest contributor to the effective dose but has the smallest absorbed dose.

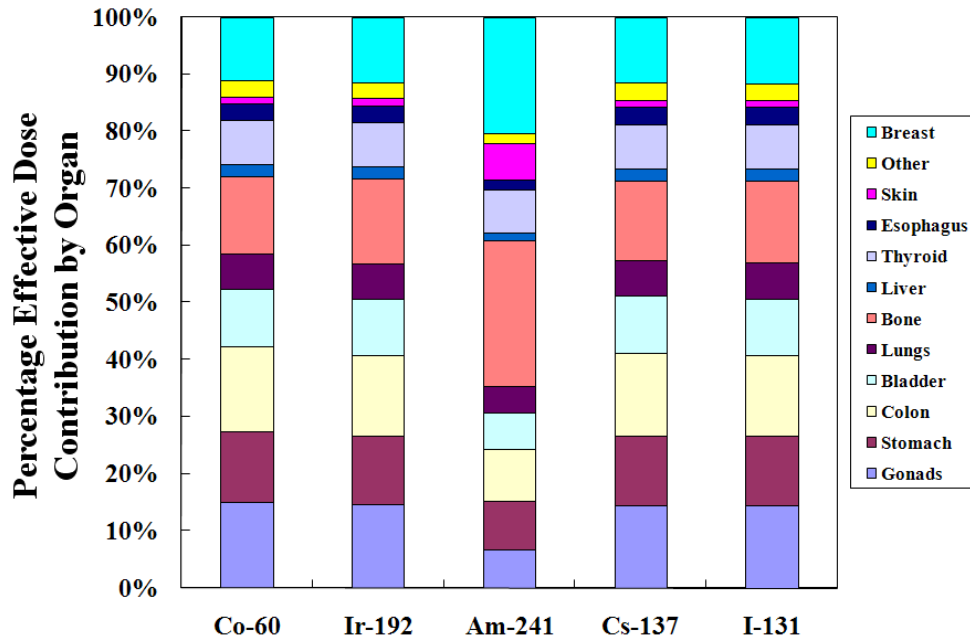

Figure 5.5 The Percentage of the Effective Dose Contributions by Organ for the Postmenopausal Adipose Female

5.6 Comparisons of Dose to Body Type

For all of the anthropomorphic phantoms considered, ^{60}Co produces the highest effective dose rate due to its two high energy gamma-rays. ^{241}Am results in the lowest effective dose rate due to its low energy gamma-ray emission. The dose rates due to the other isotopes are a function of energy and intensity of the gamma rays. ^{137}Cs has the second highest gamma ray energy and produces the second highest effective dose rate to the patient. ^{131}I emits gamma rays at energies higher than those emitted by ^{192}Ir , but not with as high of an intensity, giving ^{131}I the second lowest average effective dose rate. The dose to the patient for each isotope in addition to the average effective dose due to an isotope and the standard deviation is shown in Table 5.1.

Table 5.1 Dose to Patient from 37 GBq/m² Body Surface Contamination (mSv/hr)

Patient	^{60}Co	^{192}Ir	^{241}Am	^{137}Cs	^{131}I
Reference Male	197±0.66	75.5±0.38	2.61±0.03	48.6±0.15	28.2±0.08
Reference Female	167±0.69	64.3±0.25	2.32±0.01	41.2±0.16	24±0.09
Adipose Male	199±0.65	78.1±0.14	2.94±0.02	49.3±0.31	29±0.17
Adipose Female	173±0.56	67±0.15	2.3±0.02	42.6±0.33	24.9±0.12
Postmenopausal Adipose Female	181±1.02	70.3±0.30	2.29±0.03	44.3±0.48	26±0.26
Average	183.4	71.0	2.5	45.2	26.4
Standard Deviation	14.2	5.7	0.3	3.6	2.1

For all of the isotopes except ^{241}Am , there is a distinct pattern for the effective dose rate as a function of body type. The adipose male, who has the largest total contamination due to his body surface area, receives the highest dose. The reference male receives the second highest

dose. The doses to the male anthropomorphic phantoms are significantly higher than the doses received by the female phantoms due to the location of the male gonads. The reference female receives the smallest effective dose rate due to the external contamination, and the effective dose rate increases as a function of skin surface area for the female anthropomorphic phantoms. This shows that for the more penetrating radiation, the additional body fat does not compensate for the additional contamination due to a larger surface area for the adipose patient. The dose to each organ as a function of body type for ^{60}Co is depicted in Figure 5.6.

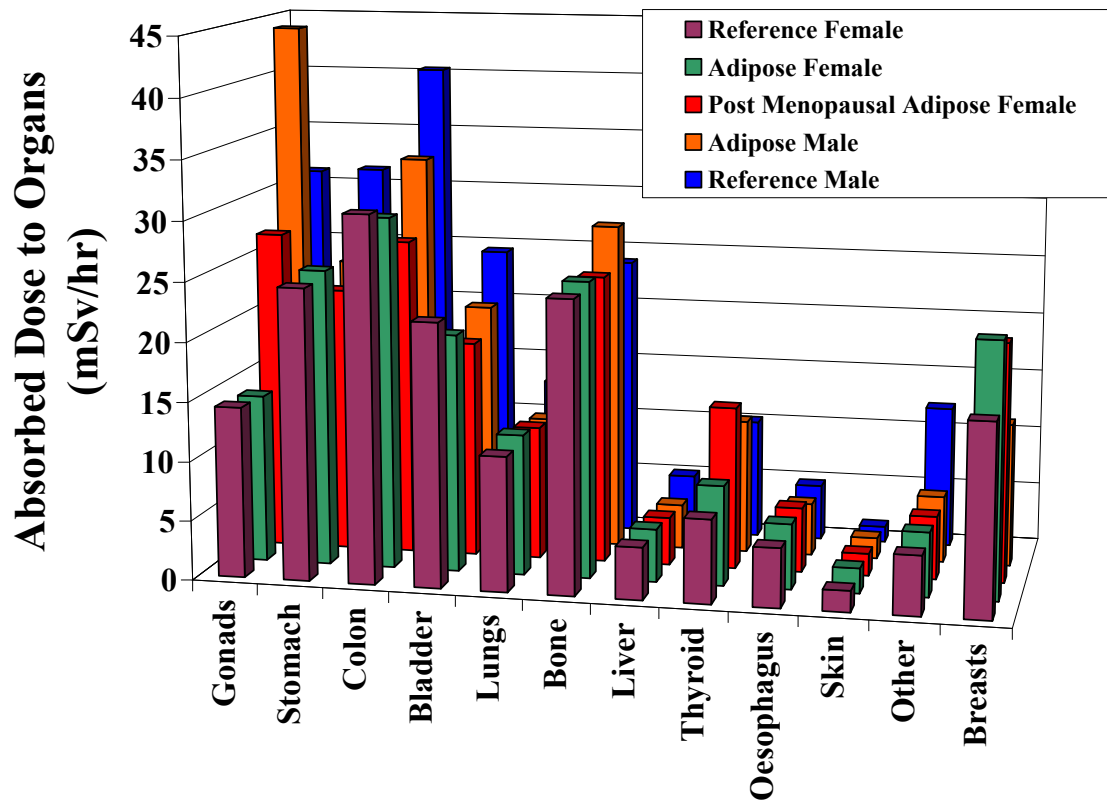

Figure 5.6 Absorbed Dose for Each Anthropomorphic Phantom 37 GBq/m² External Contamination of ^{60}Co (mSv/hr)

The pattern of dose as a function of body type of the patient is slightly different due to the low energy of the photon emitted by ^{241}Am . The male anthropomorphic phantoms again have higher effective dose than the female phantoms. The adipose male has the highest effective dose rate because the curvature of the stomach directs more radiation towards the gonads. The female dose rate actually decreases with increasing BMI. This is due to the ability of the adipose tissue to shield the radiosensitive organs on the female phantoms. The dose to each organ for ^{241}Am as a function of body type is shown in Figure 5.7. The amount of time an individual can be contaminated with 37GBq/m^2 of external contamination before receiving 250 mSv of dose is shown in Table 5.2.

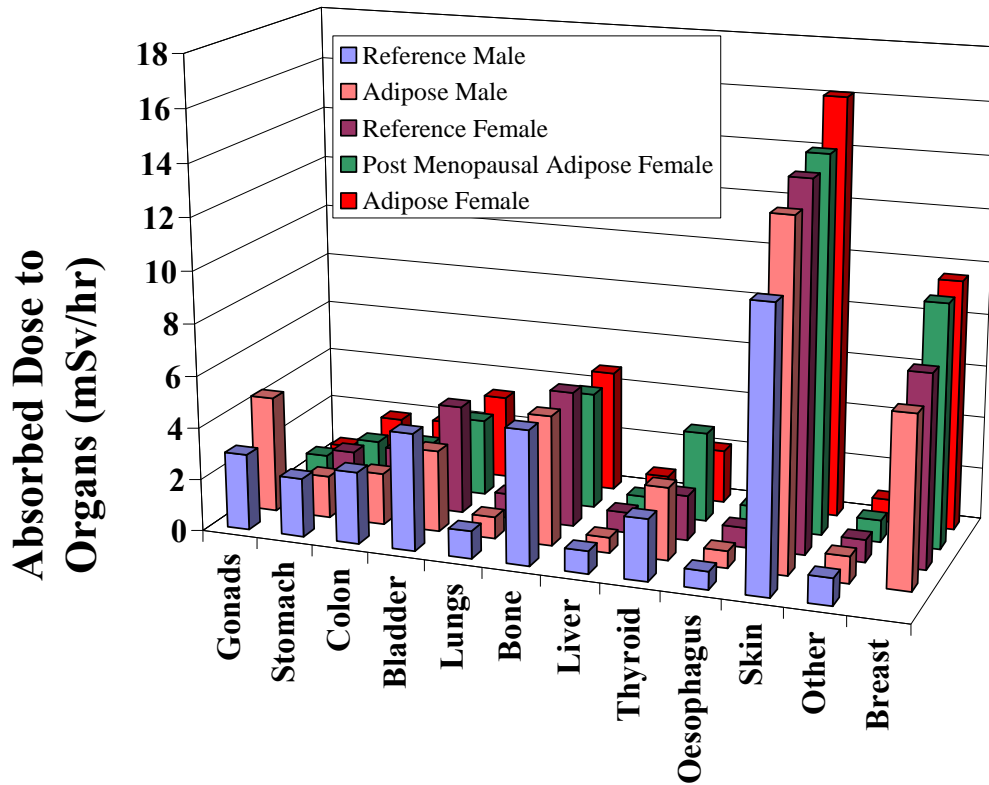

Figure 5.7 Absorbed Dose for Each Anthropomorphic Phantom 37GBq/m^2 External Contamination of ^{241}Am (mSv/hr)

Table 5.2 Time (Hours) Before an Individual with 37GBq/m² of External Contamination Receives 250 mSv Dose from Gamma Dose

Patient	⁶⁰ Co	¹⁹² Ir	²⁴¹ Am	¹³⁷ Cs	¹³¹ I
Reference Male	1.27	3.31	95.79	5.14	8.87
Reference Female	1.50	3.89	107.76	6.07	10.42
Adipose Male	1.26	3.20	85.03	5.07	8.62
Adipose Female	1.45	3.73	108.70	5.87	10.04
Postmenopausal Adipose Female	1.38	3.56	109.17	5.64	9.62
Average	1.36	3.52	100.00	5.53	9.47
Standard Deviation	0.11	0.29	10.65	0.44	0.76

5.7 Beta Dose to Patient

The beta dose to the patient was determined by assuming that all of the energy of the beta particles was deposited in the skin of the patient. The absorbed dose is found by dividing the energy emitted per disintegration by the mass of the skin and multiplying by the source strength which is proportional to the surface area of the phantom. Since the thickness of the skin for all phantoms is constant, the absorbed dose is the same for all the phantoms for a given isotope. The absorbed dose and the contribution to the effective dose are shown in Table 5.3.

Table 5.3 Absorbed Dose and Contribution to Effective Dose from Betas to the Patient's Skin

Patient	⁶⁰ Co	¹⁹² Ir	¹³⁷ Cs	¹³¹ I
Absorbed Dose (mGy/hr)	710.7	1265.7	1381.4	1342.1
Contribution to Effective Dose (mSv/hr)	7.1	12.7	13.8	13.4

The total dose to the patient was increased by the addition of the beta dose to the skin.

The total dose to the patient and the time it would take for the patient to receive the 250mSv dose are shown in Tables 5.4 and 5.5.

Table 5.4 Effective Dose to Patient From Gammas and Betas for 37Gq/m² External Contamination (mSv/hr)

Patient	⁶⁰Co	¹⁹²Ir	¹³⁷Cs	¹³¹I
Reference Male	204.1	88.2	62.4	41.6
Reference Female	174.1	77.0	55.0	24.0
Adipose Male	206.1	90.8	63.1	29.0
Adipose Female	180.1	79.7	56.4	24.9
Postmenopausal Adipose Female	188.1	83.0	58.1	26.0

5.5 Time in Hours it Takes the Patient to Receive 250mSv Effective Dose

Patient	⁶⁰Co	¹⁹²Ir	¹³⁷Cs	¹³¹I
Reference Male	1.2	2.8	4.0	6.0
Reference Female	1.4	3.2	4.5	10.4
Adipose Male	1.2	2.8	4.0	8.6
Adipose Female	1.4	3.1	4.4	10.0
Postmenopausal Adipose Female	1.3	3.0	4.3	9.6
Average	1.3	3.0	4.2	8.9
Standard Deviation	0.10	0.21	0.26	1.77

CHAPTER 6

CONCLUSIONS

It is important for the healthcare industry to understand the dose rates associated with attending to both internally and externally contaminated patients and consider the amount of time required to perform a lifesaving procedure. A healthcare provider can attend to a patient that is contaminated with 37GBq/m^2 of ^{60}Co is 1.6 hours before receiving the 50 mSv. It would take 8.3 hours for the healthcare provider to receive the EPA limit of 250 mSv lifesaving dose. The externally contaminated patient would receive 1694 mSv in 8.3 hours. The removal of the clothes from the externally contaminated patient will remove approximately 90% of the contamination, reducing the dose to both the patient and the healthcare provider. For internally contaminated patients, the effective doses to the healthcare provider are lower. For a patient internally contaminated after a 1 ALI intake of ^{192}Ir assuming a fast inhalation class, the healthcare provider would receive a dose rate of $3.7\ \mu\text{Sv/hour}$.

The possibility of the patient having radioactive shrapnel which may need to be surgically removed would be an additional scenario of concern to the healthcare industry. The shrapnel may range in activity from 37 to 3700 GBq. This scenario should be considered in future work.

APPENDIX A

COMPOSITION OF SURGICAL TABLE

Table A.1 Composition of Polyurethane Foam [7]

Polyurethane	Weight Percent
H	8.874
C	64.056
N	3.401
O	23.629
Cl	0.04

Table A.2 Composition of Grade 304 Stainless Steel [9]

Material	Weight Percent
Fe	65.845
C	0.08
Cr	20
Ni	11
Mn	2
Si	1
P	0.045
S	0.03

APPENDIX B

MASS OF EACH COMPARTMENT OF PHANTOMS

Table B.1 Mass of Compartments of Anthropomorphic Phantoms in Grams [2]

Compartment	Reference Male	Reference Female	Adipose Male	Adipose Female	Postmenopausal Adipose Female
Gonads	34.66	10.71	34.66	10.71	5
Stomach	150	140	150	140	140
Ascending Colon	90	90	90	90	90
Sigmoid Colon	70	70	70	70	70
Transverse Colon	120	110	120	110	110
Descending Colon	90	90	90	90	90
Bladder	45	45	45	45	45
Lungs	1000	800	1000	800	800
Bone	5500	4500	5500	4500	4500
Liver	1820	1440	1820	1440	1430
Thyroid	20.5	20.5	20.5	20.5	13.4
Esophagus	40	30	40	30	30
Skin	2600	1790	3640	2002	2352
Other	3053.5	2681.5	3308.5	2681.5	2684
Breasts	0	280	280	400	400

APPENDIX C

REFENCE MALE INPUT FILE

Neutron & Induced Photon Flux Calculations in MIRD Phantom: Oes & Colon Wall
C Co-60 Skin Source

```
1 1 -0.001293 -1 (607:-37:606) (-606:601:35) (600:-35) &
    (-615:37:-43:44:4:-616) (37:-608:609) &
    (37:-608:610) IMP:P=1 IMP:E=1
2 2 -0.2958 ((-2 -4 3):(-2 4)) 5 IMP:P=1 IMP:E=1 VOL=9.89817E3 $ left lung
3 3 -0.9869 -7 51 -6 (-8:32) 84 101 #2 #24 #28 #58 #59 #62 #700 &
    (113:115) (114:115) IMP:P=1 IMP:E=1 VOL=5.12539E4 $ torso insd ribs/lvrtpop-shldr
4 3 -0.9869 -7 8 -32 117 113 114 #15 #16 #17 #18 #19 &
    (-4:-9:116:118:-119) (-4:-9:116:120:-121) &
    #20 #700 IMP:P=1 IMP:E=1 VOL=7.01171E3 $ torso
5 3 -0.9869 -7 8 -117 51 113 114 #9 #13 #14 &
    #700 IMP:P=1 IMP:E=1 VOL=4.12839E3 $ torso
6 3 -0.9869 -7 50 -51 56 84 96 105 106 113 114 #10 #11 #12 #27 &
    #32 #43 #44 #47 #700 IMP:P=1 IMP:E=1 VOL=3.75367E4 $ torso
7 3 -0.9869 -7 97 -50 (83:-86:87:-88) 113 114 #30 #33 #38 #39 &
    #63 #64 #65 #700 IMP:P=1 IMP:E=1 VOL=4.1204E4 $ torso abdomen
8 3 -0.9869 -7 37 -97 95 113 114 #31 #33 #38 #65 #66 &
    #700 IMP:P=1 IMP:E=1 VOL=3.96266E4 $ torso abdomen
9 4 -1.4862 8 -9 5 -10 IMP:P=1 IMP:E=1 VOL=3.42E2 $ rib
10 4 -1.4862 8 -9 11 -12 IMP:P=1 IMP:E=1 VOL=3.42E2 $ rib
11 4 -1.4862 8 -9 13 -14 IMP:P=1 IMP:E=1 VOL=3.42E2 $ rib
12 4 -1.4862 8 -9 15 -16 IMP:P=1 IMP:E=1 VOL=3.42E2 $ rib
13 4 -1.4862 8 -9 17 -18 IMP:P=1 IMP:E=1 VOL=3.42E2 $ rib
14 4 -1.4862 8 -9 19 -20 IMP:P=1 IMP:E=1 VOL=3.42E2 $ rib
15 4 -1.4862 8 -9 21 -22 IMP:P=1 IMP:E=1 VOL=3.42E2 $ rib
16 4 -1.4862 8 -9 23 -24 IMP:P=1 IMP:E=1 VOL=3.42E2 $ rib
17 4 -1.4862 8 -9 25 -26 IMP:P=1 IMP:E=1 VOL=3.42E2 $ rib
18 4 -1.4862 8 -9 27 -28 IMP:P=1 IMP:E=1 VOL=3.42E2 $ rib
19 4 -1.4862 8 -9 29 -30 IMP:P=1 IMP:E=1 VOL=3.42E2 $ rib
20 4 -1.4862 8 -9 31 -32 IMP:P=1 IMP:E=1 VOL=3.42E2 $ rib
21 3 -0.9869 ((35 -34):(-33 6 -35)) 102 (84:85)
    #37 #60 #61 #62 #700 IMP:P=1 IMP:E=1 VOL=1.09049E4 $ head
22 3 -0.9869 -37 38 -39 103 #700 IMP:P=1 IMP:E=1 VOL=5.26806E4 $ left leg
23 3 -0.9869 -37 38 -40 104 #22 #700 IMP:P=1 IMP:E=1 VOL=5.26806E4 $ right leg
24 2 -0.2958 ((-41 -4 42):(-41 4)) 5 IMP:P=1 IMP:E=1 VOL=9.87788E3 $ right lung
25 3 -0.9869 715 -37 43 -44 -4 716 39 40 72 73 #700 &
    #600 IMP:P=1 IMP:E=1 VOL=8.35231E2 $ genitalia
26 3 -0.9869 -47 IMP:P=1 IMP:E=1 VOL=8.24983E3 $ brain
27 3 -0.9869 50 -51 -48 -49 #10 #11 #12 IMP:P=1 IMP:E=1 VOL=1.085E4 $ liver
28 3 -0.9869 (-52 54):(-53 -54 55) IMP:P=1 IMP:E=1 VOL=3.48665E3 $ heart
29 3 -0.9869 -56 IMP:P=1 IMP:E=1 VOL=2.39203E3 $ stomach
30 3 -0.9869 138 -57 58 -59 IMP:P=1 IMP:E=1 VOL=5.46974E2 $ Ascending Colon Wall
31 3 -0.9869 (-63 141 65 -61) : (-64 142 37 -65) &
    IMP:P=1 IMP:E=1 VOL=4.19631E2 $ Sigmoid Colon Wall
32 3 -0.9869 -62 139 66 -67 59 IMP:P=1 IMP:E=1 VOL=7.21861E2 $ Transverse Colon Wall
33 3 -0.9869 -60 140 61 -59 -83 IMP:P=1 IMP:E=1 VOL=5.2306E2 $ Descending Colon Wall
35 3 -0.9869 -72 IMP:P=1 IMP:E=1 VOL=1.11E2 $ testicle
```

36 3 -0.9869 -73 IMP:P=1 IMP:E=1 VOL=1.11E2 \$ testicle
37 3 -0.9869 -74 75 -76 6 -77 IMP:P=1 IMP:E=1 VOL=1.72154E2 \$ thyroid
38 4 -1.4862 -82 83 37 -78 80 (79:-81) IMP:P=1 IMP:E=1 VOL=3.63227E3 \$ pelvis
39 4 -1.4862 -84 78 -85 102 IMP:P=1 IMP:E=1 VOL=5.17342E3 \$ spine
40 3 -0.9869 -83 86 -50 88 -87 #30 #32 #33 #63 #64 #65 &
IMP:P=1 IMP:E=1 VOL=6.31233E3 \$ small int.
41 1 -0.001293 -107 606 -4 IMP:P=1 IMP:E=1 \$ air
42 1 -0.001293 -108 606 -4 IMP:P=1 IMP:E=1 \$ air
43 3 -0.9869 -92 65 IMP:P=1 IMP:E=1 VOL=8.5E2 \$ kidney
44 3 -0.9869 -93 -94 IMP:P=1 IMP:E=1 VOL=8.5E2 \$ kidney
45 3 -0.9869 -95 IMP:P=1 IMP:E=1 VOL=1.48895E3 \$ bladder
46 3 -0.9869 -96 IMP:P=1 IMP:E=1 VOL=1.04544E3 \$ spleen
47 3 -0.9869 -98 99 (-65:100) IMP:P=1 IMP:E=1 VOL=3.58882E2 \$ pancreas
48 3 -0.9869 -101 IMP:P=1 IMP:E=1 VOL=1.45325E2 \$ thymus
49 4 -1.4862 47 -102 #60 #61 IMP:P=1 IMP:E=1 VOL=4.77509E3 \$ skull
50 4 -1.4862 -103 38 -37 IMP:P=1 IMP:E=1 VOL=8.2E3 \$ leg bone
51 4 -1.4862 -104 38 -37 IMP:P=1 IMP:E=1 VOL=8.2E3 \$ leg bone
52 3 -0.9869 -105 92 IMP:P=1 IMP:E=1 VOL=5.8E1 \$ adrenal
53 3 -0.9869 -106 93 IMP:P=1 IMP:E=1 VOL=5.8E1 \$ adrenal
54 4 -1.4862 37 -115 -113 IMP:P=1 IMP:E=1 VOL=2.8E3 \$ arm bone
55 4 -1.4862 37 -115 -114 IMP:P=1 IMP:E=1 VOL=2.8E3 \$ arm bone
56 4 -1.4862 4 9 -32 -116 117 -118 119 IMP:P=1 IMP:E=1 VOL=5.85E2 \$ scapulae
57 4 -1.4862 4 9 -32 -116 117 -120 121 IMP:P=1 IMP:E=1 VOL=5.85E2 \$ scapulae
58 4 -1.4862 -4 -122 -123 124 IMP:P=1 IMP:E=1 VOL=1.56E2 \$ clavicle
59 4 -1.4862 -4 -122 -125 126 IMP:P=1 IMP:E=1 VOL=1.56E2 \$ clavicle
60 3 -0.9869 -33 128 129 -130 133 -134 -4 #700 &
IMP:P=1 IMP:E=1 VOL=1.1E1 \$ eye lense
61 3 -0.9869 -33 128 -131 132 133 -134 -4 #700 &
IMP:P=1 IMP:E=1 VOL=1.1E1 \$ eye lense
62 3 -0.9869 -77 -137 51 IMP:P=1 IMP:E=1 VOL=2.31698E2 \$ oesophagus
63 3 -0.9869 -138 58 -59 IMP:P=1 IMP:E=1 VOL=5.781E2 \$ Ascending Colon Interior
64 3 -0.9869 -139 66 -67 IMP:P=1 IMP:E=1 VOL=7.58053E2 \$ Transvers Colon Interior
65 3 -0.9869 -140 61 -59 -83 IMP:P=1 IMP:E=1 VOL=6.152E2 \$ Descending Colon Interior
66 3 -0.9869 (-141 65 -61) : (-142 37 -65) &
IMP:P=1 IMP:E=1 VOL=2.15848E2 \$ Sigmoid Colon Interior
600 0 -600 35 34 : -601 33 -35 606 : & \$ Head & Neck
-606 6 33 -607 : -607 7 -6 37 : & \$ Shoulders & Torso
(((-46 616) (43 -44) (615 -37)) : &
((615 -45 -4)(610 609)(46 -4)(43 -44))) : & \$ Genitalia
-610 40 -37 38 : -609 39 -37 38 : & \$ Legs
-708 608 -609 : -708 608 -610 : -38 708 -610 40 : & \$ Feet
-38 708 -609 39 IMP:P=1 IMP:E=1 VOL=1.23531E4
700 5 -1.04 700 35 102 -34 : 701 -33 -35 6 : & \$ Head & Neck
706 -6 701 -707 : 707 -7 -6 37 114 113 : & \$ Shoulders & Torso
(((46 -716)(43 -44)(609 610)(715 -37)) : &
((-715 45)(610 609)(46 -4)(43 -44))) : & \$ Genitalia
-40 710 -37 38 : -39 709 -37 38 : & \$ Legs
-38 708 -39 : -38 708 -40 IMP:P=1 IMP:E=1 VOL=1.09131E4 \$ Feet
67 0 1 IMP:P=0 IMP:E=0
1 RPP -20.201 20.201 -10.205 10.202 -80.416 94.201
2 SQ 23.04 10.24 1 0 0 0 -576 8.5 0 43.5
3 SQ 23.04 10.24 1 0 0 0 -576 2.5 0 43.5
4 PY 0.0
5 PZ 43.5
6 PZ 70

706 PZ 69.8
606 PZ 70.2
7 SQ 1 4.0 0 0 0 0 -400.0 0 0 0
707 SQ 0.002551 0.010412 0 0 0 0 -1 0 0 0
607 SQ 0.002451 0.00961 0 0 0 0 -1 0 0 0
8 SQ 1 3.15 0 0 0 0 -272.25 0 0 0
9 SQ 1 3.01 0 0 0 0 -289.0 0 0 0
10 PZ 44.9
11 PZ 35.1
12 PZ 36.5
13 PZ 37.9
14 PZ 39.3
15 PZ 40.7
16 PZ 42.1
17 PZ 46.3
18 PZ 47.7
19 PZ 49.1
20 PZ 50.5
21 PZ 51.9
22 PZ 53.3
23 PZ 54.7
24 PZ 56.1
25 PZ 57.5
26 PZ 58.9
27 PZ 60.3
28 PZ 61.7
29 PZ 63.1
30 PZ 64.5
31 PZ 65.9
32 PZ 67.3
33 SQ 100 49 0 0 0 0 -4900 0 0 0
701 SQ 0.021626 0.010412 0 0 0 0 -1 0 0 0
601 SQ 0.01929 0.009612 0 0 0 0 -1 0 0 0
34 SQ 7225 3540.25 4900 0 0 0 -354025 0 0 85.5
700 SQ 0.021626 0.010412 0.014516 0 0 0 -1 0 0 85.5
600 SQ 0.01929 0.009612 0.013212 0 0 0 -1 0 0 85.5
35 PZ 85.5
36 PZ 94
37 PZ 0
38 PZ -80
708 PZ -80.215
608 PZ -80.415
39 601 GQ 5.025 5 0 0 0 -1 -100 0 0 0
709 603 GQ 5.05 5 0 0 0 -1 -100 0 0 0
609 605 GQ 4.963 5 0 0 0 -1 -100 0 0 0
40 600 GQ 5.025 5 0 0 0 1 100 0 0 0
710 602 GQ 5.089 5 0 0 0 1 100 0 0 0
610 604 GQ 4.963 5 0 0 0 1 100 0 0 0
41 SQ 23.04 10.24 1 0 0 0 -576 -8.5 0 43.5
42 SQ 23.04 10.24 1 0 0 0 -576 -2.5 0 43.5
43 P 10 0 1 -100
44 P 10 0 -1 100
45 PZ -4.8
715 PZ -4.6
615 PZ -5.0
46 P 0 10 1 -100

716 P 0 10.2 1 -100
616 P 0 9.8 1 -100
47 SQ 2.25 1 1.91716 0 0 0 -81 0 0 86.5
48 SQ 64 272.25 0 0 0 0 -17424 0 0 0
49 P 9 7 -7.3256 -315
50 PZ 27
51 PZ 43
52 GQ 45.2 59.9 47.9 17.5 -16.2 34.8 -1632.1 1204.8 -4898.2 124295.2
53 SQ 1 1 1 0 0 0 -25 -1 -3 51
54 P .6943 -.3237 -.6428 -32.506
55 P 5.2193 -2.4336 -0.916 -59.6345
56 SQ 4 7.11 1 0 0 0 -64 8 -4 35
57 SQ 1 1 0 0 0 0 -6.25 -8.5 -2.36 0
58 PZ 14.45
59 PZ 24
60 GQ 4.54 3.53 .096 0 1.16 -0.166 -77.68 -10.08 -.223 323.52
61 PZ 8.72
62 SQ 0 2.25 6.25 0 0 0 -14.0625 0 -2.36 25.5
63 TY 3 0 8.72 5.72 1.57 1.57
64 TY 3 0 0 3 1.57 1.57
65 PX 3
66 PX -10.5
67 PX 10.5
68 PX -20
69 PX 20
70 PY -30
71 PY -29
72 SQ 11.9025 8.9401 3.8025 0 0 0 -20.115225 1.3 -8 -2.3
73 SQ 11.9025 8.9401 3.8025 0 0 0 -20.115225 -1.3 -8 -2.3
74 C/Z 0 -6 2.2
75 C/Z 0 -6 1
76 PY -6
77 PZ 75
78 PZ 22
79 PZ 14
80 PY -3
81 PY 5
82 C/Z 0 -3 12
83 C/Z 0 -3.8 11.3
84 SQ 6.25 4 0 0 0 0 -25 0 5.5 0
85 PZ 78.5
86 PZ 17
87 PY 2.2
88 PY -4.86
89 C/Z 0 -11. 0.6350
90 C/Z 0 -11. 0.8636
91 PZ 56.335
92 SQ 1.49 13.44 1 0 0 0 -30.25 6 6 32.5
93 SQ 1.49 13.44 1 0 0 0 -30.25 -6 6 32.5
94 PX -3
95 SQ 1 2.0557 2.0557 0 0 0 -24.5818 0 -4.5 8
96 SQ 2.94 9 1 0 0 0 -36 11 3 37
97 PZ 12
98 SQ 1 225 25 0 0 0 -225 0 0 37
99 PX 0
100 PZ 37

101 SQ 1.78 64 1 0 0 0 -16 -2 -6 60.5
102 SQ 2.08 1 1.39 0 0 0 -96.04 0 0 85.5
103 GQ 1 1 .0091 0 0 -.2005 -20 0 1.7857 87.75
104 GQ 1 1 .0091 0 0 .2005 20 0 1.7857 87.75
105 SQ 100 900 9 0 0 0 -225 4.5 6.5 38
106 SQ 100 900 9 0 0 0 -225 -4.5 6.5 38
107 SQ 1.39 .5 2 0 0 0 -70 -6.5 -3 50
108 SQ 1.39 .5 2 0 0 0 -70 6.5 -3 50
109 PX 17
110 PX 6
111 PX -6
112 PX -17
113 GQ 503.01 135.24 0 0 0 10.206 -19215 0 -202.0788 183257
114 GQ 503.01 135.24 0 0 0 -10.206 19215 0 -202.0788 183257
115 PZ 69
116 SQ 1 3.7589 0 0 0 0 -361 0 0 0
117 PZ 50.9
118 P 0.25 -1 0 0
119 P 0.8 -1 0 0
120 P -0.25 -1 0 0
121 P -0.8 -1 0 0
122 TZ 0 11.1 68.25 20 0.7883 0.7883
123 P 0.89415 1 0 11.1
124 P 7.0342 1 0 11.1
125 P -0.89415 1 0 11.1
126 P -7.0342 1 0 11.1
C 2 concentric elliptical cylinders and planes to define eye lenses
127 SQ 100 64 0 0 0 0 -6400 0 0 0
128 SQ 88.36 40.96 0 0 0 0 -3619.2256 0 0 0
129 PX 2
130 PX 4
131 PX -2
132 PX -4
133 PZ 82.5
134 PZ 84.5
C segmenting planes for RBM regions in leg and arm bones
135 PZ -22.8
136 PZ 52.6
C Oesophagus
137 SQ 0.16 1.0 0 0 0 0 -0.16 0.5 2.5 0 \$ Oesophagus Exterior
C Colon Wall
138 SQ 1 1 0 0 0 0 -3.209 -8.5 -2.36 0 \$ Ascending Colon Interior
139 SQ 0 0.9467 3.8927 0 0 0 -3.6854 0 -2.36 25.5
140 GQ 1.796 2.496 0.0674 0 0.818 -0.066 -30.75 -7.12 -0.602 132.2
141 TY 3 0 8.72 5.72 0.91 0.91 \$ Upper Sigmoid Interior
142 TY 3 0 0 3 0.91 0.91 \$ Lower Sigmoid Interior

C Data Cards

tr600 -0.1
tr601 0.1
tr602 -0.15
tr603 0.15
tr604 -0.051
tr605 0.051

C

C Source Cards

SDEF PAR=2 ERG=D1 CEL=600 POS 0 0 -80.5
RAD=D3 EXT=D4 EFF=1E-4 AXS 0 0 1
SII L 1.173 1.332
SP1 0.9985 0.999826
SI3 0 20.21
SP3 -21 1
SI4 0 174.75
SP4 -21 0
C
C Tally Cards
*F8:P 35 36 T
FC8 Gonad Gamma Dose
*F18:E 35 36 T
FC18 Gonad Electron Dose
*F28:P 37
FC28 Thyroid Gamma Dose
*F38:E 37
FC38 Thyroid Electron Dose
*F48:P 9 10 11 12 13 14 15 16 17 18 19 20 38 39 49
50 51 54 55 56 57 58 59 T
FC48 Bone Gamma Dose
*F58:E 9 10 11 12 13 14 15 16 17 18 19 20 38 39 49
50 51 54 55 56 57 58 59 T
FC58 Bone Electron Dose
*F68:P 2 24 T
FC68 Lung Gamma Dose
*F78:E 2 24 T
FC78 Lung Electron Dose
*F88:P 29
FC88 Stomach Gamma Dose
*F98:E 29
FC98 Stomach Electron Dose
*F108:P 30 31 32 33 63 64 65 66
FC108 Colon Gamma Dose
*F118:E 30 31 32 33 63 64 65 66
FC118 Colon Electron Dose
*F128:P 45
FC128 Bladder Gamma Dose
*F138:E 45
FC138 Bladder Electron Dose
*F148:P 27
FC148 Liver Gamma Dose
*F158:E 27
FC158 Liver Electron Dose
*F168:P 62
FC168 Oesophagus Gamma Dose
*F178:E 62
FC178 Oesophagus Electron Dose
*F188:P 700
FC188 Skin Gamma Dose
*F198:E 700
FC198 Skin Electron Dose
C
C Material Cards
C THIS IS THE COMPOSITION FOR AIR
M1 7014 -.7558 8016 -.2314 18000 -.0128

C THIS IS THE COMPOSITION FOR LUNG TISSUE

M2 1001 -.1021

6012 -.1001
7014 -.0280
8016 -.7596
11023 -.0019
15031 -.0008
16032 -.0023
17000 -.0027
19000 -.0020
20000 -.0001
26000 -.0004

C THE COMPOSITION FOR TOTAL BODY MINUS SKELETON AND LUNGS

M3 1001 -.1047

6012 -.2302
7014 -.0234
8016 -.6321
11023 -.0013
12000 -.0002
15031 -.0024
16032 -.0022
17000 -.0014
19000 -.0021

C THE COMPOSITION FOR SKELETAL TISSUE

M4 1001 -.0704

6012 -.2279
8016 -.4856
7014 -.0387
11023 -.0032
12000 -.0011
15031 -.0694
16032 -.0017
17000 -.0014
19000 -.0015
20000 -.0991

c Adult Tissues (Density = 1.04 g/cc)

M5 1001 -.10454

6012 -0.22663
7014 -0.02490
8016 -0.63525
11023 -0.00112
12000 -0.00013
14000 -0.00030
15031 -0.00134
16032 -0.00204
17000 -0.00133
19000 -0.00208
20000 -0.00024
26000 -0.00005
30000 -0.00003
37085 -0.000007217
37087 -0.000002783
40000 -0.00001

C

NPS 1.5E8

RAND GEN=2 SEED=1561615651

PHYS:P 4J 1
PRINT
MODE P E

APPENDIX D

REFENCE FEMALE INPUT FILE

Neutron & Induced Photon Calculations in MIRDETTE Phantom: Oes & Colon Wall
C Am-241 Skin Source

```
1  1 -.001293 -1 (607:-37:606) (-606:601:35)
    (600:-35) (603:4) (604:4) #600
    (37:-608:609) (37:-608:610) IMP:P=1 IMP:E=1
2  2 -0.2958 ((-2 -4 3):(-2 4)) 5 IMP:P=1 VOL=8.22E3 IMP:E=1 $ left lung
3  3 -0.9869 -7 5 -6 (-8:32) 84 101 #2 #24 #28 #54 &
    #55 #58 #59 #62 #700 IMP:P=1 VOL=4.09E4 IMP:E=1
4  3 -0.9869 -7 8 -32 116 112 113 #15 #16 #17 #18 &
    #19 #20 #56 #57 #700 IMP:P=1 VOL=6.33E3 IMP:E=1
5  3 -0.9869 -7 8 -116 5 112 113 #9 #13 #14 &
    #700 IMP:P=1 VOL=3.33E3 IMP:E=1 $ torso
6  3 -0.9869 -7 50 -5 56 84 96 105 106 112 113 #10
    #11 #12 #27 #43 #44 #47 &
    #700 IMP:P=1 VOL=3.29E4 IMP:E=1 $ torso
7  3 -0.9869 -7 97 -50 (83:-86:87:-88)72 73 112 113
    #25 #30 #33 #38 #39 #43 #44 #63 #64 &
    #65 #700 IMP:P=1 VOL=3.43E4 IMP:E=1
8  3 -0.9869 -7 37 -97 95 112 113 #31 #33 #38 #65 &
    #66 #700 IMP:P=1 VOL=3.18E4 IMP:E=1 $ torso
9  4 -1.4862 8 -9 5 -10 IMP:P=1 VOL=2.83E2 IMP:E=1 $ rib
10 4 -1.4862 8 -9 11 -12 IMP:P=1 VOL=2.83E2 IMP:E=1 $ rib
11 4 -1.4862 8 -9 13 -14 IMP:P=1 VOL=2.83E2 IMP:E=1 $ rib
12 4 -1.4862 8 -9 15 -16 IMP:P=1 VOL=2.83E2 IMP:E=1 $ rib
13 4 -1.4862 8 -9 17 -18 IMP:P=1 VOL=2.83E2 IMP:E=1 $ rib
14 4 -1.4862 8 -9 19 -20 IMP:P=1 VOL=2.83E2 IMP:E=1 $ rib
15 4 -1.4862 8 -9 21 -22 IMP:P=1 VOL=2.83E2 IMP:E=1 $ rib
16 4 -1.4862 8 -9 23 -24 IMP:P=1 VOL=2.83E2 IMP:E=1 $ rib
17 4 -1.4862 8 -9 25 -26 IMP:P=1 VOL=2.83E2 IMP:E=1 $ rib
18 4 -1.4862 8 -9 27 -28 IMP:P=1 VOL=2.83E2 IMP:E=1 $ rib
19 4 -1.4862 8 -9 29 -30 IMP:P=1 VOL=2.83E2 IMP:E=1 $ rib
20 4 -1.4862 8 -9 31 -32 IMP:P=1 VOL=2.83E2 IMP:E=1 $ rib
21 3 -0.9869 ((35 -34):(-33 6 -35)) 102 (84:85) #37
    #60 #61 #62 #700 IMP:P=1 VOL=9.27E3 IMP:E=1 $ head
22 3 -0.9869 -37 38 -39 103 #700 IMP:P=1 VOL=4.21E4 IMP:E=1 $ left leg
23 3 -0.9869 -37 38 -40 104 #22 #700 IMP:P=1 &
    VOL=4.21E4 IMP:E=1 $ right leg
24 2 -0.2958 ((-41 -4 42):(-41 4)) 5 IMP:P=1 &
    VOL=8.22E3 IMP:E=1 $ right lung
25 3 -0.9869 45 -46 IMP:P=1 VOL=4.89E2 IMP:E=1 $ uterus
26 3 -0.9869 -47 IMP:P=1 VOL=6.97E3 IMP:E=1 $ brain
27 3 -0.9869 50 -51 -48 -49 IMP:P=1 VOL=8.84E3 IMP:E=1 $ liver
28 3 -0.9869 (-52 54):(-53 -54 55) IMP:P=1 &
    VOL=3.01E3 IMP:E=1 $ heart
29 3 -0.9869 -56 IMP:P=1 VOL=1.99E3 IMP:E=1 $ stomach
30 3 -0.9869 -57 138 58 -59 IMP:P=1 VOL=4.51E2 IMP:E=1 $ Ascending Colon Wall
31 3 -0.9869 (-63 141 65 -61):(-64 142 37 -65) &
    IMP:P=1 VOL=3.49E2 IMP:E=1 $ Sigmoid Colon Wall
```

32 3 -0.9869 -62 139 66 -67 IMP:P=1 VOL=6.00E2 IMP:E=1 \$ Transverse Colon Wall
33 3 -0.9869 -60 140 61 -59 -83 IMP:P=1 VOL=4.28E2 IMP:E=1 \$ Descending Colon wall
35 3 -0.9869 -72 IMP:P=1 VOL=3.29E1 IMP:E=1 \$ ovary
36 3 -0.9869 -73 IMP:P=1 VOL=3.29E1 IMP:E=1 \$ ovary
37 3 -0.9869 -74 75 -76 6 -77 IMP:P=1 VOL=1.44E2 IMP:E=1 \$ thyroid
38 4 -1.4862 -82 83 37 -78 80 (79:-81) &
IMP:P=1 VOL=3.02E3 IMP:E=1 \$ pelvis
39 4 -1.4862 -84 78 -85 102 IMP:P=1 VOL=4.32E3 IMP:E=1 \$ spine
40 3 -0.9869 -83 86 -50 88 -87 #30 #32 #33 #63 &
#64 #65 IMP:P=1 VOL=5.41E3 IMP:E=1 \$ small int.
41 3 -0.9869 -43 7 -4 #700 IMP:P=1 VOL=1.91E3 IMP:E=1 \$ breast
42 3 -0.9869 -44 7 -4 #700 IMP:P=1 VOL=1.91E3 IMP:E=1 \$ breast
43 3 -0.9869 -92 65 IMP:P=1 VOL=7.06E2 IMP:E=1 \$ kidney
44 3 -0.9869 -93 -94 IMP:P=1 VOL=7.06E2 IMP:E=1 \$ kidney
45 3 -0.9869 -95 IMP:P=1 VOL=1.49E3 IMP:E=1 \$ bladder
46 3 -0.9869 -96 IMP:P=1 VOL=8.70E2 IMP:E=1 \$ spleen
47 3 -0.9869 -98 99 (-65:100) IMP:P=1 VOL=2.99E2 IMP:E=1 \$ pancreas
48 3 -0.9869 -101 IMP:P=1 VOL=1.46E2 IMP:E=1 \$ thymus
49 4 -1.4862 47 -102 #60 #61 IMP:P=1 VOL=4.20E3 IMP:E=1 \$ skull
50 4 -1.4862 -103 708 -37 IMP:P=1 VOL=6.99E3 IMP:E=1 \$ leg bone
51 4 -1.4862 -104 708 -37 IMP:P=1 VOL=6.99E3 IMP:E=1 \$ leg bone
52 3 -0.9869 -105 92 IMP:P=1 VOL=4.81E1 IMP:E=1 \$ adrenal
53 3 -0.9869 -106 93 IMP:P=1 VOL=4.81E1 IMP:E=1 \$ adrenal
54 4 -1.4862 37 -111 -112 IMP:P=1 VOL=2.24E3 IMP:E=1 \$ arm bone
55 4 -1.4862 37 -111 -113 IMP:P=1 VOL=2.24E3 IMP:E=1 \$ arm bone
56 4 -1.4862 4 114 -115 116 -117 -118 &
119 IMP:P=1 VOL=4.78E2 IMP:E=1 \$ scapulae
57 4 -1.4862 4 114 -115 116 -117 -120 &
121 IMP:P=1 VOL=4.78E2 IMP:E=1 \$ scapulae
58 4 -1.4862 -4 -122 -123 124 IMP:P=1 VOL=1.33E2 IMP:E=1 \$ clavicle
59 4 -1.4862 -4 -122 -125 126 IMP:P=1 VOL=1.33E2 IMP:E=1 \$ clavicle
60 3 -0.9869 -33 128 129 -130 133 -134 -4 &
#700 IMP:P=1 VOL=1.20E1 IMP:E=1 \$ eye lense
61 3 -0.9869 -33 128 -131 132 133 -134 -4 &
#700 IMP:P=1 VOL=1.20E1 IMP:E=1 \$ eye lense
62 3 -0.9869 5 -77 -137 IMP:P=1 VOL=2.16E2 IMP:E=1 \$ Oesophagus
63 3 -0.9869 -138 58 -59 IMP:P=1 VOL=4.81E2 IMP:E=1 \$ Ascending Colon Interior
64 3 -0.9869 -139 66 -67 IMP:P=1 VOL=6.31E2 IMP:E=1 \$ Transverse Colon Interior
65 3 -0.9869 61 -140 -59 IMP:P=1 VOL=5.09E2 IMP:E=1 \$ Decending Colon Interior
66 3 -0.9869 (-141 65 -61) : &
(-142 37 -65) IMP:P=1 VOL=1.77E2 IMP:E=1 \$ Sigmoid colon Interior
600 0 -600 35 34 : -601 33 -35 606 : & \$ Head & Neck
-606 6 33 -607 43 44 -4 : &
-607 7 -6 37 43 44 -4 : & \$ Shoulders & Torso
-606 6 33 -607 4 : -38 708 -610 40 : &
-607 7 -6 37 4 : &
-603 43 607 -4 : -604 44 607 -4 : & \$ Breasts
-610 40 -37 38 : -609 39 -37 38 : & \$ Legs
-38 608 -609 : -38 608 -610 : & \$ Feet
-38 708 -609 39 IMP:P=1 VOL=1.37E4 IMP:E=1
700 5 -1.04 707 -706 37 -7 : -6 706 -707 33 : & \$ Body and sholders
701 -33 -35 706 : 700 -34 35 102 : & \$ Head and neck
-43 703 7 -4 : -44 704 7 -4 : 38 -708 -39 : & \$ Breasts
-40 710 -37 38 : -39 709 -37 38 : & \$ Legs
38 -708 -40 IMP:P=1 VOL=1.21E4 IMP:E=1
67 0 1 IMP:P=0 IMP:E=0

1 SO 200
2 SQ 23.04 10.24 1 0 0 0 -508.96 8.0 0 40.9
3 SQ 23.04 10.24 1 0 0 0 -508.96 2.35 0 40.9
4 PY 0.0
5 PZ 40.92
6 PZ 66
606 PZ 66.2
706 PZ 65.8
7 SQ 1 4.0 0 0 0 0 -353.44 0 0 0
607 SQ 0.00277 0.010851 0 0 0 0 -1 0 0 0
707 SQ 0.002891 0.011815 0 0 0 0 -1 0 0 0
8 SQ 1 3.2383 0 0 0 0 -241.18 0 0 0
9 SQ 1 3.0914 0 0 0 0 -256 0 0 0
10 PZ 42.24
11 PZ 33.0
12 PZ 34.32
13 PZ 35.64
14 PZ 36.96
15 PZ 38.28
16 PZ 39.60
17 PZ 43.56
18 PZ 44.88
19 PZ 46.20
20 PZ 47.52
21 PZ 48.84
22 PZ 50.16
23 PZ 51.48
24 PZ 52.80
25 PZ 54.12
26 PZ 55.44
27 PZ 56.76
28 PZ 58.08
29 PZ 59.40
30 PZ 60.72
31 PZ 62.04
32 PZ 63.36
33 SQ 88.36 43.56 0 0 0 0 -3848.96 0 0 0
701 SQ 0.024414 0.011815 0 0 0 0 -1 0 0 0
601 SQ 0.021626 0.010851 0 0 0 0 -1 0 0 0
34 SQ 5941.33 2928.97 3848.96 0 0 0 -258804.18 0 0 80.8
700 SQ 0.024414 0.011815 0.015625 0 0 0 -1 0 0 80.8
600 SQ 0.021626 0.010851 0.014172 0 0 0 -1 0 0 80.8
35 PZ 80.8
36 PZ 94
37 PZ 0
38 PZ -75
708 PZ -74.8
608 PZ -75.2
39 601 GQ 5 5 0 0 0 -1 -93.5 0 0 0
709 601 GQ 5 5 0 0 0 -1 -92.5 0 0 0
609 GQ 5 5 0 0 0 -1 -95 0 0 0
40 600 GQ 5 5 0 0 0 1 93.5 0 0 0
710 600 GQ 5 5 0 0 0 1 92.5 0 0 0
610 GQ 5 5 0 0 0 1 95 0 0 0
41 SQ 23.04 10.24 1 0 0 0 -508.96 -8.0 0 40.9

42 SQ 23.04 10.24 1 0 0 0 -508.96 -2.35 0 40.9
 43 SQ 1.39 .5 2 0 0 0 -70 -7 -3 47
 703 SQ 0.021004 0.007432 0.030779 0 0 0 -1 -7 -3 47
 603 SQ 0.018765 0.006944 0.026874 0 0 0 -1 -7 -3 47
 44 SQ 1.39 .5 2 0 0 0 -70 7 -3 47
 704 SQ 0.021004 0.007432 0.030779 0 0 0 -1 7 -3 47
 604 SQ 0.018765 0.006944 0.026874 0 0 0 -1 7 -3 47
 45 PY -4.88
 46 SQ 3.4294 1 9.7656 0 0 0 -25 0 -1.88 13.16
 47 SQ 2.2367 1 1.8878 0 0 0 -71.4025 0 0 81.8
 48 SQ 56.55 234.396 0 0 0 0 -13255.193 0 0 0
 49 P 9 7 -7.3256 -296.1
 50 PZ 25.38
 51 PZ 40.42
 52 GQ 39.9 52.9 42.3 15.5 -14.3 30.8 -1355.8 1000.7 -4068.3 97042.9
 53 SQ 1 1 1 0 0 0 -22.09 -.94 -2.82 47.94
 54 P .6943 -.3237 -.6428 -30.56
 55 P 4.9061 -2.2876 -0.861 -52.693
 56 SQ 4 7.11 1 0 0 0 -56.55 7.71 -4.04 33.09
 57 SQ 1 1 0 0 0 0 -5.5225 -8. -2.22 0
 58 PZ 13.60
 59 PZ 22.56
 60 GQ 4.01 3.12 .0963 0 1.088 -0.156 -64.21 -8.93 -.303 251.015
 61 PZ 8.21
 62 SQ 0 1.9881 5.5225 0 0 0 -10.97928 0 -2.22 23.97
 63 TY 2.82 0 8.21 5.39 1.47 1.47
 64 TY 2.82 0 0 2.82 1.47 1.47
 65 PX 2.82
 66 PX -9.87
 67 PX 9.87
 68 PX -20
 69 PX 20
 70 PY -30
 71 PY -29
 72 SQ 3.3058 11.11 1 0 0 0 -4 5.3 0 13.8
 73 SQ 3.31 11.11 1 0 0 0 -4 -5.3 0 13.8
 74 C/Z 0 -5.64 2.07
 75 C/Z 0 -5.64 0.94
 76 PY -5.64
 77 PZ 70.7
 78 PZ 20.68
 79 PZ 13.16
 80 PY -2.82
 81 PY 4.70
 82 C/Z 0 -2.82 11.28
 83 C/Z 0 -3.57 10.62
 84 SQ 7.07 4.53 0 0 0 0 -25 0 5.17 0
 85 PZ 73.8
 86 PZ 15.98
 87 PY 2.07
 88 PY -4.70
 89 C/Z 0 -10.3 0.6350
 90 C/Z 0 -10.3 0.8636
 91 PZ 53.76
 92 SQ 1.4938 13.4444 1 0 0 0 -26.73 5.64 5.64 30.55
 93 SQ 1.4938 13.4444 1 0 0 0 -26.73 -5.64 5.64 30.55

94 PX -2.82
 95 SQ 1 2.0557 2.0557 0 0 0 -24.5818 0 -4.23 7.52
 96 SQ 2.94 9 1 0 0 0 -31.81 10.34 2.82 34.78
 97 PZ 11
 98 SQ 1 225 25 0 0 0 -198.81 0 0 34.78
 99 PX 0
 100 PZ 34.78
 101 SQ 1.78 64 1 0 0 0 -16 -2 -6 59.0
 102 SQ 2.07 1 1.32 0 0 0 -84.64 0 0 80.8
 103 GQ 1 1 .009 0 0 -.2 -18.8 0 1.674 77.536
 104 GQ 1 1 .009 0 0 .2 18.8 0 1.674 77.536
 105 SQ 4.88 43.92 0.44 0 0 0 -9.70 4.23 6.11 35.72
 106 SQ 4.88 43.92 0.44 0 0 0 -9.70 -4.23 6.11 35.72
 107 PX 16
 108 PX 5
 109 PX -5
 110 PX -16
 111 PZ 65
 112 GQ .6944 .1550 0 0 0 .0128 -24.8611 0 -.2372 222.2569
 113 GQ .6944 .1550 0 0 0 -.0128 24.8611 0 -.2372 222.2569
 114 SQ 1 3.0246 0 0 0 0 -256 0 0 0
 115 SQ 1 3.7687 0 0 0 0 -318.98 0 0 0
 116 PZ 47.85
 117 PZ 63.26
 118 P 0.25 -1 0 0
 119 P 0.8 -1 0 0
 120 P -0.25 -1 0 0
 121 P -0.8 -1 0 0
 122 TZ 0 10.43 64.16 18.8 0.7410 0.7410
 123 P 0.89415 1 0 10.43
 124 P 7.0342 1 0 10.43
 125 P -0.89415 1 0 10.43
 126 P -7.0342 1 0 10.43
 C 2 concentric elliptical cylinders and planes to define eye lenses
 127 SQ 100 64 0 0 0 0 -6400 0 0 0
 128 SQ 77.44 36 0 0 0 0 -2787.87 0 0 0
 129 PX 2
 130 PX 4
 131 PX -2
 132 PX -4
 133 PZ 78.0
 134 PZ 80.0
 C segmenting planes for RBM regions in leg and arm bones
 135 PZ -21.375
 136 PZ 49.55
 C Oesophagus
 137 SQ 0.16 1.0 0 0 0 0 -0.16 0.5 2.4 0
 C Colon Wall
 138 SQ 1 1 0 0 0 0 -2.839225 -8.0 -2.22 0
 139 SQ 0 0.837225 3.441025 0 0 0 -2.880912156 0 -2.36 23.97
 140 GQ 1.651 2.235 0.0685 0 0.779 -0.064 -26.45 -6.39 -0.598 106.82
 141 TY 2.82 0 8.21 5.39 0.85 0.85
 142 TY 2.82 0 0 2.82 0.85 0.85

TR600 -0.1
 TR601 0.1

C

C Source Cards

SDEF PAR=2 ERG=D1 CEL=600 POS 0 0 -80.5

RAD=D3 EXT=D4 EFF=1E-4 AXS 0 0 1

SI1 L 0.0595 0.0139 0.0178 0.0168 0.0208 0.0138

0.0263 0.0171 0.018 0.0175

SP1 0.357 0.219 0.188 0.0582 0.0457 0.0245

0.024 0.0222 0.0196 0.0126

SI3 0 20.21

SP3 -21 1

SI4 0 174.75

SP4 -21 0

C

C Tally Cards

C Tally Cards

*F8:P 35 36 T

FC8 Gonad Gamma Dose

*F18:E 35 36 T

FC18 Gonad Electron Dose

*F28:P 37

FC28 Thyroid Gamma Dose

*F38:E 37

FC38 Thyroid Electron Dose

*F48:P 9 10 11 12 13 14 15 16 17 18 19 20 38 39 49

50 51 54 55 56 57 58 59 T

FC48 Bone Gamma Dose

*F58:E 9 10 11 12 13 14 15 16 17 18 19 20 38 39 49

50 51 54 55 56 57 58 59 T

FC58 Bone Electron Dose

*F68:P 2 24 T

FC68 Lung Gamma Dose

*F78:E 2 24 T

FC78 Lung Electron Dose

*F88:P 29

FC88 Stomach Gamma Dose

*F98:E 29

FC98 Stomach Electron Dose

*F108:P 30 31 32 33 63 64 65 66

FC108 Colon Gamma Dose

*F118:E 30 31 32 33 63 64 65 66

FC118 Colon Electron Dose

*F128:P 45

FC128 Bladder Gamma Dose

*F138:E 45

FC138 Bladder Electron Dose

*F148:P 27

FC148 Liver Gamma Dose

*F158:E 27

FC158 Liver Electron Dose

*F168:P 62

FC168 Oesophagus Gamma Dose

*F178:E 62

FC178 Oesophagus Electron Dose

*F188:P 700

FC188 Skin Gamma Dose

*F198:E 700

FC198 Skin Electron Dose

*F228:P 41 42

FC228 Breast Gamma Dose

*F238:E 41 42

FC238 Breast Electron Dose

C

C Material Cards

C THIS IS THE COMPOSITION FOR AIR

M1 7014 -.7558 8016 -.2314 18000 -.0128

C THIS IS THE COMPOSITION FOR LUNG TISSUE

M2 1001 -.1021

6012 -.1001

7014 -.0280

8016 -.7596

11023 -.0019

15031 -.0008

16032 -.0023

17000 -.0027

19000 -.0020

20000 -.0001

26000 -.0004

C THE COMPOSITION FOR TOTAL BODY MINUS SKELETON AND LUNGS

M3 1001 -.1047

6012 -.2302

7014 -.0234

8016 -.6321

11023 -.0013

12000 -.0002

15031 -.0024

16032 -.0022

17000 -.0014

19000 -.0021

C THE COMPOSITION FOR SKELETAL TISSUE

M4 1001 -.0704

6012 -.2279

8016 -.4856

7014 -.0387

11023 -.0032

12000 -.0011

15031 -.0694

16032 -.0017

17000 -.0014

19000 -.0015

20000 -.0991

c Adult Tissues (Density = 1.04 g/cc)

M5 1001 -0.10454

6012 -0.22663

7014 -0.02490

8016 -0.63525

11023 -0.00112

12000 -0.00013

14000 -0.00030

15031 -0.00134

16032 -0.00204

17000 -0.00133

19000 -0.00208

20000 -0.00024
26000 -0.00005
30000 -0.00003
37085 -0.000007217
37087 -0.000002783
40000 -0.00001

C

NPS 1E8

RAND GEN=2 SEED=1561615651

phys:p 4J 1

PRINT

MODE P E

APPENDIX E

ADIPOSE MALE INPUT FILE

Adipose Male patient

C Cs-137 Skin Source

```
1 1 -0.001293 -1 (603:-609:602) (-602:601:35) (600:-35) 604 605
    (609:-612:610) (609:-612:611) (606:4:-609)
    (-607:609:-43:44:4:-608) #600 IMP:P=1 IMP:E=1
2 2 -0.2958 ((-2 -4 3):(-2 4)) 5 IMP:P=1 IMP:E=1 VOL=9.90E3 $ left lung
3 3 -0.9869 -7 51 -6 (-8:32) 84 101 #2 #24 #28 #58
    (113:115) (114:115) # 59 #62 #700
    IMP:P=1 IMP:E=1 VOL=5.38E4 $ torso
4 3 -0.9869 -7 8 -32 117 113 114 #15 #16 #17 #18 #19
    (-4:-9:116:118:-119) (-4:-9:116:120:-121)
    #20 #700 IMP:P=1 IMP:E=1 VOL=2.70E4 $ torso
5 3 -0.9869 -7 8 -117 51 113 114 #9 #13 #14 #700
    IMP:P=1 IMP:E=1 VOL=1.40E4 $ torso
6 3 -0.9869 -7 50 -51 56 84 96 105 106 113 114 #10
    #11 #12 #27 #32 #43 #44 #47 #700
    IMP:P=1 IMP:E=1 VOL=5.75E4 $ torso
7 3 -0.9869 -7 97 -50 (83:-86:87:-88) 113 114 #30
    #33 #38 #39 #63 #64 #65 #700
    IMP:P=1 IMP:E=1 VOL=6.06E4 $ torso abdoman
8 3 -0.9869 -7 37 -97 95 113 114 #31 #33 #38 #65
    #66 #700 IMP:P=1 IMP:E=1 VOL=5.50E4 $ torso
9 4 -1.4862 8 -9 5 -10 IMP:P=1 IMP:E=1 VOL=3.43E2 $ rib
10 4 -1.4862 8 -9 11 -12 IMP:P=1 IMP:E=1 VOL=3.43E2 $ rib
11 4 -1.4862 8 -9 13 -14 IMP:P=1 IMP:E=1 VOL=3.43E2 $ rib
12 4 -1.4862 8 -9 15 -16 IMP:P=1 IMP:E=1 VOL=3.43E2 $ rib
13 4 -1.4862 8 -9 17 -18 IMP:P=1 IMP:E=1 VOL=3.43E2 $ rib
14 4 -1.4862 8 -9 19 -20 IMP:P=1 IMP:E=1 VOL=3.43E2 $ rib
15 4 -1.4862 8 -9 21 -22 IMP:P=1 IMP:E=1 VOL=3.43E2 $ rib
16 4 -1.4862 8 -9 23 -24 IMP:P=1 IMP:E=1 VOL=3.43E2 $ rib
17 4 -1.4862 8 -9 25 -26 IMP:P=1 IMP:E=1 VOL=3.43E2 $ rib
18 4 -1.4862 8 -9 27 -28 IMP:P=1 IMP:E=1 VOL=3.43E2 $ rib
19 4 -1.4862 8 -9 29 -30 IMP:P=1 IMP:E=1 VOL=3.43E2 $ rib
20 4 -1.4862 8 -9 31 -32 IMP:P=1 IMP:E=1 VOL=3.43E2 $ rib
21 3 -0.9869 ((35 -34):(-33 6 -35)) 102 (84:85) #37 #60
    #61 #62 #700 IMP:P=1 IMP:E=1 VOL=1.09E4 $ head
22 3 -0.9869 -37 38 -39 103 #700 IMP:P=1
    IMP:E=1 VOL=5.01E4 $ left leg
23 3 -0.9869 -37 38 -40 104 # 22 #700 IMP:P=1
    IMP:E=1 VOL=5.01E4 $ right leg
24 2 -0.2958 ((-41 -4 42):(-41 4)) 5
    IMP:P=1 IMP:E=1 VOL=9.88E3 $ right lung
25 3 -0.9869 45 -37 43 -44 -4 46 39 40 72 73
    #700 IMP:P=1 IMP:E=1 VOL=8.08E2 $ genitalia
26 3 -0.9869 -47 IMP:P=1 IMP:E=1 VOL=8.25E3 $ brain
27 3 -0.9869 50 -51 -48 -49 #10 #11 #12 IMP:P=1
    IMP:E=1 VOL=1.09E4 $ liver
28 3 -0.9869 (-52 54) : (-53 -54 55)
```

IMP:P=1 IMP:E=1 VOL=3.49E3 \$ heart
 29 3 -0.9869 -56 IMP:P=1 IMP:E=1 VOL=2.39E3 \$ stomach
 30 3 -0.9869 138 -57 58 -59 IMP:P=1 IMP:E=1 VOL=5.47E2 \$ Ascending Colon Wall
 31 3 -0.9869 (-63 141 65 -61) : (-64 142 37 -65)
 IMP:P=1 IMP:E=1 VOL=4.20E2 \$ Sigmoid Wall
 32 3 -0.9869 -62 139 66 -67 59 IMP:P=1 IMP:E=1 VOL=7.22E2 \$ Transverse Colon Wall
 33 3 -0.9869 -60 140 61 -59 -83 IMP:P=1 IMP:E=1 VOL=5.23E2 \$ Descending Colon Wall
 35 3 -0.9869 -72 IMP:P=1 IMP:E=1 VOL=1.11E2 \$ testicle
 36 3 -0.9869 -73 IMP:P=1 IMP:E=1 VOL=1.11E2 \$ testicle
 37 3 -0.9869 -74 75 -76 6 -77 IMP:P=1 IMP:E=1 VOL=1.72E2 \$ thyroid
 38 4 -1.4862 -82 83 37 -78 80
 (79 : -81) IMP:P=1 IMP:E=1 VOL=3.63E3 \$ pelvis
 39 4 -1.4862 -84 78 -85 102 IMP:P=1 IMP:E=1 VOL=5.17E3 \$ spine
 40 3 -0.9869 -83 86 -50 88 -87 #30 #32 #33 #63
 #64 #65 IMP:P=1 IMP:E=1 VOL=6.31E3 \$ small int.
 41 3 -0.9869 -107 7 -4 #700 IMP:P=1 IMP:E=1 VOL=1.07E3 \$ breast
 42 3 -0.9869 -108 7 -4 #700 IMP:P=1 IMP:E=1 VOL=1.07E3 \$ breast
 43 3 -0.9869 -92 65 IMP:P=1 IMP:E=1 VOL=8.55E2 \$ kidney
 44 3 -0.9869 -93 -94 IMP:P=1 IMP:E=1 VOL=8.55E2 \$ kidney
 45 3 -0.9869 -95 IMP:P=1 IMP:E=1 VOL=1.49E3 \$ bladder
 46 3 -0.9869 -96 IMP:P=1 IMP:E=1 VOL=1.05E3 \$ spleen
 47 3 -0.9869 -98 99 (-65:100) IMP:P=1 IMP:E=1 VOL=3.59E2 \$ pancreas
 48 3 -0.9869 -101 IMP:P=1 IMP:E=1 VOL=1.45E2 \$ thymus
 49 4 -1.4862 47 -102 #60 #61 IMP:P=1 IMP:E=1 VOL=4.78E3 \$ skull
 50 4 -1.4862 -103 712 -37 IMP:P=1 IMP:E=1 VOL=8.25E3 \$ leg bone
 51 4 -1.4862 -104 712 -37 IMP:P=1 IMP:E=1 VOL=8.25E3 \$ leg bone
 52 3 -0.9869 -105 92 IMP:P=1 IMP:E=1 VOL=5.81E1 \$ adrenal
 53 3 -0.9869 -106 93 IMP:P=1 IMP:E=1 VOL=5.81E1 \$ adrenal
 54 4 -1.4862 37 -115 -113 IMP:P=1 IMP:E=1 VOL=2.81E3 \$ arm bone
 55 4 -1.4862 37 -115 -114 IMP:P=1 IMP:E=1 VOL=2.81E3 \$ arm bone
 56 4 -1.4862 4 9 -32 -116 117 -118 119
 IMP:P=1 IMP:E=1 VOL=5.90E2 \$ scapulae
 57 4 -1.4862 4 9 -32 -116 117 -120 121
 IMP:P=1 IMP:E=1 VOL=5.90E2 \$ scapulae
 58 4 -1.4862 -4 -122 -123 124 IMP:P=1 IMP:E=1 VOL=1.56E2 \$ clavicle
 59 4 -1.4862 -4 -122 -125 126 IMP:P=1 IMP:E=1 VOL=1.56E2 \$ clavicle
 60 3 -0.9869 -33 128 129 -130 133 -134 -4 #700
 IMP:P=1 IMP:E=1 VOL=1.11E1 \$ eye lense
 61 3 -0.9869 -33 128 -131 132 133 -134 -4 #700
 IMP:P=1 IMP:E=1 VOL=1.11E1 \$ eye lense
 62 3 -0.9869 -77 -137 51 IMP:P=1 IMP:E=1 VOL=2.32E2 \$ oesophagus
 63 3 -0.9869 -138 58 -59 IMP:P=1 IMP:E=1 VOL=5.78E2 \$ Ascending Colon Interior
 64 3 -0.9869 -139 66 -67 IMP:P=1 IMP:E=1 VOL=7.58E2 \$ Transvers Colon Interior
 65 3 -0.9869 -140 61 -59 -83 IMP:P=1 IMP:E=1
 VOL=6.15E2 \$ Decending Colon Interior
 66 3 -0.9869 (-141 65 -61) : (-142 37 -65)
 IMP:P=1 IMP:E=1 VOL=2.16E2 \$ Sigmoid Interior
 67 3 -0.9869 -143 7 -4 #700 IMP:P=1 IMP:E=1
 VOL=4.10E4 \$ Abdoman-Adipose
 600 0 -600 34 35 : -35 -601 602 33 : &
 -6 37 606 605 604 7 -603 : 108 -605 7 : &
 107 -604 7: 143 -606 7: &
 -611 -607 38 39 40 : -602 6 33 -603 : &
 -610 611 -607 38 39 : &
 -38 612 -610 : -38 612 -611 : &
 -37 609 -603 4 39 40: -37 609 -4 -603 40 -43: &

-37 609 -4 -603 39 44: -37 609 -603 43 -44 -46: &
 -609 607 4 -611 39 40 : -609 607 4 -610 39 611 : &
 -609 45 -43 -611 40: -609 45 44 -610 39 : &
 -609 45 43 -44 608 -46: -45 607 -4 608 39 &
 40 43 -44 : -4 -45 607 -43 -611 40 : &
 -4 -45 607 44 -610 39 IMP:P=1 IMP:E=1 VOL=1.91E4
 700 5 -1.04 -34 102 35: -35 6 701 -33: -6 702 -7 701: &
 -6 37 -7 703 706 704 705: -143 706 7 -87: &
 -108 705 7 -87: -37 38 -39 710: -37 38 -40 711: &
 -107 704 7 -87: -37 45 46 &
 -708 -44 43: -44 43 39 40 -707 45 708 -4: &
 -712 38 -39 : 38 -712 -40 IMP:P=1 IMP:E=1 VOL=1.89E4
 71 0 1 IMP:P=0 IMP:E=0

C Surface Cards

1 RPP -22.302 22.302 -24.401 12.302 -80.417 94.202
 2 SQ 23.04 10.24 1 0 0 0 -576 8.5 0 43.5
 3 SQ 23.04 10.24 1 0 0 0 -576 2.5 0 43.5
 4 PY 0.0
 5 PZ 43.5
 6 PZ 70
 702 PZ 69.8
 602 PZ 70.2
 7 SQ 1 3.3359 0 0 0 0 -488.41 0 0 0
 703 SQ 141.6102597 479.61 0 0 0 0 -67917.69667 0 0 0
 603 SQ 151.2902685 497.29 0 0 0 0 -75235.1376 0 0 0
 8 SQ 1 3.15 0 0 0 0 -272.25 0 0 0
 9 SQ 1 3.01 0 0 0 0 -289.0 0 0 0
 10 PZ 44.9
 11 PZ 35.1
 12 PZ 36.5
 13 PZ 37.9
 14 PZ 39.3
 15 PZ 40.7
 16 PZ 42.1
 17 PZ 46.3
 18 PZ 47.7
 19 PZ 49.1
 20 PZ 50.5
 21 PZ 51.9
 22 PZ 53.3
 23 PZ 54.7
 24 PZ 56.1
 25 PZ 57.5
 26 PZ 58.9
 27 PZ 60.3
 28 PZ 61.7
 29 PZ 63.1
 30 PZ 64.5
 31 PZ 65.9
 32 PZ 67.3
 33 SQ 100 49 0 0 0 0 -4900 0 0 0
 701 SQ 96.04 46.24 0 0 0 0 -4440.8896 0 0 0
 601 SQ 104.04 51.84 0 0 0 0 -5393.4336 0 0 0
 34 SQ 7225 3540.25 4900 0 0 0 -354025 0 0 85.5
 700 SQ 6616.1956 3185.4736 4440.8896 0 0 0 -305932.8845 0 0 85.5

600 SQ 7874.7876 3923.7696 5393.4336 0 0 0 -408228.9892 0 0 85.5
35 PZ 85.5
36 PZ 94
37 PZ 0
609 PZ -0.2
38 PZ -80
612 PZ -80.2
712 PZ -79.8
39 GQ 5 5 0 0 0 -1 -100 0 0 0
710 601 GQ 5 5 0 0 0 -1 -98 0 0 0
610 600 GQ 5 5 0 0 0 -1 -102 0 0 0
40 GQ 5 5 0 0 0 1 100 0 0 0
711 600 GQ 5 5 0 0 0 1 98 0 0 0
611 601 GQ 5 5 0 0 0 1 102 0 0 0
41 SQ 23.04 10.24 1 0 0 0 -576 -8.5 0 43.5
42 SQ 23.04 10.24 1 0 0 0 -576 -2.5 0 43.5
43 P 10 0 1 -100
44 P 10 0 -1 100
45 PZ -4.8
707 pz -4.6
607 PZ -5.0
46 P 0 10 1 -100
708 702 P 0 10 1 -100
608 602 P 0 10 1 -100
47 SQ 2.25 1 1.91716 0 0 0 -81 0 0 86.5
48 SQ 64 272.25 0 0 0 0 -17424 0 0 0
49 P 9 7 -7.3256 -315
50 PZ 27
51 PZ 43
52 GQ 45.2 59.9 47.9 17.5 -16.2 34.8 -1632.1 1204.8 -4898.2 124295.2
53 SQ 1 1 1 0 0 0 -25 -1 -3 51
54 P .6943 -.3237 -.6428 -32.506
55 P 5.2193 -2.4336 -0.916 -59.6345
56 SQ 4 7.11 1 0 0 0 -64 8 -4 35
57 SQ 1 1 0 0 0 0 -6.25 -8.5 -2.36 0
58 PZ 14.45
59 PZ 24
60 GQ 4.54 3.53 .096 0 1.16 -0.166 -77.68 -10.08 -.223 323.52
61 PZ 8.72
62 SQ 0 2.25 6.25 0 0 0 -14.0625 0 -2.36 25.5
63 TY 3 0 8.72 5.72 1.57 1.57
64 TY 3 0 0 3 1.57 1.57
65 PX 3
66 PX -10.5
67 PX 10.5
68 PX -22.1
69 PX 22.1
70 PY -30
71 PY -29
72 SQ 11.9025 8.9401 3.8025 0 0 0 -20.115225 1.3 -8 -2.3
73 SQ 11.9025 8.9401 3.8025 0 0 0 -20.115225 -1.3 -8 -2.3
74 C/Z 0 -6 2.2
75 C/Z 0 -6 1
76 PY -6
77 PZ 75
78 PZ 22

79 PZ 14
80 PY -3
81 PY 5
82 C/Z 0 -3 12
83 C/Z 0 -3.8 11.3
84 SQ 6.25 4 0 0 0 0 -25 0 5.5 0
85 PZ 78.5
86 PZ 17
87 PY 2.2
88 PY -4.86
89 C/Z 0 -11. 0.6350
90 C/Z 0 -11. 0.8636
91 PZ 56.335
92 SQ 1.49 13.44 1 0 0 0 -30.25 6 6 32.5
93 SQ 1.49 13.44 1 0 0 0 -30.25 -6 6 32.5
94 PX -3
95 SQ 1 2.0557 2.0557 0 0 0 -24.5818 0 -4.5 8
96 SQ 2.94 9 1 0 0 0 -36 11 3 37
97 PZ 12
98 SQ 1 225 25 0 0 0 -225 0 0 37
99 PX 0
100 PZ 37
101 SQ 1.78 64 1 0 0 0 -16 -2 -6 60.5
102 SQ 2.08 1 1.39 0 0 0 -96.04 0 0 85.5
103 GQ 1 1 .0091 0 0 -.2005 -20 0 1.7857 87.75
104 GQ 1 1 .0091 0 0 .2005 20 0 1.7857 87.75
105 SQ 100 900 9 0 0 0 -225 4.5 6.5 38
106 SQ 100 900 9 0 0 0 -225 -4.5 6.5 38
107 SQ 0.5624 0.62316 1.60473 0 0 0 -56.24 -7.5 -5 50
704 SQ 2829.804157 3142.274588 8306.470934 0 0 0 -271774.3912 -7.5 -5 50
604 SQ 3524.072262 3896.755141 9789.091211 0 0 0 -366644.4781 -7.5 -5 50
108 SQ 0.5624 0.62316 1.60473 0 0 0 -56.24 7.5 -5 50
705 SQ 2829.804157 3142.274588 8306.470934 0 0 0 -271774.3912 7.5 -5 50
605 SQ 3524.072262 3896.755141 9789.091211 0 0 0 -366644.4781 7.5 -5 50
109 PX 17
110 PX 6
111 PX -6
112 PX -17
113 GQ 503.01 135.24 0 0 0 10.206 -19215 0 -202.0788 183257
114 GQ 503.01 135.24 0 0 0 -10.206 19215 0 -202.0788 183257
115 PZ 69
116 SQ 1 3.7589 0 0 0 0 -361 0 0 0
117 PZ 50.9
118 P 0.25 -1 0 0
119 P 0.8 -1 0 0
120 P -0.25 -1 0 0
121 P -0.8 -1 0 0
122 TZ 0 11.1 68.25 20 0.7883 0.7883
123 P 0.89415 1 0 11.1
124 P 7.0342 1 0 11.1
125 P -0.89415 1 0 11.1
126 P -7.0342 1 0 11.1
C 2 concentric elliptical cylinders and planes to define eye lenses
127 SQ 100 64 0 0 0 0 -6400 0 0 0
128 SQ 88.36 40.96 0 0 0 0 -3619.2256 0 0 0
129 PX 2

130 PX 4
 131 PX -2
 132 PX -4
 133 PZ 82.5
 134 PZ 84.5
 C segmenting planes for RBM regions in leg and arm bones
 135 PZ -22.8
 136 PZ 52.6
 C Oesophagus
 137 SQ 0.16 1.0 0 0 0 0 -0.16 0.5 2.5 0
 C Colon Wall
 138 SQ 1 1 0 0 0 0 -3.209 -8.5 -2.36 0
 139 SQ 0 0.9467 3.8927 0 0 0 -3.6854 0 -2.36 25.5
 140 GQ 1.796 2.496 0.0674 0 0.818 -0.066 -30.75 -7.12 -0.602 132.2
 141 TY 3 0 8.72 5.72 0.91 0.91
 142 TY 3 0 0 3 0.91 0.91
 C Abdomen Adipose
 143 SQ 1 1.06575 1 0 0 0 -308 0 -7.1 17.55
 706 SQ 84959.40437 90613.05755 84959.40437 0 0 0 -25574482.32 0 -7.1 17.55
 606 SQ 93206.81855 99262.78565 93206.81855 0 0 0 -29365737.6 0 -7.1 17.55

C Data Cards

C Transformation Cards

TR600 -0.2
 TR601 0.2
 TR602 0 -0.2009
 TR702 0 0.2009

C

C Source Cards

SDEF PAR=2 ERG=D1 CEL=600 POS 0 0 -80.5

RAD=D3 EXT=D4 EFF=1E-4 AXS 0 0 1

SI1 L 0.662 0.0332 0.0318

SP1 0.898 0.0392 0.0213

SI3 0 20.21

SP3 -21 1

SI4 0 174.75

SP4 -21 0

C

C Material Cards

C THIS IS THE COMPOSITION FOR AIR

M1 7014 -.7558 8016 -.2314 18000 -.0128

C THIS IS THE COMPOSITION FOR LUNG TISSUE

M2 1001 -.1021

6012 -.1001

7014 -.0280

8016 -.7596

11023 -.0019

15031 -.0008

16032 -.0023

17000 -.0027

19000 -.0020

20000 -.0001

26000 -.0004

C THE COMPOSITION FOR TOTAL BODY MINUS SKELETON AND LUNGS

M3 1001 -.1047

6012 -.2302

7014 -.0234
8016 -.6321
11023 -.0013
12000 -.0002
15031 -.0024
16032 -.0022
17000 -.0014
19000 -.0021

C THE COMPOSITION FOR SKELETAL TISSUE

M4 1001 -.0704

6012 -.2279
8016 -.4856
7014 -.0387
11023 -.0032
12000 -.0011
15031 -.0694
16032 -.0017
17000 -.0014
19000 -.0015
20000 -.0991

c Adult Tissues (Density = 1.04 g/cc)

M5 1001 -0.10454

6012 -0.22663
7014 -0.02490
8016 -0.63525
11023 -0.00112
12000 -0.00013
14000 -0.00030
15031 -0.00134
16032 -0.00204
17000 -0.00133
19000 -0.00208
20000 -0.00024
26000 -0.00005
30000 -0.00003
37085 -0.000007217
37087 -0.000002783
40000 -0.00001

C

C Tally Cards

*F8:P 35 36 T

FC8 Gonad Gamma Dose

*F28:P 37

FC28 Thyroid Gamma Dose

*F48:P 9 10 11 12 13 14 15 16 17 18 19 20 38 39 49

50 51 54 55 56 57 58 59 T

FC48 Bone Gamma Dose

*F68:P 2 24 T

FC68 Lung Gamma Dose

*F88:P 29

FC88 Stomach Gamma Dose

*F108:P 30 31 32 33 63 64 65 66

FC108 Colon Gamma Dose

*F128:P 45

FC128 Bladder Gamma Dose

*F148:P 27

FC148 Liver Gamma Dose
*F168:P 62
FC168 Oesophagus Gamma Dose
*F188:P 700
FC188 Skin Gamma Dose
*F208:P 26 28 40 43 44 46 47 48 52 53 25 T
FC208 Other Gamma Dose
*F218:P 41 42 T
FC218 Breasts Gamma Dose
C
NPS 1.5E8
RAND GEN=2 SEED=1561615651
PHYS:P 4J 1
PRINT
MODE P E

APPENDIX F

ADIPOSE FEMALE INPUT FILE

Adipose Female patient

C I-131 External Source

```

1  1 -0.001293  -1 (607:-37:606) (-606:601:35) (600:-35)
      (37:-608:609) (37:-608:610) (613:4:-37)
      (603:4) (604:4) IMP:P=1 IMP:E=1
2  2 -0.2958  ((-2 -4 3):(-2 4)) 5 IMP:P=1 IMP:E=1 VOL=8.22E3      $ left lung
3  3 -0.9869  -7 5 -6 (-8:32) 84 101 #2 #24 #28 #54 #55
      #58 #59 #62 #700 IMP:P=1 IMP:E=1 VOL=4.11E4
4  3 -0.9869  -7 8 -32 116 112 113 #15 #16 #17 #18 #19
      #20 #56 #57 IMP:P=1 IMP:E=1 VOL=7.92E3
5  3 -0.9869  -7 8 -116 5 112 113 #9 #13 #14
      IMP:P=1 IMP:E=1 VOL=4.05E3  $ torso
6  3 -0.9869  -7 50 -5 56 84 96 105 106 112 113 #10 #11 #12
      #27 #43 #44 #47 IMP:P=1 IMP:E=1 VOL=3.45E4      $ torso
7  3 -0.9869  -7 97 -50 (83:-86:87:-88)72 73 112 113 #25
      #30 #33 #38 #39 #43 #44 #63 #64 #65
      IMP:P=1 IMP:E=1 VOL=3.58E4
8  3 -0.9869  -7 37 -97 95 112 113 #31 #33 #38 #65
      #66 IMP:P=1 IMP:E=1 VOL=3.29E4  $ torso
9  4 -1.4862  8 -9 5 -10 IMP:P=1 IMP:E=1 VOL=2.83E2      $ rib
10 4 -1.4862  8 -9 11 -12 IMP:P=1 IMP:E=1 VOL=2.83E2      $ rib
11 4 -1.4862  8 -9 13 -14 IMP:P=1 IMP:E=1 VOL=2.83E2      $ rib
12 4 -1.4862  8 -9 15 -16 IMP:P=1 IMP:E=1 VOL=2.83E2      $ rib
13 4 -1.4862  8 -9 17 -18 IMP:P=1 IMP:E=1 VOL=2.83E2      $ rib
14 4 -1.4862  8 -9 19 -20 IMP:P=1 IMP:E=1 VOL=2.83E2      $ rib
15 4 -1.4862  8 -9 21 -22 IMP:P=1 IMP:E=1 VOL=2.83E2      $ rib
16 4 -1.4862  8 -9 23 -24 IMP:P=1 IMP:E=1 VOL=2.83E2      $ rib
17 4 -1.4862  8 -9 25 -26 IMP:P=1 IMP:E=1 VOL=2.83E2      $ rib
18 4 -1.4862  8 -9 27 -28 IMP:P=1 IMP:E=1 VOL=2.83E2      $ rib
19 4 -1.4862  8 -9 29 -30 IMP:P=1 IMP:E=1 VOL=2.83E2      $ rib
20 4 -1.4862  8 -9 31 -32 IMP:P=1 IMP:E=1 VOL=2.83E2      $ rib
21 3 -0.9869  ((35 -34):(-33 6 -35)) 102 (84:85) #37 #60
      #61 #62 #700 IMP:P=1 IMP:E=1 VOL=9.24E3      $ head
22 3 -0.9869  -37 38 -39 103 #700 IMP:P=1 IMP:E=1
      VOL=4.38E4      $ left leg
23 3 -0.9869  -37 38 -40 104 #700 IMP:P=1 IMP:E=1
      VOL=4.38E4      $ right leg
24 2 -0.2958  ((-41 -4 42):(-41 4))
      5 IMP:P=1 IMP:E=1 VOL=8.22E3      $ right lung
25 3 -0.9869  45 -46 IMP:P=1 IMP:E=1 VOL=4.89E2      $ uterus
26 3 -0.9869  -47 IMP:P=1 IMP:E=1 VOL=6.97E3      $ brain
27 3 -0.9869  50 -51 -48 -49 IMP:P=1 IMP:E=1 VOL=8.84E3      $ liver
28 3 -0.9869  (-52 54):(-53 -54 55) IMP:P=1 IMP:E=1
      VOL=3.01E3      $ heart
29 3 -0.9869  -56 IMP:P=1 IMP:E=1 VOL=1.99E3      $ stomach
30 3 -0.9869  -57 138 58 -59 IMP:P=1 IMP:E=1 VOL=4.53E2      $ Ascending Colon Wall
31 3 -0.9869  (-63 141 65 -61):(-64 142 37 -65)
      IMP:P=1 IMP:E=1 VOL=3.49E2  $ Sigmoid Colon Wall

```

32	3	-0.9869	-62 139 66 -67	IMP:P=1 IMP:E=1 VOL=6.00E2	\$ Transverse Colon Wall
33	3	-0.9869	-60 140 61 -59 -83	IMP:P=1 IMP:E=1 VOL=4.28E2	\$ Descending Colon wall
35	3	-0.9869	-72	IMP:P=1 IMP:E=1 VOL=3.29E1	\$ ovary
36	3	-0.9869	-73	IMP:P=1 IMP:E=1 VOL=3.29E1	\$ ovary
37	3	-0.9869	-74 75 -76 6 -77	IMP:P=1 IMP:E=1 VOL=1.44E2	\$ thyroid
38	4	-1.4862	-82 83 37 -78 80 (79:-81)	IMP:P=1 IMP:E=1 VOL=3.02E3	\$ pelvis
39	4	-1.4862	-84 78 -85 102	IMP:P=1 IMP:E=1 VOL=4.32E3	\$ spine
40	3	-0.9869	-83 86 -50 88 -87 #30 #32 #33 #63 #64 #65	IMP:P=1 IMP:E=1 VOL=5.41E3	\$ small int.
41	3	-0.9869	-43 144 -4 #700	IMP:P=1 IMP:E=1 VOL=3.16E3	\$ breast
42	3	-0.9869	-44 144 -4 #700	IMP:P=1 IMP:E=1 VOL=3.16E3	\$ breast
43	3	-0.9869	-92 65	IMP:P=1 IMP:E=1 VOL=7.12E2	\$ kidney
44	3	-0.9869	-93 -94	IMP:P=1 IMP:E=1 VOL=7.12E2	\$ kidney
45	3	-0.9869	-95	IMP:P=1 IMP:E=1 VOL=1.49E3	\$ bladder
46	3	-0.9869	-96	IMP:P=1 IMP:E=1 VOL=8.70E2	\$ spleen
47	3	-0.9869	-98 99 (-65:100)	IMP:P=1 IMP:E=1 VOL=2.99E2	\$ pancreas
48	3	-0.9869	-101	IMP:P=1 IMP:E=1 VOL=1.46E2	\$ thymus
49	4	-1.4862	47 -102 #60 #61	IMP:P=1 IMP:E=1 VOL=4.20E3	\$ skull
50	4	-1.4862	-103 708 -37	IMP:P=1 IMP:E=1 VOL=6.99E3	\$ leg bone
51	4	-1.4862	-104 708 -37	IMP:P=1 IMP:E=1 VOL=6.99E3	\$ leg bone
52	3	-0.9869	-105 92	IMP:P=1 IMP:E=1 VOL=4.81E1	\$ adrenal
53	3	-0.9869	-106 93	IMP:P=1 IMP:E=1 VOL=4.81E1	\$ adrenal
54	4	-1.4862	37 -111 -112	IMP:P=1 IMP:E=1 VOL=2.24E3	\$ arm bone
55	4	-1.4862	37 -111 -113	IMP:P=1 IMP:E=1 VOL=2.24E3	\$ arm bone
56	4	-1.4862	4 114 -115 116 -117 -118 119	IMP:P=1 IMP:E=1 VOL=4.85E2	\$ scapulae
57	4	-1.4862	4 114 -115 116 -117 -120 121	IMP:P=1 IMP:E=1 VOL=4.85E2	\$ scapulae
58	4	-1.4862	-4 -122 -123 124	IMP:P=1 IMP:E=1 VOL=1.33E2	\$ clavicle
59	4	-1.4862	-4 -122 -125 126	IMP:P=1 IMP:E=1 VOL=1.33E2	\$ clavicle
60	3	-0.9869	-33 128 129 -130 133 -134 -4 #700	IMP:P=1 IMP:E=1 VOL=1.20E1	\$ eye lense
61	3	-0.9869	-33 128 -131 132 133 -134 -4 #700	IMP:P=1 IMP:E=1 VOL=1.20E1	\$ eye lense
62	3	-0.9869	5 -77 -137	IMP:P=1 IMP:E=1 VOL=2.16E2	\$ Oesophagus
63	3	-0.9869	-138 58 -59	IMP:P=1 IMP:E=1 VOL=4.81E2	\$ Ascending Colon Interior
64	3	-0.9869	-139 66 -67	IMP:P=1 IMP:E=1 VOL=6.31E2	\$ Transverse Colon Interior
65	3	-0.9869	61 -140 -59	IMP:P=1 IMP:E=1 VOL=5.09E2	\$ Decending Colon Interior
66	3	-0.9869	(-141 65 -61);(-142 37 -65)	IMP:P=1 IMP:E=1 VOL=1.77E2	\$ Sigmoid colon Interior
67	5	-0.930	-143 144 -4 37 #700	IMP:P=1 IMP:E=1 VOL=2.93E4	\$ Abdoman-Adipose
68	5	-0.930	-144 7 -6 37 #700	IMP:P=1 IMP:E=1 VOL=3.66E4	\$ Subcutaneous Adipose
69	5	-0.930	-37 38 -135 39 #700	IMP:P=1 IMP:E=1 VOL=7.33E3	\$ Left Leg Adipose
70	5	-0.930	-37 38 -136 40 #69 #700	IMP:P=1 IMP:E=1 VOL=7.33E3	\$ Right Leg Adipose
600	0		-601 33 -35 606 : -600 34 35 : &		\$ Head & Neck
			-606 6 33 -607 : -604 44 607 : -613 143 607 : &		\$ Shoulders & Torso
			-603 43 607 : -607 144 37 -606 43 44 143 : &		\$ Breasts & Abdomen
			-609 135 39 40 38 -37 : -610 136 40 39 38 -37 : &		\$ Legs
			-38 608 -609 : -38 608 -610 : &		\$ Feet
			-38 708 -610 40 : -38 708 -609 39		
			IMP:P=1 IMP:E=1 VOL=1.55E4		
700	5	-1.04	701 -33 -35 6 : 700 -34 35 102 : &		\$ Head & Neck
			706 -6 701 -144 : 707 -144 37 -6 : &		\$ Shoulders & Torso
			703 -43 144 : 704 -44 144 : 713 -143 144 : &		\$ Breasts

-135 709 38 -37 : -136 710 38 -37 : & \$ Legs
 -708 38 -136 : -708 38 -135 : -708 38 -104 : &
 -708 38 -103 IMP:P=1 IMP:E=1 VOL=1.49E4
 71 0 1 IMP:P=0 IMP:E=0

C Surface Cards

1 RPP -20.621 20.621 -20.701 10.621 -75.201 89.201
 2 SQ 23.04 10.24 1 0 0 0 -508.96 8.0 0 40.9
 3 SQ 23.04 10.24 1 0 0 0 -508.96 2.35 0 40.9
 4 PY 0.0
 5 PZ 40.92
 6 PZ 66
 706 PZ 65.8
 606 PZ 66.2
 7 SQ 1 4 0 0 0 0 -353.44 0 0 0
 8 SQ 1 3.2383 0 0 0 0 -241.18 0 0 0
 9 SQ 1 3.0914 0 0 0 0 -256 0 0 0
 10 PZ 42.24
 11 PZ 33.0
 12 PZ 34.32
 13 PZ 35.64
 14 PZ 36.96
 15 PZ 38.28
 16 PZ 39.60
 17 PZ 43.56
 18 PZ 44.88
 19 PZ 46.20
 20 PZ 47.52
 21 PZ 48.84
 22 PZ 50.16
 23 PZ 51.48
 24 PZ 52.80
 25 PZ 54.12
 26 PZ 55.44
 27 PZ 56.76
 28 PZ 58.08
 29 PZ 59.40
 30 PZ 60.72
 31 PZ 62.04
 32 PZ 63.36
 33 SQ 88.36 43.56 0 0 0 0 -3848.96 0 0 0
 701 SQ 2.06640625 1 0 0 0 0 -84.64 0 0 0
 601 SQ 1.993079585 1 0 0 0 0 -92.16 0 0 0
 34 SQ 5941.33 2928.97 3848.96 0 0 0 -258804.18 0 0 80.8
 700 SQ 0.024414 0.011815 0.015625 0 0 0 -1 0 0 80.8
 600 SQ 0.021626 0.010851 0.014172 0 0 0 -1 0 0 80.8
 35 PZ 80.8
 36 PZ 89
 37 PZ 0
 38 PZ -75
 608 PZ -75.2
 708 PZ -74.8
 39 601 GQ 1 1 0.00012 0 0 -0.2 -18.8 0 0.022492 1.057139
 40 600 GQ 1 1 0.00012 0 0 0.2 18.8 0 0.022492 1.057139
 41 SQ 23.04 10.24 1 0 0 0 -508.96 -8.0 0 40.9
 42 SQ 23.04 10.24 1 0 0 0 -508.96 -2.35 0 40.9

43 SQ 1.079585 .54167 1.846154 0 0 0 -78 -8 -4.4 47
703 SQ 0.014516 0.007182 0.025195 0 0 0 -1 -8 -4.4 47
603 SQ 0.013212 0.006719 0.022277 0 0 0 -1 -8 -4.4 47
44 SQ 1.079585 .54167 1.846154 0 0 0 -78 8 -4.4 47
704 SQ 0.014516 0.007182 0.025195 0 0 0 -1 8 -4.4 47
604 SQ 0.013212 0.006719 0.022277 0 0 0 -1 8 -4.4 47
45 PY -4.88
46 SQ 3.4294 1 9.7656 0 0 0 -25 0 -1.88 13.16
47 SQ 2.2367 1 1.8878 0 0 0 -71.4025 0 0 81.8
48 SQ 56.55 234.396 0 0 0 -13255.193 0 0 0
49 P 9 7 -7.3256 -296.1
50 PZ 25.38
51 PZ 40.42
52 GQ 39.9 52.9 42.3 15.5 -14.3 30.8 -1355.8 1000.7 -4068.3 97042.9
53 SQ 1 1 1 0 0 0 -22.09 -.94 -2.82 47.94
54 P .6943 -.3237 -.6428 -30.56
55 P 4.9061 -2.2876 -0.861 -52.693
56 SQ 4 7.11 1 0 0 0 -56.55 7.71 -4.04 33.09
57 SQ 1 1 0 0 0 0 -5.5225 -8. -2.22 0
58 PZ 13.60
59 PZ 22.56
60 GQ 4.01 3.12 .0963 0 1.088 -0.156 -64.21 -8.93 -.303 251.015
61 PZ 8.21
62 SQ 0 1.9881 5.5225 0 0 0 -10.97928 0 -2.22 23.97
63 TY 2.82 0 8.21 5.39 1.47 1.47
64 TY 2.82 0 0 2.82 1.47 1.47
65 PX 2.82
66 PX -9.87
67 PX 9.87
68 PX -20.42
69 PX 20.42
70 PY -30
71 PY -29
72 SQ 3.3058 11.11 1 0 0 0 -4 5.3 0 13.8
73 SQ 3.31 11.11 1 0 0 0 -4 -5.3 0 13.8
74 C/Z 0 -5.64 2.07
75 C/Z 0 -5.64 0.94
76 PY -5.64
77 PZ 70.7
78 PZ 20.68
79 PZ 13.16
80 PY -2.82
81 PY 4.70
82 C/Z 0 -2.82 11.28
83 C/Z 0 -3.57 10.62
84 SQ 7.07 4.53 0 0 0 0 -25 0 5.17 0
85 PZ 73.8
86 PZ 15.98
87 PY 2.07
88 PY -4.70
89 C/Z 0 -10.3 0.6350
90 C/Z 0 -10.3 0.8636
91 PZ 53.76
92 SQ 1.4938 13.4444 1 0 0 0 -26.73 5.64 5.64 30.55
93 SQ 1.4938 13.4444 1 0 0 0 -26.73 -5.64 5.64 30.55
94 PX -2.82

95 SQ 1 2.0557 2.0557 0 0 0 -24.5818 0 -4.23 7.52
 96 SQ 2.94 9 1 0 0 0 -31.81 10.34 2.82 34.78
 97 PZ 11
 98 SQ 1 225 25 0 0 0 -198.81 0 0 34.78
 99 PX 0
 100 PZ 34.78
 101 SQ 1.78 64 1 0 0 0 -16 -2 -6 59.0
 102 SQ 2.07 1 1.32 0 0 0 -84.64 0 0 80.8
 103 GQ 1 1 .009 0 0 -.2 -18.8 0 1.674 77.536
 104 GQ 1 1 .009 0 0 .2 18.8 0 1.674 77.536
 105 SQ 4.88 43.92 0.44 0 0 0 -9.70 4.23 6.11 35.72
 106 SQ 4.88 43.92 0.44 0 0 0 -9.70 -4.23 6.11 35.72
 107 PX 16
 108 PX 5
 109 PX -5
 110 PX -16
 111 PZ 65
 112 GQ .6944 .1550 0 0 0 .0128 -24.8611 0 -.2372 222.2569
 113 GQ .6944 .1550 0 0 0 -.0128 24.8611 0 -.2372 222.2569
 114 SQ 1 3.0246 0 0 0 0 -256 0 0 0
 115 SQ 1 3.7687 0 0 0 0 -318.98 0 0 0
 116 PZ 47.85
 117 PZ 63.26
 118 P 0.25 -1 0 0
 119 P 0.8 -1 0 0
 120 P -0.25 -1 0 0
 121 P -0.8 -1 0 0
 122 TZ 0 10.43 64.16 18.8 0.7410 0.7410
 123 P 0.89415 1 0 10.43
 124 P 7.0342 1 0 10.43
 125 P -0.89415 1 0 10.43
 126 P -7.0342 1 0 10.43
 C 2 concentric elliptical cylinders and planes to define eye lenses
 127 SQ 100 64 0 0 0 0 -6400 0 0 0
 128 SQ 77.44 36 0 0 0 0 -2787.87 0 0 0
 129 PX 2
 130 PX 4
 131 PX -2
 132 PX -4
 133 PZ 78.0
 134 PZ 80.0
 C Leg Subcutaneous Adipose
 135 601 GQ 4.607843 4.607843 0 0 0 -1 -93.63 0 0 0
 709 601 GQ 4.607843 4.607843 0 0 0 -1 -92.7 0 0 0
 609 GQ 4.607843 4.607843 0 0 0 -1 -95 0 0 0
 136 600 GQ 4.607843 4.607843 0 0 0 1 93.63 0 0 0
 710 600 GQ 4.607843 4.607843 0 0 0 1 92.7 0 0 0
 610 GQ 4.607843 4.607843 0 0 0 1 95 0 0 0
 C Oesophagus
 137 SQ 0.16 1.0 0 0 0 0 -0.16 0.5 2.4 0
 C Colon Wall
 138 SQ 1 1 0 0 0 0 -2.839225 -8.0 -2.22 0
 139 SQ 0 0.837225 3.441025 0 0 0 -2.880912156 0 -2.36 23.97
 140 GQ 1.651 2.235 0.0685 0 0.779 -0.064 -26.45 -6.39 -0.598 106.82
 141 TY 2.82 0 8.21 5.39 0.85 0.85
 142 TY 2.82 0 0 2.82 0.85 0.85

C Abdomen Adipose
143 SQ 1 1.1954 0.9879 0 0 0 -268.957 0 -5.5 16.5
713 SQ 0.00381 0.004565 0.003764 0 0 0 -1 0 -5.5 16.5
613 SQ 0.003629 0.004328 0.003586 0 0 0 -1 0 -5.5 16.5
C Torso Subcutaneous Adipose
144 SQ 1 3.840396 0 0 0 0 -416.976 0 0 0
707 SQ 0.002446 0.009574 0 0 0 0 -1 0 0 0
607 SQ 0.002352 0.008866 0 0 0 0 -1 0 0 0

C Data Cards
C Transformation Cards
TR600 -0.1
TR601 0.1
C

C Sources
SDEF PAR=2 ERG=D1 CEL=600 POS 0 0 -80.5
RAD=D3 EXT=D4 EFF=1E-4 AXS 0 0 1
SI1 L 0.029458 0.722893 0.0297792 0.080183 0.284298
0.636973 0.36448
SP1 0.013568 0.01752 0.025171 0.025448 0.058825
0.07057 0.788898
SI3 0 20.21
SP3 -21 1
SI4 0 174.75
SP4 -21 0
C

C Material Cards
C THIS IS THE COMPOSITION FOR AIR
M1 7014 -.7558 8016 -.2314 18000 -.0128
C THIS IS THE COMPOSITION FOR LUNG TISSUE
M2 1001 -.1021
6012 -.1001
7014 -.0280
8016 -.7596
11023 -.0019
15031 -.0008
16032 -.0023
17000 -.0027
19000 -.0020
20000 -.0001
26000 -.0004

C THE COMPOSITION FOR TOTAL BODY MINUS SKELETON AND LUNGS
M3 1001 -.1047
6012 -.2302
7014 -.0234
8016 -.6321
11023 -.0013
12000 -.0002
15031 -.0024
16032 -.0022
17000 -.0014
19000 -.0021

C THE COMPOSITION FOR SKELETAL TISSUE
M4 1001 -.0704
6012 -.2279
8016 -.4856

7014 -.0387
11023 -.0032
12000 -.0011
15031 -.0694
16032 -.0017
17000 -.0014
19000 -.0015
20000 -.0991

c Adult Tissues (Density = 1.04 g/cc)

M5 1001 -0.10454

6012 -0.22663
7014 -0.02490
8016 -0.63525
11023 -0.00112
12000 -0.00013
14000 -0.00030
15031 -0.00134
16032 -0.00204
17000 -0.00133
19000 -0.00208
20000 -0.00024
26000 -0.00005
30000 -0.00003
37085 -0.000007217
37087 -0.000002783
40000 -0.00001

C

C Tally Cards

*F8:P 35 36 T

FC8 Gonad Gamma Dose

*F28:P 37

FC28 Thyroid Gamma Dose

*F48:P 9 10 11 12 13 14 15 16 17 18 19 20 38 39 49
50 51 54 55 56 57 58 59 T

FC48 Bone Gamma Dose

*F68:P 2 24 T

FC68 Lung Gamma Dose

*F88:P 29

FC88 Stomach Gamma Dose

*F108:P 30 31 32 33 63 64 65 66 T

FC108 Colon Gamma Dose

*F128:P 45

FC128 Bladder Gamma Dose

*F148:P 27

FC148 Liver Gamma Dose

*F168:P 62

FC168 Oesophagus Gamma Dose

*F188:P 700

FC188 Skin Gamma Dose

*F208:P 26 28 40 43 44 46 47 48 52 53 25 T

FC208 Other Gamma Dose

*F228:P 41 42 T

FC228 Breast Gamma Dose

NPS 5E7

RAND GEN=2 SEED=1561615651

PHYS:P 4J 1

PRINT
MODE P E

APPENDIX G

POSTMENOPAUSAL ADIPOSE FEMALE INPUT FILE

Neutron & Induced Photon in Adipose PM MIRDETTE Phantom: Oes & Colon Wall

C Sr-90 Skin Source

1	1	-0.001293	-1 (607:-37:606) (-606:601:35) & (600:-35) (603:4) (604:4) (37:-608:609) & (37:-608:610) (613:4:-37) IMP:P=1 IMP:E=1	
2	2	-0.2958	((-2 -4 3):(-2 4)) 5 IMP:P=1 IMP:E=1 VOL=8.22E3	\$ left lung
3	3	-0.9869	-7 5 -6 (-8:32) 84 101 #2 #24 #28 & #54 #55 #58 #59 #62 #700 IMP:P=1 IMP:E=1 VOL=4.38E4	
4	3	-0.9869	-7 8 -32 116 112 113 #15 #16 #17 & #18 #19 #20 #56 #57 #700 IMP:P=1 IMP:E=1 VOL=2.52E4	
5	3	-0.9869	-7 8 -116 5 112 113 #9 #13 #14 #700 IMP:P=1 IMP:E=1 VOL=1.18E4	\$ torso
6	3	-0.9869	-7 50 -5 56 84 96 105 106 112 113 #10 #11 & #12 #27 #43 #44 #47 #700 IMP:P=1 IMP:E=1 VOL=5.21E4	\$ torso
7	3	-0.9869	-7 97 -50 (83:-86:87:-88)72 73 112 & 113 #25 #30 #33 #38 #39 #43 #44 & #63 #64 #65 #700 IMP:P=1 IMP:E=1 VOL=5.22E4	
8	3	-0.9869	-7 37 -97 95 112 113 #31 #33 #38 & #65 #66 #700 IMP:P=1 IMP:E=1 VOL=4.55E4	\$ torso
9	4	-1.4862	8 -9 5 -10 IMP:P=1 IMP:E=1 VOL=2.83E2	\$ rib
10	4	-1.4862	8 -9 11 -12 IMP:P=1 IMP:E=1 VOL=2.83E2	\$ rib
11	4	-1.4862	8 -9 13 -14 IMP:P=1 IMP:E=1 VOL=2.83E2	\$ rib
12	4	-1.4862	8 -9 15 -16 IMP:P=1 IMP:E=1 VOL=2.83E2	\$ rib
13	4	-1.4862	8 -9 17 -18 IMP:P=1 IMP:E=1 VOL=2.83E2	\$ rib
14	4	-1.4862	8 -9 19 -20 IMP:P=1 IMP:E=1 VOL=2.83E2	\$ rib
15	4	-1.4862	8 -9 21 -22 IMP:P=1 IMP:E=1 VOL=2.83E2	\$ rib
16	4	-1.4862	8 -9 23 -24 IMP:P=1 IMP:E=1 VOL=2.83E2	\$ rib
17	4	-1.4862	8 -9 25 -26 IMP:P=1 IMP:E=1 VOL=2.83E2	\$ rib
18	4	-1.4862	8 -9 27 -28 IMP:P=1 IMP:E=1 VOL=2.83E2	\$ rib
19	4	-1.4862	8 -9 29 -30 IMP:P=1 IMP:E=1 VOL=2.83E2	\$ rib
20	4	-1.4862	8 -9 31 -32 IMP:P=1 IMP:E=1 VOL=2.83E2	\$ rib
21	3	-0.9869	((35 -34):(-33 6 -35)) 102 (84:85) #37 #60 #61 #62 #700 IMP:P=1 IMP:E=1 VOL=9.24E3	\$ head
22	3	-0.9869	-37 38 -39 103 #700 IMP:P=1 IMP:E=1 VOL=6.44E4	\$ left leg
23	3	-0.9869	-37 38 -40 104 #22 #700 IMP:P=1 IMP:E=1 VOL=6.44E4	\$ right leg
24	2	-0.2958	((-41 -4 42):(-41 4)) 5 IMP:P=1 IMP:E=1 VOL=8.22E3	\$ right lung
25	3	-0.9869	45 -46 IMP:P=1 IMP:E=1 VOL=4.89E2	\$ uterus
26	3	-0.9869	-47 IMP:P=1 IMP:E=1 VOL=6.97E3	\$ brain
27	3	-0.9869	50 -51 -48 -49 IMP:P=1 IMP:E=1 VOL=8.84E3	\$ liver
28	3	-0.9869	(-52 54):(-53 -54 55) IMP:P=1 IMP:E=1 VOL=3.01E3	\$ heart
29	3	-0.9869	-56 IMP:P=1 IMP:E=1 VOL=1.99E3	\$ stomach
30	3	-0.9869	-57 138 58 -59 IMP:P=1 IMP:E=1 VOL=4.53E2	\$ Ascending Colon Wall
31	3	-0.9869	(-63 141 65 -61) : (-64 142 37 -65) IMP:P=1 IMP:E=1 VOL=3.49E2	\$ Sigmoid Colon Wall
32	3	-0.9869	-62 139 66 -67 IMP:P=1 IMP:E=1 VOL=6.00E2	\$ Transverse Colon Wall
33	3	-0.9869	-60 140 61 -59 -83 IMP:P=1 IMP:E=1 VOL=4.28E2	\$ Descending Colon wall
35	3	-0.9869	-72 IMP:P=1 IMP:E=1 VOL=3.29E1	\$ ovary

36 3 -0.9869 -73 IMP:P=1 IMP:E=1 VOL=3.29E1 \$ ovary
37 3 -0.9869 -74 75 -76 6 -77 IMP:P=1 IMP:E=1 VOL=1.44E2 \$ thyroid
38 4 -1.4862 -82 83 37 -78 80 (79:-81) IMP:P=1 IMP:E=1 VOL=3.02E3 \$ pelvis
39 4 -1.4862 -84 78 -85 102 IMP:P=1 IMP:E=1 VOL=4.32E3 \$ spine
40 3 -0.9869 -83 86 -50 88 -87 #30 #32 #33 #63 #64 #65
IMP:P=1 IMP:E=1 VOL=5.41E3 \$ small int.
41 3 -0.9869 -43 7 -4 #700 IMP:P=1 IMP:E=1 VOL=2.85E3 \$ breast
42 3 -0.9869 -44 7 -4 #700 IMP:P=1 IMP:E=1 VOL=2.85E3 \$ breast
43 3 -0.9869 -92 65 IMP:P=1 IMP:E=1 VOL=7.12E2 \$ kidney
44 3 -0.9869 -93 -94 IMP:P=1 IMP:E=1 VOL=7.12E2 \$ kidney
45 3 -0.9869 -95 IMP:P=1 IMP:E=1 VOL=1.49E3 \$ bladder
46 3 -0.9869 -96 IMP:P=1 IMP:E=1 VOL=8.70E2 \$ spleen
47 3 -0.9869 -98 99 (-65:100) IMP:P=1 IMP:E=1 VOL=2.99E2 \$ pancreas
48 3 -0.9869 -101 IMP:P=1 IMP:E=1 VOL=1.46E2 \$ thymus
49 4 -1.4862 47 -102 #60 #61 IMP:P=1 IMP:E=1 VOL=4.20E3 \$ skull
50 4 -1.4862 -103 708 -37 IMP:P=1 IMP:E=1 VOL=6.99E3 \$ leg bone
51 4 -1.4862 -104 708 -37 IMP:P=1 IMP:E=1 VOL=6.99E3 \$ leg bone
52 3 -0.9869 -105 92 IMP:P=1 IMP:E=1 VOL=4.81E1 \$ adrenal
53 3 -0.9869 -106 93 IMP:P=1 IMP:E=1 VOL=4.81E1 \$ adrenal
54 4 -1.4862 37 -111 -112 IMP:P=1 IMP:E=1 VOL=2.24E3 \$ arm bone
55 4 -1.4862 37 -111 -113 IMP:P=1 IMP:E=1 VOL=2.24E3 \$ arm bone
56 4 -1.4862 4 114 -115 116 -117 -118 119 IMP:P=1 IMP:E=1
VOL=4.78E2 \$ scapulae
57 4 -1.4862 4 114 -115 116 -117 -120 121 IMP:P=1 IMP:E=1
VOL=4.78E2 \$ scapulae
58 4 -1.4862 -4 -122 -123 124 IMP:P=1 IMP:E=1 VOL=1.32E2 \$ clavicle
59 4 -1.4862 -4 -122 -125 126 IMP:P=1 IMP:E=1 VOL=1.32E2 \$ clavicle
60 3 -0.9869 -33 128 129 -130 133 -134 -4 #700 IMP:P=1
IMP:E=1 VOL=1.20E1 \$ eye lense
61 3 -0.9869 -33 128 -131 132 133 -134 -4 #700 IMP:P=1
IMP:E=1 VOL=1.20E1 \$ eye lense
62 3 -0.9869 5 -77 -137 IMP:P=1 IMP:E=1 VOL=2.16E2 \$ Oesophagus
63 3 -0.9869 -138 58 -59 IMP:P=1 IMP:E=1 VOL=4.81E2 \$ Ascending Colon Interior
64 3 -0.9869 -139 66 -67 IMP:P=1 IMP:E=1 VOL=6.31E2 \$ Transverse Colon Interior
65 3 -0.9869 61 -140 -59 IMP:P=1 IMP:E=1 VOL=5.09E2 \$ Decending Colon Interior
66 3 -0.9869 (-141 65 -61):(-142 37 -65) IMP:P=1 IMP:E=1
VOL=1.77E2 \$ Sigmoid colon Interior
67 3 -0.9869 -143 7 -4 #700 IMP:P=1 IMP:E=1 VOL=3.45E4 \$ Abdoman-Adipose
600 0 -600 35 34 : -601 33 -35 606 : & \$ Head & Neck
-606 6 33 -607 43 44 -4 : &
-607 7 -6 37 43 44 -4 143 : & \$ Shoulders & Torso
-606 6 33 -607 4 : &
-607 7 -6 37 4 44 43 :
-603 43 607 -4 : -604 44 607 -4 : & \$ Breasts
-610 40 -37 38 : -609 39 -37 38 : & \$ Legs
-38 608 -609 : -38 608 -610 : & \$ Feet
-38 708 -610 40 : -38 708 -609 39 : &
143 -613 7 IMP:P=1 IMP:E=1 VOL=1.70E4
700 5 -1.04 -7 707 -706 37 : -6 706 -707 701 : & \$ Body & Shoulders
701 -33 -35 706 : 700 -34 35 102 : & \$ Head and Neck
-43 703 7 : -44 704 7 : & \$ Breasts
-143 713 7 : -708 38 -40 : -708 38 -39 : & \$ Abdemon
-40 710 -37 38 : -39 709 -37 38 : & \$ Legs
-708 38 -104 : -708 38 -103
IMP:P=1 IMP:E=1 VOL=1.59E4
68 0 1 IMP:P=0 IMP:E=0

1 RPP -21.602 21.602 -23.101 11.601 -75.201 89.201
2 SQ 23.04 10.24 1 0 0 0 -508.96 8.0 0 40.9
3 SQ 23.04 10.24 1 0 0 0 -508.96 2.35 0 40.9
4 PY 0.0
5 PZ 40.92
6 PZ 66
706 PZ 65.8
606 PZ 66.2
7 SQ 1 3.52385 0 0 0 0 -457.96 0 0 0
707 SQ 0.002225 0.007972 0 0 0 0 -1 0 0 0
607 SQ 0.002143 0.007432 0 0 0 0 -1 0 0 0
8 SQ 1 3.2383 0 0 0 0 -241.18 0 0 0
9 SQ 1 3.0914 0 0 0 0 -256 0 0 0
10 PZ 42.24
11 PZ 33.0
12 PZ 34.32
13 PZ 35.64
14 PZ 36.96
15 PZ 38.28
16 PZ 39.60
17 PZ 43.56
18 PZ 44.88
19 PZ 46.20
20 PZ 47.52
21 PZ 48.84
22 PZ 50.16
23 PZ 51.48
24 PZ 52.80
25 PZ 54.12
26 PZ 55.44
27 PZ 56.76
28 PZ 58.08
29 PZ 59.40
30 PZ 60.72
31 PZ 62.04
32 PZ 63.36
33 SQ 88.36 43.56 0 0 0 0 -3848.96 0 0 0
701 SQ 0.024414 0.011815 0 0 0 0 -1 0 0 0
601 SQ 0.021626 0.010851 0 0 0 0 -1 0 0 0
34 SQ 5941.33 2928.97 3848.96 0 0 0 -258804.18 0 0 80.8
700 SQ 0.024414 0.011815 0.015625 0 0 0 -1 0 0 80.8
600 SQ 0.021626 0.010851 0.014172 0 0 0 -1 0 0 80.8
35 PZ 80.8
36 PZ 94
37 PZ 0
38 PZ -75
708 PZ -74.8
608 PZ -75.2
39 601 GQ 5 5 0 0 0 -1 -106.5 0 0 0
709 601 GQ 5 5 0 0 0 -1 -105.5 0 0 0
609 GQ 5 5 0 0 0 -1 -108 0 0 0
40 600 GQ 5 5 0 0 0 1 106.5 0 0 0
710 600 GQ 5 5 0 0 0 1 105.5 0 0 0
610 GQ 5 5 0 0 0 1 108 0 0 0
41 SQ 23.04 10.24 1 0 0 0 -508.96 -8.0 0 40.9

42 SQ 23.04 10.24 1 0 0 0 -508.96 -2.35 0 40.9
43 SQ 1.079585 .54167 1.846154 0 0 0 -78 -8 -5 47
703 SQ 0.014516 0.007182 0.025195 0 0 0 -1 -8 -5 47
603 SQ 0.013212 0.006719 0.022277 0 0 0 -1 -8 -5 47
44 SQ 1.079585 .54167 1.846154 0 0 0 -78 8 -5 47
704 SQ 0.014516 0.007182 0.025195 0 0 0 -1 8 -5 47
604 SQ 0.013212 0.006719 0.022277 0 0 0 -1 8 -5 47
45 PY -4.88
46 SQ 3.4294 1 9.7656 0 0 0 -25 0 -1.88 13.16
47 SQ 2.2367 1 1.8878 0 0 0 -71.4025 0 0 81.8
48 SQ 56.55 234.396 0 0 0 0 -13255.193 0 0 0
49 P 9 7 -7.3256 -296.1
50 PZ 25.38
51 PZ 40.42
52 GQ 39.9 52.9 42.3 15.5 -14.3 30.8 -1355.8
1000.7 -4068.3 97042.9
53 SQ 1 1 1 0 0 0 -22.09 -.94 -2.82 47.94
54 P .6943 -.3237 -.6428 -30.56
55 P 4.9061 -2.2876 -0.861 -52.693
56 SQ 4 7.11 1 0 0 0 -56.55 7.71 -4.04 33.09
57 SQ 1 1 0 0 0 0 -5.5225 -8. -2.22 0
58 PZ 13.60
59 PZ 22.56
60 GQ 4.01 3.12 .0963 0 1.088 -0.156 -64.21
-8.93 -.303 251.015
61 PZ 8.21
62 SQ 0 1.9881 5.5225 0 0 0 -10.97928 0 -2.22 23.97
63 TY 2.82 0 8.21 5.39 1.47 1.47
64 TY 2.82 0 0 2.82 1.47 1.47
65 PX 2.82
66 PX -9.87
67 PX 9.87
68 PX -21.4
69 PX 21.4
70 PY -30
71 PY -29
72 SQ 3.3058 11.11 1 0 0 0 -4 5.3 0 13.8
73 SQ 3.31 11.11 1 0 0 0 -4 -5.3 0 13.8
74 C/Z 0 -5.64 2.07
75 C/Z 0 -5.64 0.94
76 PY -5.64
77 PZ 70.7
78 PZ 20.68
79 PZ 13.16
80 PY -2.82
81 PY 4.70
82 C/Z 0 -2.82 11.28
83 C/Z 0 -3.57 10.62
84 SQ 7.07 4.53 0 0 0 0 -25 0 5.17 0
85 PZ 73.8
86 PZ 15.98
87 PY 2.07
88 PY -4.70
89 C/Z 0 -10.3 0.6350
90 C/Z 0 -10.3 0.8636
91 PZ 53.76

92 SQ 1.4938 13.4444 1 0 0 0 -26.73 5.64 5.64 30.55
 93 SQ 1.4938 13.4444 1 0 0 0 -26.73 -5.64 5.64 30.55
 94 PX -2.82
 95 SQ 1 2.0557 2.0557 0 0 0 -24.5818 0 -4.23 7.52
 96 SQ 2.94 9 1 0 0 0 -31.81 10.34 2.82 34.78
 97 PZ 11
 98 SQ 1 225 25 0 0 0 -198.81 0 0 34.78
 99 PX 0
 100 PZ 34.78
 101 SQ 1.78 64 1 0 0 0 -16 -2 -6 59.0
 102 SQ 2.07 1 1.32 0 0 0 -84.64 0 0 80.8
 103 GQ 1 1 .009 0 0 -.2 -18.8 0 1.674 77.536
 104 GQ 1 1 .009 0 0 .2 18.8 0 1.674 77.536
 105 SQ 4.88 43.92 0.44 0 0 0 -9.70 4.23 6.11 35.72
 106 SQ 4.88 43.92 0.44 0 0 0 -9.70 -4.23 6.11 35.72
 107 PX 16
 108 PX 5
 109 PX -5
 110 PX -16
 111 PZ 65
 112 GQ .6944 .1550 0 0 0 .0128 -24.8611 0 -.2372 222.2569
 113 GQ .6944 .1550 0 0 0 -.0128 24.8611 0 -.2372 222.2569
 114 SQ 1 3.0246 0 0 0 0 -256 0 0 0
 115 SQ 1 3.7687 0 0 0 0 -318.98 0 0 0
 116 PZ 47.85
 117 PZ 63.26
 118 P 0.25 -1 0 0
 119 P 0.8 -1 0 0
 120 P -0.25 -1 0 0
 121 P -0.8 -1 0 0
 122 TZ 0 10.43 64.16 18.8 0.7410 0.7410
 123 P 0.89415 1 0 10.43
 124 P 7.0342 1 0 10.43
 125 P -0.89415 1 0 10.43
 126 P -7.0342 1 0 10.43
 C 2 concentric elliptical cylinders and planes to define eye lenses
 127 SQ 100 64 0 0 0 0 -6400 0 0 0
 128 SQ 77.44 36 0 0 0 0 -2787.87 0 0 0
 129 PX 2
 130 PX 4
 131 PX -2
 132 PX -4
 133 PZ 78.0
 134 PZ 80.0
 C segmenting planes for RBM regions in leg and arm bones
 135 PZ -21.375
 136 PZ 49.55
 C Oesophagus
 137 SQ 0.16 1.0 0 0 0 0 -0.16 0.5 2.4 0
 C Colon Wall
 138 SQ 1 1 0 0 0 0 -2.839225 -8.0 -2.22 0
 139 SQ 0 0.837225 3.441025 0 0 0 -2.880912156
 0 -2.36 23.97
 140 GQ 1.651 2.235 0.0685 0 0.779 -0.064
 -26.45 -6.39 -0.598 106.82
 141 TY 2.82 0 8.21 5.39 0.85 0.85

142 TY 2.82 0 0 2.82 0.85 0.85
C Abdomen Adipose
143 SQ 1 1.0506 0.9879 0 0 0 -268.957 0 -6.9 16.5
713 SQ 0.003810 0.004006 0.003764 0 0 0 -1 0 -6.9 16.5
613 SQ 0.003629 0.003810 0.003586 0 0 0 -1 0 -6.9 16.5

tr600 -0.1
tr601 0.1

C

C Source Cards

SDEF PAR=2 ERG=D1 CEL=600 POS 0 0 -80.5

RAD=D3 EXT=D4 EFF=1E-4 AXS 0 0 1

C Sr-90/Y-90 SDEF

SII 0 0.0001 0.00011 0.00012 0.00013 0.00014 0.00015

0.00016 0.00018 0.0002 0.00022 0.00024 0.00026

0.00028 0.0003 0.00032 0.00036 0.0004 0.00045

0.0005 0.00055 0.0006 0.00065 0.0007 0.00075

0.0008 0.00085 0.0009 0.001 0.0011 0.0012

0.0013 0.0014 0.0015 0.0016 0.0018 0.002

0.0022 0.0024 0.0026 0.0028 0.003 0.0032

0.0036 0.004 0.0045 0.005 0.0055 0.006

0.0065 0.007 0.0075 0.008 0.0085 0.009

0.01 0.011 0.012 0.013 0.014 0.015

0.016 0.018 0.02 0.022 0.024 0.026

0.028 0.03 0.032 0.036 0.04 0.045

0.05 0.055 0.06 0.065 0.07 0.075

0.08 0.085 0.09 0.1 0.11 0.12

0.13 0.14 0.15 0.16 0.18 0.2

0.22 0.24 0.26 0.28 0.3 0.32

0.36 0.4 0.45 0.5 0.55 0.6

0.65 0.7 0.75 0.8 0.85 0.9

1 1.1 1.2 1.3 1.4 1.5

1.6 1.8 2 2.2 2.28399992

SP1 0 3.287899971 3.285899878 3.285899878 3.285899878 3.285899878

3.28489995 3.284999967 3.284999967 3.284999967 3.284999967

3.284000039 3.284000039 3.284000039 3.283000112 3.283000112

3.283000112 3.281999946 3.281000018 3.281000018 3.280000091

3.278999925 3.277999997 3.277999997 3.27700007 3.275999904

3.274999976 3.274999976 3.274000049 3.271999955 3.271000028

3.268999934 3.268000007 3.265999913 3.264999986 3.263100117

3.260100096 3.257100075 3.254100055 3.251100034 3.248100013

3.245099992 3.242199957 3.239199936 3.233199894 3.227200091

3.219299972 3.212300003 3.204300106 3.203499943 3.201800078

3.201099902 3.199400067 3.198799908 3.198099971 3.196400106

3.195000023 3.192600012 3.190199971 3.18779996 3.18539995

3.184100091 3.181700051 3.177899957 3.173199892 3.169400036

3.166700065 3.162999958 3.160300016 3.156599909 3.153899938

3.149699986 3.145500004 3.139999956 3.136599988 3.133300006

3.130000055 3.127700001 3.12440002 3.122199982 3.119899958

3.117699891 3.115400106 3.109900087 3.104200065 3.097499907

3.088700116 3.079800069 3.068799943 3.055699974 3.022999972

2.980699897 2.925899982 2.857600063 2.774599969 2.675100088

2.559099913 2.424399972 2.103500009 1.7245 1.216499984

0.780600011 0.608900011 0.616900027 0.622600019 0.626299977

0.628099978 0.628199995 0.626600027 0.623600006 0.613300025

0.597299993 0.575299978 0.546500027 0.510100007 0.465299994

0.411500007 0.279000014 0.129899994 0.01528
SI3 0 20.21
SP3 -21 1
SI4 0 174.75
SP4 -21 0
C Tally Cards
*F8:P 35 36 T
FC8 Gonad Gamma Dose
*F18:E 35 36 T
FC18 Gonad Electron Dose
*F28:P 37
FC28 Thyroid Gamma Dose
*F38:E 37
FC38 Thyroid Electron Dose
*F48:P 9 10 11 12 13 14 15 16 17 18 19 20 38 39 49
50 51 54 55 56 57 58 59 T
FC48 Bone Gamma Dose
*F58:E 9 10 11 12 13 14 15 16 17 18 19 20 38 39 49
50 51 54 55 56 57 58 59 T
FC58 Bone Electron Dose
*F68:P 2 24 T
FC68 Lung Gamma Dose
*F78:E 2 24 T
FC78 Lung Electron Dose
*F88:P 29
FC88 Stomach Gamma Dose
*F98:E 29
FC98 Stomach Electron Dose
*F108:P 30 31 32 33 63 64 65 66
FC108 Colon Gamma Dose
*F118:E 30 31 32 33 63 64 65 66
FC118 Colon Electron Dose
*F128:P 45
FC128 Bladder Gamma Dose
*F138:E 45
FC138 Bladder Electron Dose
*F148:P 27
FC148 Liver Gamma Dose
*F158:E 27
FC158 Liver Electron Dose
*F168:P 62
FC168 Oesophagus Gamma Dose
*F178:E 62
FC178 Oesophagus Electron Dose
*F188:P 700
FC188 Skin Gamma Dose
*F198:E 700
FC198 Skin Electron Dose
*F208:P 26 28 40 43 44 46 47 48 52 53 25 T
FC208 Other Gamma Dose
*F228:P 41 42
FC228 Breast Gamma Dose
*F238:E 41 42
FC238 Breast Electron Dose
C Material Cards
C THIS IS THE COMPOSITION FOR AIR

M1 7014 -.7558 8016 -.2314 18000 -.0128
C THIS IS THE COMPOSITION FOR LUNG TISSUE
M2 1001 -.1021
6012 -.1001
7014 -.0280
8016 -.7596
11023 -.0019
15031 -.0008
16032 -.0023
17000 -.0027
19000 -.0020
20000 -.0001
26000 -.0004
C THE COMPOSITION FOR TOTAL BODY MINUS SKELETON AND LUNGS
M3 1001 -.1047
6012 -.2302
7014 -.0234
8016 -.6321
11023 -.0013
12000 -.0002
15031 -.0024
16032 -.0022
17000 -.0014
19000 -.0021
C THE COMPOSITION FOR SKELETAL TISSUE
M4 1001 -.0704
6012 -.2279
8016 -.4856
7014 -.0387
11023 -.0032
12000 -.0011
15031 -.0694
16032 -.0017
17000 -.0014
19000 -.0015
20000 -.0991
c Adult Tissues (Density = 1.04 g/cc)
M5 1001 -0.10454
6012 -0.22663
7014 -0.02490
8016 -0.63525
11023 -0.00112
12000 -0.00013
14000 -0.00030
15031 -0.00134
16032 -0.00204
17000 -0.00133
19000 -0.00208
20000 -0.00024
26000 -0.00005
30000 -0.00003
37085 -0.000007217
37087 -0.000002783
40000 -0.00001
NPS IE8
RAND GEN=2 SEED=1561615651

phys:p 4J 1
PRINT
MODE P E

APPENDIX H

EFFECTIVE DOSE CONTRIBUTION BY ORGAN TO PATIENT

Table H.1 Effective Dose Contribution by Organ to Reference Male Patient for 37 GBq/m²
Surface Contamination (mSv/hr)

Organ	⁶⁰ Co	¹⁹² Ir	²⁴¹ Am	¹³⁷ Cs	¹³¹ I
Gonads	3.11E+01	1.23E+01	5.86E-01	7.90E+00	4.60E+00
Stomach	3.14E+01	1.15E+01	2.71E-01	7.55E+00	4.34E+00
Colon Wall	4.03E+01	1.50E+01	3.32E-01	9.78E+00	5.62E+00
Bladder	2.44E+01	9.21E+00	2.25E-01	5.94E+00	3.44E+00
Lungs	1.30E+01	4.96E+00	1.27E-01	3.20E+00	1.86E+00
Bone	2.38E+01	9.82E+00	6.69E-01	5.96E+00	3.57E+00
Liver	4.99E+00	1.85E+00	4.34E-02	1.21E+00	6.94E-01
Thyroid	1.01E+01	3.88E+00	1.18E-01	2.52E+00	1.46E+00
Esophagus	4.69E+00	1.76E+00	3.44E-02	1.15E+00	6.66E-01
Skin	1.33E+00	6.53E-01	1.07E-01	4.00E-01	2.46E-01
Other	1.20E+01	4.58E+00	1.04E-01	2.98E+00	1.71E+00
Total	1.97E+02	7.55E+01	2.61E+00	4.86E+01	2.82E+01

Table H.2 Effective Dose Contribution by Organ to Reference Female Patient for 37 GBq/m²
Surface Contamination (mSv/hr)

Organ	⁶⁰ Co	¹⁹² Ir	²⁴¹ Am	¹³⁷ Cs	¹³¹ I
Gonads	1.42E+01	5.24E+00	9.42E-02	3.36E+00	1.96E+00
Stomach	2.51E+01	9.46E+00	2.20E-01	6.11E+00	3.54E+00
Colon Wall	2.97E+01	1.10E+01	2.35E-01	7.12E+00	4.11E+00
Bladder	2.01E+01	7.57E+00	1.61E-01	4.85E+00	2.82E+00
Lungs	1.19E+01	4.59E+00	1.14E-01	2.94E+00	1.72E+00
Bone	2.49E+01	1.05E+01	6.11E-01	6.27E+00	3.79E+00
Liver	4.47E+00	1.68E+00	3.84E-02	1.08E+00	6.27E-01
Thyroid	8.42E+00	3.24E+00	1.03E-01	2.10E+00	1.23E+00
Esophagus	5.51E+00	2.09E+00	4.13E-02	1.34E+00	7.82E-01
Skin	2.12E+00	1.03E+00	1.61E-01	6.29E-01	3.86E-01
Other	5.45E+00	2.06E+00	4.38E-02	1.33E+00	7.73E-01
Breast	2.15E+01	8.51E+00	4.80E-01	5.47E+00	3.21E+00
Total	1.73E+02	6.70E+01	2.30E+00	4.26E+01	2.49E+01

Table H.3 Effective Dose Contribution by Organ to Adipose Male Patient for 37 GBq/m²
Surface Contamination (mSv/hr)

Organ	⁶⁰ Co	¹⁹² Ir	²⁴¹ Am	¹³⁷ Cs	¹³¹ I
Gonads	4.42E+01	1.79E+01	8.94E-01	1.13E+01	6.70E+00
Stomach	2.40E+01	8.96E+00	1.95E-01	5.78E+00	3.35E+00
Colon	3.31E+01	1.22E+01	2.38E-01	7.86E+00	4.53E+00
Bladder	2.04E+01	7.67E+00	1.56E-01	4.89E+00	2.85E+00
Lungs	1.08E+01	4.17E+00	1.00E-01	2.67E+00	1.56E+00
Bone	2.78E+01	1.19E+01	6.48E-01	7.00E+00	4.26E+00
Liver	3.75E+00	1.39E+00	2.99E-02	9.02E-01	5.19E-01
Thyroid	1.14E+01	4.48E+00	1.39E-01	2.87E+00	1.68E+00
Esophagus	4.44E+00	1.68E+00	3.26E-02	1.08E+00	6.27E-01
Skin	1.76E+00	8.42E-01	1.32E-01	5.18E-01	3.17E-01
Other	5.64E+00	2.13E+00	5.15E-02	1.38E+00	8.01E-01
Breasts	1.21E+01	4.83E+00	3.28E-01	3.11E+00	1.83E+00
Total	1.99E+02	7.81E+01	2.94E+00	4.93E+01	2.90E+01

Table H.4 Effective Dose Contribution by Organ to Adipose Female Patient for 37 GBq/m²
Surface Contamination (mSv/hr)

Organ	⁶⁰ Co	¹⁹² Ir	²⁴¹ Am	¹³⁷ Cs	¹³¹ I
Gonads	1.42E+01	5.24E+00	9.42E-02	3.36E+00	1.96E+00
Stomach	2.51E+01	9.46E+00	2.20E-01	6.11E+00	3.54E+00
Colon Wall	2.97E+01	1.10E+01	2.35E-01	7.12E+00	4.11E+00
Bladder	2.01E+01	7.57E+00	1.61E-01	4.85E+00	2.82E+00
Lungs	1.19E+01	4.59E+00	1.14E-01	2.94E+00	1.72E+00
Bone	2.49E+01	1.05E+01	6.11E-01	6.27E+00	3.79E+00
Liver	4.47E+00	1.68E+00	3.84E-02	1.08E+00	6.27E-01
Thyroid	8.42E+00	3.24E+00	1.03E-01	2.10E+00	1.23E+00
Esophagus	5.51E+00	2.09E+00	4.13E-02	1.34E+00	7.82E-01
Skin	2.12E+00	1.03E+00	1.61E-01	6.29E-01	3.86E-01
Other	5.45E+00	2.06E+00	4.38E-02	1.33E+00	7.73E-01
Breast	2.15E+01	8.51E+00	4.80E-01	5.47E+00	3.21E+00
Total	1.73E+02	6.70E+01	2.30E+00	4.26E+01	2.49E+01

Table H.5 Effective Dose Contribution by Organ to Postmenopausal Adipose Female Patient for 37 GBq/m² Surface Contamination (mSv/hr)

Organ	⁶⁰Co	¹⁹²Ir	²⁴¹Am	¹³⁷Cs	¹³¹I
Gonads	2.71E+01	1.03E+01	1.54E-01	6.37E+00	3.73E+00
Stomach	2.24E+01	8.47E+00	1.92E-01	5.44E+00	3.17E+00
Colon	2.68E+01	9.90E+00	2.10E-01	6.42E+00	3.71E+00
Bladder	1.83E+01	6.91E+00	1.47E-01	4.41E+00	2.57E+00
Lungs	1.13E+01	4.36E+00	1.05E-01	2.78E+00	1.63E+00
Bone	2.44E+01	1.05E+01	5.85E-01	6.14E+00	3.74E+00
Liver	4.04E+00	1.51E+00	3.32E-02	9.76E-01	5.65E-01
Thyroid	1.37E+01	5.37E+00	1.72E-01	3.43E+00	2.01E+00
Esophagus	5.47E+00	2.10E+00	4.03E-02	1.33E+00	7.69E-01
Skin	1.87E+00	9.11E-01	1.45E-01	5.57E-01	3.42E-01
Other	5.32E+00	2.01E+00	4.22E-02	1.30E+00	7.49E-01
Breast	2.02E+01	8.04E+00	4.67E-01	5.14E+00	3.03E+00
Total	1.81E+02	7.03E+01	2.29E+00	4.43E+01	2.60E+01

APPENDIX I

EFFECTIVE DOSE TO HEALTHCARE PROVIDER DUE TO EXTERNALLY CONTAMINATED PATIENT

Table I.1 Effective Dose Contribution by Organ from Reference Male Patient to the Reference Male Healthcare Provider for 37GBq/m² Surface Contamination (mSv/hr)

Organ	Co-60	Ir-192	Am-241	Cs-137	I-131
Gonads	2.58E+00	8.77E-01	1.46E-02	5.95E-01	3.17E-01
Stomach	6.61E+00	3.07E+00	9.27E-02	1.75E+00	1.12E+00
Colon Wall	8.56E+00	3.76E+00	9.81E-02	2.19E+00	1.38E+00
Bladder	5.41E+00	2.35E+00	6.58E-02	1.38E+00	8.51E-01
Lungs	1.59E+00	6.61E-01	1.80E-02	4.05E-01	2.44E-01
Bone	2.13E+00	8.99E-01	4.69E-02	5.26E-01	3.22E-01
Liver	8.97E-01	3.96E-01	1.13E-02	2.34E-01	1.46E-01
Thyroid	9.09E-01	3.85E-01	1.10E-02	2.34E-01	1.43E-01
Esophagus	4.54E-01	1.65E-01	2.81E-03	1.03E-01	6.25E-02
Skin	9.98E-02	4.24E-02	5.15E-03	2.61E-02	1.57E-02
Other	1.43E+00	6.04E-01	1.43E-02	3.59E-01	2.18E-01
Total	3.07E+01	1.32E+01	3.81E-01	7.80E+00	4.81E+00

Table I.2 Effective Dose Contribution by Organ from Reference Female Patient to the Reference Male Healthcare Provider for 37GBq/m² Surface Contamination (mSv/hr)

Organ	Co-60	Ir-192	Am-241	Cs-137	I-131
Gonads	2.04E+00	6.63E-01	1.14E-02	4.71E-01	2.40E-01
Stomach	5.57E+00	2.60E+00	7.93E-02	1.49E+00	9.51E-01
Colon Wall	7.15E+00	3.12E+00	8.18E-02	1.83E+00	1.13E+00
Bladder	4.54E+00	1.92E+00	5.44E-02	1.15E+00	7.12E-01
Lungs	1.36E+00	5.71E-01	1.51E-02	3.47E-01	2.09E-01
Bone	1.82E+00	7.64E-01	3.96E-02	4.48E-01	2.74E-01
Liver	7.28E-01	3.20E-01	8.91E-03	1.88E-01	1.17E-01
Thyroid	7.30E-01	3.31E-01	1.02E-02	1.99E-01	1.21E-01
Esophagus	3.73E-01	1.36E-01	2.29E-03	9.03E-02	5.00E-02
Skin	8.39E-02	3.52E-02	4.16E-03	2.19E-02	1.32E-02
Other	1.19E+00	5.08E-01	1.19E-02	3.10E-01	1.88E-01
Total	2.56E+01	1.10E+01	3.19E-01	6.55E+00	4.01E+00

Table I.3 Effective Dose Contribution by Organ from Adipose Male Patient to the Reference Male Healthcare Provider for 37GBq/m² Surface Contamination (mSv/hr)

Organ	Co-60	Ir-192	Am-241	Cs-137	I-131
Gonads	2.76E+00	9.07E-01	1.75E-02	6.31E-01	3.36E-01
Stomach	6.83E+00	3.05E+00	8.65E-02	1.78E+00	1.12E+00
Colon Wall	8.87E+00	3.70E+00	9.03E-02	2.21E+00	1.36E+00
Bladder	6.14E+00	2.57E+00	6.99E-02	1.56E+00	9.50E-01
Lungs	1.74E+00	7.07E-01	1.80E-02	4.35E-01	2.59E-01
Bone	2.42E+00	9.94E-01	5.01E-02	5.88E-01	3.57E-01
Liver	8.68E-01	3.66E-01	9.63E-03	2.20E-01	1.34E-01
Thyroid	1.01E+00	4.41E-01	1.33E-02	2.67E-01	1.60E-01
Esophagus	5.09E-01	1.72E-01	3.01E-03	1.11E-01	6.50E-02
Skin	1.09E-01	4.40E-02	4.73E-03	2.77E-02	1.64E-02
Other	1.49E+00	5.85E-01	1.42E-02	3.80E-01	2.28E-01
Total	3.27E+01	1.35E+01	3.77E-01	8.22E+00	4.98E+00

Table I.4 Effective Dose Contribution by Organ from Adipose Female Patient to the Reference Male Healthcare Provider for 37GBq/m² Surface Contamination (mSv/hr)

Organ	Co-60	Ir-192	Am-241	Cs-137	I-131
Gonads	2.62E+00	8.04E-01	1.59E-02	6.03E-01	3.32E-01
Stomach	6.87E+00	3.13E+00	9.67E-02	1.80E+00	1.14E+00
Colon Wall	8.58E+00	3.76E+00	9.67E-02	2.21E+00	1.36E+00
Bladder	5.38E+00	2.34E+00	6.65E-02	1.39E+00	8.68E-01
Lungs	1.66E+00	6.98E-01	1.87E-02	4.25E-01	2.55E-01
Bone	2.22E+00	9.29E-01	4.85E-02	5.44E-01	3.32E-01
Liver	8.74E-01	3.77E-01	1.05E-02	2.24E-01	1.39E-01
Thyroid	1.03E+00	4.22E-01	1.13E-02	2.61E-01	1.52E-01
Esophagus	4.75E-01	1.79E-01	3.08E-03	1.12E-01	6.59E-02
Skin	1.02E-01	4.27E-02	4.96E-03	2.66E-02	1.59E-02
Other	1.48E+00	5.99E-01	1.32E-02	3.66E-01	2.24E-01
Total	3.13E+01	1.33E+01	3.86E-01	7.96E+00	4.88E+00

Table I.5 Effective Dose Contribution by Organ from Postmenopausal Adipose Female Patient to the Reference Male Healthcare Provider for 37GBq/m² Surface Contamination (mSv/hr)

Organ	Co-60	Ir-192	Am-241	Cs-137	I-131
Gonads	2.58E+00	8.46E-01	1.60E-02	5.87E-01	3.17E-01
Stomach	6.48E+00	2.94E+00	8.80E-02	1.70E+00	1.06E+00
Colon Wall	8.30E+00	3.57E+00	9.04E-02	2.14E+00	1.31E+00
Bladder	5.60E+00	2.38E+00	6.49E-02	1.44E+00	8.80E-01
Lungs	1.63E+00	6.65E-01	1.75E-02	4.07E-01	2.45E-01
Bone	2.20E+00	9.17E-01	4.71E-02	5.38E-01	3.28E-01
Liver	8.33E-01	3.58E-01	9.78E-03	2.14E-01	1.32E-01
Thyroid	9.56E-01	4.01E-01	1.14E-02	2.50E-01	1.53E-01
Esophagus	4.52E-01	1.64E-01	3.13E-03	1.06E-01	6.25E-02
Skin	1.00E-01	4.14E-02	4.63E-03	2.60E-02	1.54E-02
Other	1.45E+00	5.88E-01	1.41E-02	3.51E-01	2.13E-01
Total	3.06E+01	1.29E+01	3.67E-01	7.76E+00	4.72E+00

Table I.6 Effective Dose Contribution by Organ from Reference Male Patient to the Reference Female Healthcare Provider for 37GBq/m² Surface Contamination (mSv/hr)

Organ	Co-60	Ir-192	Am-241	Cs-137	I-131
Gonads	3.58E+00	1.55E+00	3.38E-02	9.44E-01	5.45E-01
Stomach	6.17E+00	2.90E+00	9.20E-02	1.64E+00	1.05E+00
Colon Wall	7.26E+00	3.22E+00	8.36E-02	1.89E+00	1.18E+00
Bladder	5.26E+00	2.25E+00	6.25E-02	1.32E+00	8.21E-01
Lungs	1.69E+00	6.98E-01	1.82E-02	4.24E-01	2.56E-01
Bone	2.28E+00	9.59E-01	4.83E-02	5.62E-01	3.44E-01
Liver	9.64E-01	4.30E-01	1.24E-02	2.52E-01	1.58E-01
Thyroid	8.04E-01	3.50E-01	1.09E-02	2.17E-01	1.30E-01
Esophagus	5.51E-01	2.05E-01	3.37E-03	1.30E-01	7.90E-02
Skin	1.52E-01	6.33E-02	6.99E-03	3.93E-02	2.35E-02
Other	7.97E-01	3.32E-01	7.44E-03	2.03E-01	1.17E-01
Breasts	2.63E+00	1.19E+00	6.98E-02	7.01E-01	4.38E-01
Total	3.21E+01	1.41E+01	4.49E-01	8.32E+00	5.15E+00

Table I.7 Effective Dose Contribution by Organ from Reference Female Patient to the Reference Female Healthcare Provider for 37GBq/m² Surface Contamination (mSv/hr)

Organ	Co-60	Ir-192	Am-241	Cs-137	I-131
Gonads	3.17E+00	1.23E+00	2.85E-02	8.13E-01	4.74E-01
Stomach	5.18E+00	2.45E+00	7.75E-02	1.40E+00	8.90E-01
Colon Wall	6.07E+00	2.65E+00	6.78E-02	1.56E+00	9.70E-01
Bladder	4.44E+00	1.87E+00	5.17E-02	1.13E+00	6.88E-01
Lungs	1.43E+00	5.91E-01	1.52E-02	3.63E-01	2.18E-01
Bone	1.94E+00	8.14E-01	4.09E-02	4.77E-01	2.91E-01
Liver	7.71E-01	3.45E-01	9.70E-03	2.02E-01	1.26E-01
Thyroid	7.18E-01	2.99E-01	1.03E-02	1.87E-01	1.12E-01
Esophagus	4.92E-01	1.89E-01	3.21E-03	1.21E-01	6.93E-02
Skin	1.28E-01	5.25E-02	5.66E-03	3.31E-02	1.97E-02
Other	6.35E-01	2.73E-01	6.65E-03	1.65E-01	9.97E-02
Breasts	2.23E+00	1.00E+00	5.68E-02	5.93E-01	3.70E-01
Total	2.72E+01	1.18E+01	3.74E-01	7.05E+00	4.33E+00

Table I.8 Effective Dose Contribution by Organ from Adipose Male Patient to the Reference Female Healthcare Provider for 37GBq/m² Surface Contamination (mSv/hr)

Organ	Co-60	Ir-192	Am-241	Cs-137	I-131
Gonads	3.63E+00	1.52E+00	3.50E-02	9.39E-01	5.60E-01
Stomach	6.23E+00	2.83E+00	8.52E-02	1.64E+00	1.04E+00
Colon Wall	7.50E+00	3.16E+00	7.67E-02	1.90E+00	1.16E+00
Bladder	6.05E+00	2.52E+00	6.63E-02	1.53E+00	9.35E-01
Lungs	1.82E+00	7.30E-01	1.80E-02	4.55E-01	2.68E-01
Bone	2.57E+00	1.05E+00	5.14E-02	6.24E-01	3.78E-01
Liver	9.24E-01	3.89E-01	1.05E-02	2.34E-01	1.43E-01
Thyroid	9.24E-01	3.87E-01	1.32E-02	2.33E-01	1.51E-01
Esophagus	6.27E-01	2.23E-01	3.58E-03	1.59E-01	8.43E-02
Skin	1.66E-01	6.54E-02	6.43E-03	4.18E-02	2.45E-02
Other	8.13E-01	3.37E-01	7.30E-03	2.07E-01	1.21E-01
Breasts	2.76E+00	1.20E+00	6.38E-02	7.22E-01	4.41E-01
Total	3.40E+01	1.44E+01	4.37E-01	8.68E+00	5.30E+00

Table I.9 Effective Dose Contribution by Organ from Adipose Female Patient to the Reference Female Healthcare Provider for 37GBq/m² Surface Contamination (mSv/hr)

Organ	Co-60	Ir-192	Am-241	Cs-137	I-131
Gonads	3.53E+00	1.45E+00	3.51E-02	8.66E-01	5.71E-01
Stomach	6.33E+00	2.95E+00	9.29E-02	1.69E+00	1.07E+00
Colon Wall	7.40E+00	3.23E+00	8.18E-02	1.91E+00	1.18E+00
Bladder	5.19E+00	2.24E+00	6.22E-02	1.34E+00	8.28E-01
Lungs	1.74E+00	7.14E-01	1.83E-02	4.38E-01	2.63E-01
Bone	2.35E+00	9.88E-01	5.00E-02	5.78E-01	3.53E-01
Liver	9.34E-01	4.09E-01	1.17E-02	2.41E-01	1.50E-01
Thyroid	9.17E-01	3.72E-01	1.28E-02	2.31E-01	1.42E-01
Esophagus	5.68E-01	2.09E-01	3.89E-03	1.38E-01	7.88E-02
Skin	1.55E-01	6.38E-02	6.75E-03	4.00E-02	2.37E-02
Other	7.77E-01	3.18E-01	7.53E-03	1.95E-01	1.19E-01
Breasts	2.72E+00	1.22E+00	6.79E-02	7.20E-01	4.47E-01
Total	3.26E+01	1.42E+01	4.51E-01	8.39E+00	5.22E+00

Table I.10 Effective Dose Contribution by Organ from Postmenopausal Adipose Female Patient to the Reference Female Healthcare Provider for 37GBq/m² Surface Contamination (mSv/hr)

Organ	Co-60	Ir-192	Am-241	Cs-137	I-131
Gonads	3.50E+00	1.42E+00	3.38E-02	8.92E-01	5.44E-01
Stomach	6.06E+00	2.76E+00	8.65E-02	1.60E+00	1.00E+00
Colon Wall	7.18E+00	3.08E+00	7.69E-02	1.86E+00	1.12E+00
Bladder	5.43E+00	2.31E+00	6.26E-02	1.40E+00	8.57E-01
Lungs	1.68E+00	6.79E-01	1.71E-02	4.20E-01	2.51E-01
Bone	2.34E+00	9.72E-01	4.82E-02	5.72E-01	3.48E-01
Liver	8.82E-01	3.86E-01	1.07E-02	2.28E-01	1.42E-01
Thyroid	8.79E-01	3.65E-01	1.17E-02	2.36E-01	1.34E-01
Esophagus	5.88E-01	2.13E-01	3.83E-03	1.44E-01	7.89E-02
Skin	1.52E-01	6.18E-02	6.31E-03	3.90E-02	2.30E-02
Other	7.30E-01	3.18E-01	7.37E-03	1.90E-01	1.15E-01
Breasts	2.59E+00	1.15E+00	6.24E-02	6.81E-01	4.22E-01
Total	3.20E+01	1.37E+01	4.27E-01	8.26E+00	5.04E+00

Table I.11 Effective Dose Contribution by Organ from Reference Male Patient to the Adipose Male Healthcare Provider for 37GBq/m² Surface Contamination (mSv/hr)

Organ	Co-60	Ir-192	Am-241	Cs-137	I-131
Gonads	7.25E-01	1.22E+00	3.05E-02	8.25E-01	4.66E-01
Stomach	1.29E+00	2.18E+00	5.01E-02	1.32E+00	7.94E-01
Colon Wall	1.27E+00	2.15E+00	3.41E-02	1.39E+00	7.96E-01
Bladder	8.38E-01	1.41E+00	2.12E-02	9.22E-01	5.29E-01
Lungs	3.27E-01	5.51E-01	1.23E-02	3.49E-01	2.04E-01
Bone	4.77E-01	8.04E-01	2.96E-02	4.74E-01	2.89E-01
Liver	1.80E-01	3.03E-01	6.76E-03	1.87E-01	1.13E-01
Thyroid	1.87E-01	3.16E-01	7.01E-03	1.96E-01	1.15E-01
Esophagus	7.81E-02	1.32E-01	1.89E-03	8.96E-02	5.17E-02
Skin	2.87E-02	4.84E-02	5.51E-03	3.02E-02	1.80E-02
Other	5.16E-01	1.95E-01	3.70E-03	1.25E-01	7.06E-02
Breasts	1.37E+00	6.92E-01	5.21E-02	3.93E-01	2.37E-01
Total	7.29E+00	1.00E+01	2.55E-01	6.30E+00	3.68E+00

Table I.12 Effective Dose Contribution by Organ from Reference Female Patient to the Adipose Male Healthcare Provider for 37GBq/m² Surface Contamination (mSv/hr)

Organ	Co-60	Ir-192	Am-241	Cs-137	I-131
Gonads	2.57E+00	8.35E-01	1.73E-02	5.71E-01	3.27E-01
Stomach	4.49E+00	1.88E+00	4.44E-02	1.14E+00	6.97E-01
Colon Wall	4.92E+00	1.73E+00	2.77E-02	1.14E+00	6.44E-01
Bladder	3.08E+00	1.04E+00	1.59E-02	7.10E-01	3.95E-01
Lungs	1.20E+00	4.75E-01	1.04E-02	2.99E-01	1.76E-01
Bone	1.66E+00	6.70E-01	2.46E-02	3.98E-01	2.41E-01
Liver	6.09E-01	2.44E-01	5.38E-03	1.51E-01	9.00E-02
Thyroid	6.66E-01	2.50E-01	5.75E-03	1.64E-01	9.41E-02
Esophagus	3.23E-01	1.13E-01	1.60E-03	7.77E-02	4.35E-02
Skin	9.52E-02	3.92E-02	4.24E-03	2.46E-02	1.46E-02
Other	4.42E-01	1.65E-01	2.90E-03	1.09E-01	6.11E-02
Breasts	1.26E+00	6.02E-01	3.94E-02	3.68E-01	2.11E-01
Total	2.13E+01	8.05E+00	1.99E-01	5.16E+00	2.99E+00

Table I.13 Effective Dose Contribution by Organ from Adipose Male Patient to the Adipose Male Healthcare Provider for 37GBq/m² Surface Contamination (mSv/hr)

Organ	Co-60	Ir-192	Am-241	Cs-137	I-131
Gonads	3.45E+00	1.27E+00	2.78E-02	8.42E-01	4.74E-01
Stomach	5.68E+00	2.32E+00	5.25E-02	1.42E+00	8.52E-01
Colon Wall	6.26E+00	2.18E+00	3.37E-02	1.43E+00	8.24E-01
Bladder	4.11E+00	1.41E+00	2.04E-02	9.61E-01	5.30E-01
Lungs	1.55E+00	5.93E-01	1.27E-02	3.77E-01	2.19E-01
Bone	2.23E+00	8.86E-01	3.22E-02	5.31E-01	3.19E-01
Liver	7.45E-01	2.91E-01	6.25E-03	1.81E-01	1.08E-01
Thyroid	8.88E-01	3.34E-01	8.49E-03	2.10E-01	1.26E-01
Esophagus	4.52E-01	1.44E-01	1.99E-03	9.70E-02	5.55E-02
Skin	1.20E-01	4.69E-02	4.53E-03	3.01E-02	1.75E-02
Other	5.65E-01	1.99E-01	3.50E-03	1.32E-01	7.70E-02
Breasts	1.76E+00	7.13E-01	4.72E-02	4.50E-01	2.52E-01
Total	2.78E+01	1.04E+01	2.51E-01	6.66E+00	3.85E+00

Table I.14 Effective Dose Contribution by Organ from Adipose Female Patient to the Adipose Male Healthcare Provider for 37GBq/m² Surface Contamination (mSv/hr)

Organ	Co-60	Ir-192	Am-241	Cs-137	I-131
Gonads	2.95E+00	1.01E+00	2.24E-02	6.73E-01	3.81E-01
Stomach	5.58E+00	2.31E+00	5.50E-02	1.41E+00	8.54E-01
Colon Wall	5.95E+00	2.12E+00	3.21E-02	1.38E+00	7.89E-01
Bladder	3.62E+00	1.26E+00	1.82E-02	8.25E-01	4.70E-01
Lungs	1.49E+00	5.83E-01	1.29E-02	3.68E-01	2.16E-01
Bone	2.00E+00	8.12E-01	3.03E-02	4.81E-01	2.91E-01
Liver	7.42E-01	2.97E-01	6.55E-03	1.83E-01	1.10E-01
Thyroid	8.39E-01	3.33E-01	7.76E-03	2.15E-01	1.18E-01
Esophagus	4.18E-01	1.45E-01	2.40E-03	9.56E-02	5.58E-02
Skin	1.14E-01	4.66E-02	4.96E-03	2.93E-02	1.74E-02
Other	5.46E-01	1.95E-01	3.25E-03	1.29E-01	7.11E-02
Breasts	1.61E+00	8.19E-01	5.07E-02	4.25E-01	2.76E-01
Total	2.59E+01	9.93E+00	2.46E-01	6.22E+00	3.65E+00

Table I.15 Effective Dose Contribution by Organ from Postmenopausal Adipose Female Patient to the Adipose Male Healthcare Provider for 37GBq/m² Surface Contamination (mSv/hr)

Organ	Co-60	Ir-192	Am-241	Cs-137	I-131
Gonads	2.89E+00	1.02E+00	2.22E-02	6.94E-01	3.83E-01
Stomach	5.40E+00	2.21E+00	5.35E-02	1.35E+00	8.18E-01
Colon Wall	5.90E+00	2.03E+00	3.22E-02	1.35E+00	7.76E-01
Bladder	3.73E+00	1.26E+00	1.95E-02	8.51E-01	4.76E-01
Lungs	1.45E+00	5.62E-01	1.22E-02	3.54E-01	2.08E-01
Bone	2.01E+00	8.08E-01	2.97E-02	4.79E-01	2.89E-01
Liver	7.09E-01	2.83E-01	6.15E-03	1.75E-01	1.04E-01
Thyroid	8.39E-01	3.20E-01	7.73E-03	2.07E-01	1.27E-01
Esophagus	3.97E-01	1.36E-01	2.00E-03	9.32E-02	5.25E-02
Skin	1.12E-01	4.45E-02	4.50E-03	2.84E-02	1.67E-02
Other	5.30E-01	1.94E-01	3.24E-03	1.31E-01	7.53E-02
Breasts	1.51E+00	7.23E-01	4.75E-02	3.94E-01	2.50E-01
Total	2.55E+01	9.58E+00	2.40E-01	6.10E+00	3.58E+00

Table I.16 Effective Dose Contribution by Organ from Reference Male Patient to the Adipose Female Healthcare Provider for 37GBq/m² Surface Contamination (mSv/hr)

Organ	Co-60	Ir-192	Am-241	Cs-137	I-131
Gonads	2.53E+00	9.54E-01	1.34E-02	5.95E-01	3.73E-01
Stomach	5.49E+00	2.38E+00	6.33E-02	1.41E+00	8.63E-01
Colon Wall	5.59E+00	2.09E+00	3.88E-02	1.33E+00	7.75E-01
Bladder	4.30E+00	1.61E+00	2.89E-02	1.03E+00	6.00E-01
Lungs	1.60E+00	6.33E-01	1.52E-02	3.97E-01	2.35E-01
Bone	2.17E+00	9.01E-01	3.71E-02	5.28E-01	3.22E-01
Liver	8.85E-01	3.74E-01	9.31E-03	2.27E-01	1.38E-01
Thyroid	7.51E-01	3.21E-01	8.89E-03	1.94E-01	1.19E-01
Esophagus	5.59E-01	1.87E-01	3.11E-03	1.30E-01	6.78E-02
Skin	1.91E-01	8.17E-02	8.66E-03	5.02E-02	3.03E-02
Other	6.74E-01	2.51E-01	4.87E-03	1.65E-01	9.39E-02
Breasts	3.09E+00	1.42E+00	7.92E-02	8.28E-01	5.22E-01
Total	2.78E+01	1.12E+01	3.11E-01	6.89E+00	4.14E+00

Table I.17 Effective Dose Contribution by Organ from Reference Female Patient to the Adipose Female Healthcare Provider for 37GBq/m² Surface Contamination (mSv/hr)

Organ	Co-60	Ir-192	Am-241	Cs-137	I-131
Gonads	2.02E+00	7.32E-01	9.25E-03	4.68E-01	2.56E-01
Stomach	4.70E+00	2.05E+00	5.66E-02	1.22E+00	7.51E-01
Colon Wall	4.53E+00	1.69E+00	3.10E-02	1.09E+00	6.34E-01
Bladder	3.29E+00	1.19E+00	2.08E-02	7.68E-01	4.43E-01
Lungs	1.36E+00	5.45E-01	1.25E-02	3.37E-01	2.00E-01
Bone	1.81E+00	7.47E-01	3.05E-02	4.40E-01	2.68E-01
Liver	7.08E-01	2.98E-01	7.37E-03	1.80E-01	1.09E-01
Thyroid	7.01E-01	2.67E-01	8.38E-03	1.69E-01	1.01E-01
Esophagus	4.52E-01	1.71E-01	2.53E-03	1.12E-01	6.43E-02
Skin	1.57E-01	6.63E-02	6.69E-03	4.11E-02	2.46E-02
Other	5.52E-01	2.02E-01	3.90E-03	1.31E-01	7.78E-02
Breasts	2.63E+00	1.19E+00	6.52E-02	7.00E-01	4.38E-01
Total	2.29E+01	9.15E+00	2.55E-01	5.65E+00	3.37E+00

Table I.18 Effective Dose Contribution by Organ from Adipose Male Patient to the Adipose Female Healthcare Provider for 37GBq/m² Surface Contamination (mSv/hr)

Organ	Co-60	Ir-192	Am-241	Cs-137	I-131
Gonads	2.93E+00	1.00E+00	1.27E-02	6.67E-01	3.78E-01
Stomach	5.71E+00	2.44E+00	6.28E-02	1.45E+00	8.83E-01
Colon Wall	5.81E+00	2.14E+00	3.81E-02	1.37E+00	7.93E-01
Bladder	4.53E+00	1.56E+00	2.62E-02	1.04E+00	5.85E-01
Lungs	1.73E+00	6.70E-01	1.52E-02	4.20E-01	2.49E-01
Bone	2.42E+00	9.72E-01	3.91E-02	5.78E-01	3.49E-01
Liver	8.47E-01	3.43E-01	8.08E-03	2.12E-01	1.27E-01
Thyroid	9.12E-01	3.44E-01	9.86E-03	2.27E-01	1.35E-01
Esophagus	6.13E-01	2.04E-01	2.94E-03	1.36E-01	7.47E-02
Skin	1.99E-01	8.00E-02	7.35E-03	5.03E-02	2.98E-02
Other	6.76E-01	2.52E-01	4.83E-03	1.67E-01	9.46E-02
Breasts	3.26E+00	1.42E+00	7.31E-02	8.52E-01	5.22E-01
Total	2.96E+01	1.14E+01	3.00E-01	7.17E+00	4.22E+00

Table I.19 Effective Dose Contribution by Organ from Adipose Female Patient to the Adipose Female Healthcare Provider for 37GBq/m² Surface Contamination (mSv/hr)

Organ	Co-60	Ir-192	Am-241	Cs-137	I-131
Gonads	5.37E+00	1.49E+00	2.86E-02	1.14E+00	6.21E-01
Stomach	5.08E+00	2.17E+00	5.47E-02	1.30E+00	7.94E-01
Colon Wall	5.18E+00	1.83E+00	2.93E-02	1.19E+00	6.80E-01
Bladder	3.69E+00	1.23E+00	1.97E-02	8.48E-01	4.81E-01
Lungs	1.55E+00	6.04E-01	1.30E-02	3.77E-01	2.21E-01
Bone	2.12E+00	8.68E-01	3.24E-02	5.11E-01	3.09E-01
Liver	7.72E-01	3.11E-01	7.07E-03	1.92E-01	1.16E-01
Thyroid	1.14E+00	4.58E-01	1.22E-02	2.92E-01	1.72E-01
Esophagus	5.54E-01	1.80E-01	2.86E-03	1.29E-01	7.09E-02
Skin	1.68E-01	6.96E-02	6.66E-03	4.32E-02	2.57E-02
Other	6.48E-01	2.30E-01	4.41E-03	1.54E-01	8.93E-02
Breasts	2.83E+00	1.27E+00	6.79E-02	7.48E-01	4.64E-01
Total	2.91E+01	1.07E+01	2.79E-01	6.93E+00	4.04E+00

Table I.20 Effective Dose Contribution by Organ from Reference Male Patient to the Adipose Female Healthcare Provider for 37GBq/m² Surface Contamination (mSv/hr)

Organ	Co-60	Ir-192	Am-241	Cs-137	I-131
Gonads	2.60E+00	8.65E-01	1.21E-02	5.84E-01	3.21E-01
Stomach	5.36E+00	2.35E+00	6.29E-02	1.39E+00	8.59E-01
Colon Wall	5.38E+00	1.99E+00	3.61E-02	1.29E+00	7.50E-01
Bladder	4.04E+00	1.43E+00	2.43E-02	9.38E-01	5.43E-01
Lungs	1.61E+00	6.29E-01	1.41E-02	3.96E-01	2.32E-01
Bone	2.19E+00	8.91E-01	3.63E-02	5.30E-01	3.20E-01
Liver	8.22E-01	3.39E-01	8.28E-03	2.06E-01	1.25E-01
Thyroid	7.96E-01	3.25E-01	1.05E-02	2.01E-01	1.28E-01
Esophagus	5.72E-01	1.94E-01	3.02E-03	1.29E-01	7.78E-02
Skin	1.85E-01	7.61E-02	7.30E-03	4.75E-02	2.83E-02
Other	6.32E-01	2.43E-01	4.63E-03	1.60E-01	8.93E-02
Breasts	3.05E+00	1.36E+00	7.18E-02	8.01E-01	4.99E-01
Total	2.72E+01	1.07E+01	2.91E-01	6.68E+00	3.97E+00

Table I.21 Effective Dose Contribution by Organ from Reference Female Patient to the Postmenopausal Adipose Female Healthcare Provider for 37GBq/m² Surface Contamination (mSv/hr)

Organ	Co-60	Ir-192	Am-241	Cs-137	I-131
Gonads	5.01E+00	1.83E+00	2.70E-02	1.21E+00	6.64E-01
Stomach	5.07E+00	2.15E+00	5.36E-02	1.29E+00	7.93E-01
Colon Wall	5.12E+00	1.91E+00	3.13E-02	1.22E+00	7.09E-01
Bladder	4.04E+00	1.44E+00	2.41E-02	9.41E-01	5.40E-01
Lungs	1.55E+00	6.12E-01	1.36E-02	3.80E-01	2.25E-01
Bone	2.10E+00	8.73E-01	3.26E-02	5.10E-01	3.12E-01
Liver	8.28E-01	3.43E-01	7.90E-03	2.09E-01	1.27E-01
Thyroid	1.07E+00	4.24E-01	1.06E-02	2.71E-01	1.62E-01
Esophagus	4.91E-01	1.77E-01	2.74E-03	1.19E-01	6.66E-02
Skin	1.75E-01	7.44E-02	7.98E-03	4.58E-02	2.75E-02
Other	6.33E-01	2.34E-01	4.20E-03	1.48E-01	8.48E-02
Breasts	2.89E+00	1.32E+00	7.52E-02	7.71E-01	4.86E-01
Total	2.90E+01	1.14E+01	2.91E-01	7.11E+00	4.19E+00

Table I.22 Effective Dose Contribution by Organ from Adipose Male Patient to the Postmenopausal Adipose Female Healthcare Provider for 37GBq/m² Surface Contamination (mSv/hr)

Organ	Co-60	Ir-192	Am-241	Cs-137	I-131
Gonads	4.22E+00	1.34E+00	2.00E-02	9.28E-01	5.78E-01
Stomach	4.35E+00	1.87E+00	4.53E-02	1.12E+00	6.86E-01
Colon Wall	4.27E+00	1.52E+00	2.46E-02	9.93E-01	5.70E-01
Bladder	3.07E+00	1.06E+00	1.65E-02	7.09E-01	3.95E-01
Lungs	1.32E+00	5.17E-01	1.13E-02	3.27E-01	1.91E-01
Bone	1.76E+00	7.23E-01	2.69E-02	4.25E-01	2.59E-01
Liver	6.66E-01	2.76E-01	6.25E-03	1.68E-01	1.01E-01
Thyroid	9.89E-01	3.66E-01	1.02E-02	2.39E-01	1.38E-01
Esophagus	4.48E-01	1.71E-01	2.31E-03	1.09E-01	6.14E-02
Skin	1.44E-01	6.02E-02	6.17E-03	3.74E-02	2.24E-02
Other	5.63E-01	1.98E-01	3.68E-03	1.30E-01	7.47E-02
Breasts	2.45E+00	1.11E+00	6.16E-02	6.52E-01	4.08E-01
Total	2.42E+01	9.21E+00	2.35E-01	5.83E+00	3.49E+00

Table I.23 Effective Dose Contribution by Organ from Adipose Female Patient to the Postmenopausal Adipose Female Healthcare Provider for 37GBq/m² Surface Contamination (mSv/hr)

Organ	Co-60	Ir-192	Am-241	Cs-137	I-131
Gonads	5.53E+00	1.90E+00	2.58E-02	1.21E+00	6.52E-01
Stomach	5.35E+00	2.25E+00	5.36E-02	1.36E+00	8.33E-01
Colon Wall	5.44E+00	1.94E+00	3.20E-02	1.29E+00	7.25E-01
Bladder	4.12E+00	1.40E+00	2.17E-02	9.53E-01	5.29E-01
Lungs	1.67E+00	6.41E-01	1.36E-02	4.04E-01	2.37E-01
Bone	2.35E+00	9.47E-01	3.49E-02	5.61E-01	3.40E-01
Liver	8.07E-01	3.18E-01	7.03E-03	1.98E-01	1.18E-01
Thyroid	1.33E+00	4.94E-01	1.31E-02	3.10E-01	1.89E-01
Esophagus	5.75E-01	2.00E-01	2.50E-03	1.37E-01	7.31E-02
Skin	1.81E-01	7.21E-02	6.69E-03	4.55E-02	2.69E-02
Other	6.45E-01	2.42E-01	4.14E-03	1.53E-01	8.90E-02
Breasts	3.03E+00	1.32E+00	6.93E-02	7.90E-01	4.85E-01
Total	3.10E+01	1.17E+01	2.84E-01	7.40E+00	4.30E+00

Table I.24 Effective Dose Contribution by Organ from Postmenopausal Adipose Female Patient to the Postmenopausal Adipose Female Healthcare Provider for 37GBq/m² Surface Contamination (mSv/hr)

Organ	Co-60	Ir-192	Am-241	Cs-137	I-131
Gonads	5.06E+00	1.76E+00	2.37E-02	1.11E+00	6.52E-01
Stomach	5.37E+00	2.32E+00	5.95E-02	1.37E+00	8.43E-01
Colon Wall	5.13E+00	1.88E+00	3.14E-02	1.22E+00	7.11E-01
Bladder	3.61E+00	1.25E+00	2.00E-02	8.33E-01	4.68E-01
Lungs	1.59E+00	6.29E-01	1.38E-02	3.91E-01	2.30E-01
Bone	2.12E+00	8.75E-01	3.31E-02	5.13E-01	3.13E-01
Liver	8.09E-01	3.32E-01	7.48E-03	2.02E-01	1.23E-01
Thyroid	1.24E+00	4.74E-01	1.31E-02	3.03E-01	1.75E-01
Esophagus	5.16E-01	1.82E-01	3.06E-03	1.26E-01	7.11E-02
Skin	1.73E-01	7.24E-02	7.28E-03	4.48E-02	2.69E-02
Other	6.32E-01	2.35E-01	3.96E-03	1.47E-01	8.62E-02
Breasts	2.98E+00	1.34E+00	7.33E-02	7.89E-01	4.93E-01
Total	2.92E+01	1.13E+01	2.90E-01	7.05E+00	4.19E+00

Table I.25 Effective Dose Contribution by Organ from Reference Female Patient to the Postmenopausal Adipose Female Healthcare Provider for 37GBq/m² Surface Contamination (mSv/hr)

Organ	Co-60	Ir-192	Am-241	Cs-137	I-131
Gonads	5.37E+00	1.49E+00	2.86E-02	1.14E+00	6.21E-01
Stomach	5.08E+00	2.17E+00	5.47E-02	1.30E+00	7.94E-01
Colon Wall	5.18E+00	1.83E+00	2.93E-02	1.19E+00	6.80E-01
Bladder	3.69E+00	1.23E+00	1.97E-02	8.48E-01	4.81E-01
Lungs	1.55E+00	6.04E-01	1.30E-02	3.77E-01	2.21E-01
Bone	2.12E+00	8.68E-01	3.24E-02	5.11E-01	3.09E-01
Liver	7.72E-01	3.11E-01	7.07E-03	1.92E-01	1.16E-01
Thyroid	1.14E+00	4.58E-01	1.22E-02	2.92E-01	1.72E-01
Esophagus	5.54E-01	1.80E-01	2.86E-03	1.29E-01	7.09E-02
Skin	1.68E-01	6.96E-02	6.66E-03	4.32E-02	2.57E-02
Other	6.48E-01	2.30E-01	4.41E-03	1.54E-01	8.93E-02
Breasts	2.83E+00	1.27E+00	6.79E-02	7.48E-01	4.64E-01
Total	2.91E+01	1.07E+01	2.79E-01	6.93E+00	4.04E+00

APPENDIX J

**EFFECTIVE DOSE TO HEALTHCARE PROVIDER DUE TO
INTERNALLY CONTAMINATED PATIENT**

Table J.1 Effective Dose Contribution by Organ for Reference Male Healthcare Provider from the Reference Male Patient ($\mu\text{Sv/hr}$) /ALI

Organ	⁶⁰ Co (s)	⁶⁰ Co (m)	¹⁹² Ir (s)	¹⁹² Ir (m)	¹⁹² Ir (f)	²⁴¹ Am	¹³⁷ Cs	¹³¹ I
Gonads	0.030	0.184	0.083	0.098	0.250	1.16E-07	0.078	0.026
Stomach	0.144	0.432	0.299	0.345	0.894	7.90E-07	0.219	0.086
Colon Wall	0.183	0.565	0.357	0.416	1.020	7.84E-07	0.278	0.104
Bladder	0.130	0.399	0.256	0.297	0.719	5.85E-07	0.196	0.071
Lungs	0.039	0.120	0.076	0.093	0.217	2.24E-07	0.058	0.023
Bone	0.049	0.153	0.099	0.119	0.290	4.23E-07	0.074	0.029
Liver	0.021	0.067	0.043	0.052	0.108	1.25E-07	0.031	0.013
Thyroid	0.024	0.070	0.048	0.059	0.145	1.71E-07	0.035	0.014
Esophagus	0.011	0.033	0.018	0.022	0.050	2.97E-08	0.015	0.005
Skin	0.002	0.007	0.004	0.005	0.012	1.25E-08	0.004	0.001
Other	0.034	0.105	0.062	0.077	0.170	1.36E-07	0.050	0.019
Total	0.668	2.137	1.345	1.582	3.875	3.40E-06	1.037	0.392

Table J.2 Effective Dose Contribution by Organ for Reference Male Healthcare Provider from the Reference Female Patient ($\mu\text{Sv/hr}$) /ALI

Organ	⁶⁰ Co (s)	⁶⁰ Co (m)	¹⁹² Ir (s)	¹⁹² Ir (m)	¹⁹² Ir (f)	²⁴¹ Am	¹³⁷ Cs	¹³¹ I
Gonads	0.064	0.197	0.086	0.108	0.256	1.57E-07	0.097	0.025
Stomach	0.154	0.466	0.298	0.377	0.968	9.09E-07	0.228	0.088
Colon Wall	0.196	0.609	0.368	0.463	1.093	9.37E-07	0.339	0.106
Bladder	0.139	0.430	0.262	0.329	0.774	7.02E-07	0.244	0.073
Lungs	0.041	0.124	0.077	0.097	0.229	2.40E-07	0.066	0.024
Bone	0.051	0.158	0.099	0.125	0.306	4.51E-07	0.084	0.030
Liver	0.022	0.069	0.044	0.055	0.114	1.37E-07	0.043	0.013
Thyroid	0.024	0.073	0.047	0.059	0.152	1.75E-07	0.040	0.015
Esophagus	0.011	0.033	0.018	0.022	0.056	3.73E-08	0.017	0.006
Skin	0.002	0.008	0.004	0.006	0.013	1.39E-08	0.004	0.001
Other	0.018	0.053	0.030	0.039	0.093	7.92E-08	0.026	0.010
Total	0.721	2.219	1.333	1.680	4.055	3.84E-06	1.189	0.392

Table J.3 Effective Dose Contribution by Organ for Reference Male Healthcare Provider from the Adipose Male Patient ($\mu\text{Sv/hr}$) /ALI

Organ	^{60}Co (s)	^{60}Co (m)	^{192}Ir (s)	^{192}Ir (m)	^{192}Ir (f)	^{241}Am	^{137}Cs	^{131}I
Gonads	0.068	0.207	0.099	0.127	0.341	1.82E-07	0.097	0.030
Stomach	0.133	0.404	0.245	0.311	0.921	5.90E-07	0.226	0.076
Colon Wall	0.175	0.542	0.312	0.397	1.082	6.37E-07	0.289	0.096
Bladder	0.124	0.389	0.234	0.296	0.804	5.41E-07	0.207	0.068
Lungs	0.034	0.106	0.061	0.078	0.213	1.53E-07	0.057	0.021
Bone	0.045	0.141	0.085	0.107	0.292	3.07E-07	0.074	0.027
Liver	0.020	0.062	0.037	0.047	0.112	9.66E-08	0.032	0.012
Thyroid	0.019	0.060	0.035	0.042	0.136	9.77E-08	0.034	0.013
Esophagus	0.009	0.028	0.014	0.017	0.049	1.98E-08	0.014	0.005
Skin	0.002	0.007	0.004	0.005	0.013	9.70E-09	0.004	0.001
Other	0.015	0.045	0.026	0.033	0.084	5.12E-08	0.024	0.008
Total	0.644	1.991	1.152	1.461	4.047	2.69E-06	1.057	0.356

Table J.4 Effective Dose Contribution by Organ for Reference Male Healthcare Provider from the Adipose Female Patient ($\mu\text{Sv/hr}$) /ALI

Organ	^{60}Co (s)	^{60}Co (m)	^{192}Ir (s)	^{192}Ir (m)	^{192}Ir (f)	^{241}Am	^{137}Cs	^{131}I
Gonads	0.067	0.209	0.093	0.118	0.282	1.59E-07	0.086	0.028
Stomach	0.147	0.443	0.280	0.357	1.005	7.86E-07	0.244	0.086
Colon Wall	0.189	0.588	0.350	0.440	1.133	8.37E-07	0.300	0.105
Bladder	0.136	0.422	0.252	0.318	0.790	6.35E-07	0.211	0.072
Lungs	0.037	0.114	0.067	0.086	0.228	1.85E-07	0.059	0.022
Bone	0.048	0.149	0.091	0.115	0.303	3.57E-07	0.076	0.028
Liver	0.021	0.066	0.041	0.052	0.117	1.17E-07	0.033	0.013
Thyroid	0.021	0.067	0.039	0.050	0.145	1.18E-07	0.036	0.015
Esophagus	0.010	0.030	0.016	0.020	0.054	2.78E-08	0.015	0.005
Skin	0.002	0.007	0.004	0.005	0.013	1.16E-08	0.004	0.001
Other	0.016	0.048	0.027	0.035	0.103	6.05E-08	0.026	0.009
Total	0.692	2.144	1.260	1.595	4.173	3.29E-06	1.090	0.385

Table J.5 Effective Dose Contribution by Organ for Reference Male Healthcare Provider from the Postmenopausal Adipose Female Patient ($\mu\text{Sv/hr}$) /ALI

Organ	^{60}Co (s)	^{60}Co (m)	^{192}Ir (s)	^{192}Ir (m)	^{192}Ir (f)	^{241}Am	^{137}Cs	^{131}I
Gonads	0.069	0.212	0.100	0.126	0.441	1.78E-07	0.156	0.028
Stomach	0.141	0.428	0.265	0.337	1.046	6.78E-07	0.350	0.081
Colon Wall	0.182	0.567	0.334	0.421	1.446	7.29E-07	0.451	0.100
Bladder	0.130	0.407	0.247	0.310	1.063	6.16E-07	0.312	0.071
Lungs	0.036	0.111	0.064	0.081	0.257	1.65E-07	0.088	0.021
Bone	0.047	0.145	0.087	0.111	0.359	3.21E-07	0.116	0.027
Liver	0.020	0.064	0.039	0.049	0.169	1.04E-07	0.048	0.012
Thyroid	0.020	0.061	0.037	0.047	0.147	1.01E-07	0.051	0.013
Esophagus	0.010	0.029	0.015	0.019	0.057	2.41E-08	0.022	0.005
Skin	0.002	0.007	0.004	0.005	0.016	1.03E-08	0.006	0.001
Other	0.015	0.046	0.025	0.033	0.108	5.49E-08	0.039	0.009
Total	0.673	2.078	1.216	1.539	5.109	2.98E-06	1.638	0.369

Table J.6 Effective Dose Contribution by Organ for Reference Female Healthcare Provider from the Reference Male Patient ($\mu\text{Sv/hr}$) /ALI

Organ	^{60}Co (s)	^{60}Co (m)	^{192}Ir (s)	^{192}Ir (m)	^{192}Ir (f)	^{241}Am	^{137}Cs	^{131}I
Gonads	0.076	0.230	0.143	0.166	0.425	2.32E-07	0.114	0.398
Stomach	0.134	0.403	0.276	0.316	0.822	7.40E-07	0.205	0.796
Colon Wall	0.155	0.483	0.300	0.351	0.877	6.73E-07	0.240	0.892
Bladder	0.129	0.396	0.249	0.289	0.703	5.57E-07	0.190	0.691
Lungs	0.040	0.123	0.076	0.092	0.215	2.04E-07	0.060	0.234
Bone	0.053	0.162	0.104	0.125	0.306	4.37E-07	0.078	0.307
Liver	0.022	0.070	0.045	0.055	0.115	1.30E-07	0.033	0.133
Thyroid	0.021	0.063	0.043	0.054	0.131	1.61E-07	0.031	0.135
Esophagus	0.013	0.041	0.022	0.027	0.067	4.03E-08	0.019	0.069
Skin	0.004	0.011	0.006	0.008	0.019	1.79E-08	0.005	0.020
Other	0.018	0.053	0.031	0.038	0.096	7.34E-08	0.026	0.101
Breast	0.066	0.202	0.139	0.168	0.380	5.07E-07	0.098	0.406
Total	0.730	2.239	1.435	1.690	4.157	3.77E-06	1.099	4.182

Table J.7 Effective Dose Contribution by Organ for Reference Female Healthcare Provider from the Reference Female Patient ($\mu\text{Sv/hr}$) /ALI

Organ	^{60}Co (s)	^{60}Co (m)	^{192}Ir (s)	^{192}Ir (m)	^{192}Ir (f)	^{241}Am	^{137}Cs	^{131}I
Gonads	0.081	0.242	0.140	0.176	0.442	3.27E-07	0.142	0.043
Stomach	0.141	0.429	0.279	0.353	0.893	8.63E-07	0.215	0.082
Colon Wall	0.168	0.520	0.315	0.395	0.932	8.01E-07	0.289	0.090
Bladder	0.136	0.422	0.255	0.321	0.747	6.69E-07	0.241	0.071
Lungs	0.041	0.127	0.076	0.096	0.225	2.15E-07	0.069	0.025
Bone	0.054	0.168	0.104	0.131	0.322	4.72E-07	0.089	0.031
Liver	0.023	0.073	0.047	0.059	0.122	1.43E-07	0.046	0.014
Thyroid	0.021	0.064	0.044	0.055	0.131	1.62E-07	0.035	0.014
Esophagus	0.014	0.044	0.023	0.028	0.069	4.54E-08	0.020	0.007
Skin	0.004	0.012	0.006	0.008	0.020	1.96E-08	0.006	0.002
Other	0.018	0.054	0.032	0.041	0.096	7.61E-08	0.029	0.010
Breast	0.068	0.206	0.138	0.174	0.403	5.41E-07	0.115	0.074
Total	0.769	2.362	1.459	1.838	4.400	4.33E-06	1.295	0.465

Table J.8 Effective Dose Contribution by Organ for Reference Female Healthcare Provider from the Adipose Male Patient ($\mu\text{Sv/hr}$) /ALI

Organ	^{60}Co (s)	^{60}Co (m)	^{192}Ir (s)	^{192}Ir (m)	^{192}Ir (f)	^{241}Am	^{137}Cs	^{131}I
Gonads	0.070	0.220	0.119	0.153	0.416	2.10E-07	0.114	0.040
Stomach	0.124	0.375	0.227	0.289	0.866	5.75E-07	0.211	0.071
Colon Wall	0.148	0.463	0.265	0.336	0.929	5.43E-07	0.245	0.082
Bladder	0.124	0.387	0.230	0.289	0.787	5.23E-07	0.203	0.068
Lungs	0.036	0.111	0.062	0.078	0.213	1.44E-07	0.059	0.021
Bone	0.048	0.150	0.090	0.114	0.310	3.25E-07	0.079	0.028
Liver	0.021	0.066	0.040	0.050	0.121	1.03E-07	0.034	0.012
Thyroid	0.017	0.054	0.033	0.041	0.119	9.13E-08	0.033	0.012
Esophagus	0.012	0.036	0.018	0.023	0.065	2.89E-08	0.018	0.006
Skin	0.003	0.010	0.005	0.007	0.019	1.38E-08	0.005	0.002
Other	0.016	0.050	0.111	0.034	0.095	6.23E-08	0.025	0.009
Breast	0.058	0.179	1.227	0.141	0.380	3.56E-07	0.099	0.036
Total	0.677	2.102	2.427	1.557	4.320	2.97E-06	1.124	0.387

Table J.9 Effective Dose Contribution by Organ for Reference Female Healthcare Provider from the Adipose Female Patient ($\mu\text{Sv/hr}$) /ALI

Organ	^{60}Co (s)	^{60}Co (m)	^{192}Ir (s)	^{192}Ir (m)	^{192}Ir (f)	^{241}Am	^{137}Cs	^{131}I
Gonads	0.076	0.235	0.137	0.168	0.581	2.34E-07	0.127	0.048
Stomach	0.136	0.411	0.263	0.335	1.024	7.37E-07	0.227	0.089
Colon Wall	0.160	0.494	0.295	0.371	1.251	7.09E-07	0.258	0.101
Bladder	0.133	0.415	0.246	0.310	1.034	5.99E-07	0.207	0.079
Lungs	0.038	0.120	0.069	0.087	0.275	1.76E-07	0.061	0.026
Bone	0.051	0.159	0.097	0.122	0.389	3.78E-07	0.081	0.034
Liver	0.022	0.070	0.044	0.056	0.186	1.24E-07	0.035	0.015
Thyroid	0.019	0.058	0.036	0.045	0.142	1.05E-07	0.032	0.015
Esophagus	0.013	0.040	0.020	0.025	0.080	3.59E-08	0.019	0.008
Skin	0.003	0.011	0.006	0.008	0.024	1.64E-08	0.006	0.002
Other	0.018	0.055	0.029	0.037	0.124	6.19E-08	0.027	0.011
Breast	0.062	0.191	0.123	0.156	0.497	4.24E-07	0.103	0.044
Total	0.730	2.258	1.365	1.720	5.607	3.60E-06	1.184	0.471

Table J.10 Effective Dose Contribution by Organ for Reference Female Healthcare Provider from the Postmenopausal Adipose Female Patient ($\mu\text{Sv/hr}$) /ALI

Organ	^{60}Co (s)	^{60}Co (m)	^{192}Ir (s)	^{192}Ir (m)	^{192}Ir (f)	^{241}Am	^{137}Cs	^{131}I
Gonads	0.073	0.228	0.132	0.167	0.407	2.54E-07	0.184	0.039
Stomach	0.130	0.396	0.250	0.318	0.880	6.33E-07	0.325	0.076
Colon Wall	0.156	0.486	0.286	0.360	0.938	6.33E-07	0.384	0.085
Bladder	0.130	0.404	0.241	0.304	0.777	5.97E-07	0.310	0.069
Lungs	0.037	0.115	0.065	0.082	0.215	1.56E-07	0.092	0.022
Bone	0.050	0.155	0.093	0.118	0.309	3.42E-07	0.123	0.029
Liver	0.021	0.067	0.042	0.052	0.119	1.10E-07	0.051	0.013
Thyroid	0.017	0.054	0.033	0.043	0.121	1.00E-07	0.046	0.012
Esophagus	0.012	0.040	0.018	0.023	0.067	3.20E-08	0.028	0.006
Skin	0.003	0.010	0.006	0.007	0.019	1.47E-08	0.008	0.002
Other	0.016	0.050	0.028	0.035	0.095	5.43E-08	0.041	0.009
Breast	0.060	0.187	0.118	0.150	0.383	3.87E-07	0.148	0.037
Total	0.707	2.193	1.311	1.660	4.330	3.31E-06	1.742	0.399

Table J.11 Effective Dose Contribution by Organ for Adipose Male Healthcare Provider from the Reference Male Patient ($\mu\text{Sv/hr}$) /ALI

Organ	^{60}Co (s)	^{60}Co (m)	^{192}Ir (s)	^{192}Ir (m)	^{192}Ir (f)	^{241}Am	^{137}Cs	^{131}I
Gonads	0.097	0.300	0.166	0.198	0.469	3.66E-07	0.131	0.049
Stomach	0.112	0.332	0.199	0.227	0.617	3.94E-07	0.160	0.060
Colon Wall	0.115	0.358	0.181	0.211	0.546	2.30E-07	0.164	0.058
Bladder	0.079	0.247	0.131	0.152	0.385	1.75E-07	0.112	0.039
Lungs	0.035	0.107	0.063	0.077	0.178	1.53E-07	0.049	0.019
Bone	0.046	0.143	0.090	0.108	0.263	3.25E-07	0.068	0.027
Liver	0.018	0.058	0.034	0.041	0.080	8.20E-08	0.026	0.010
Thyroid	0.020	0.061	0.037	0.046	0.107	1.05E-07	0.030	0.011
Esophagus	0.009	0.029	0.015	0.018	0.041	2.63E-08	0.012	0.005
Skin	0.003	0.008	0.005	0.006	0.014	1.41E-08	0.004	0.002
Other	0.012	0.037	0.022	0.026	0.055	3.47E-08	0.017	0.006
Breast	0.041	0.122	0.079	0.105	0.226	3.08E-07	0.058	0.024
Total	0.587	1.801	1.021	1.215	2.982	2.21E-06	0.830	0.311

Table J.12 Effective Dose Contribution by Organ for Adipose Male Healthcare Provider from the Reference Female Patient ($\mu\text{Sv/hr}$) /ALI

Organ	^{60}Co (s)	^{60}Co (m)	^{192}Ir (s)	^{192}Ir (m)	^{192}Ir (f)	^{241}Am	^{137}Cs	^{131}I
Gonads	0.091	0.279	0.143	0.187	0.393	3.01E-07	0.152	0.041
Stomach	0.117	0.352	0.192	0.207	0.675	4.56E-07	0.144	0.061
Colon Wall	0.122	0.382	0.179	0.194	0.558	2.52E-07	0.189	0.057
Bladder	0.085	0.266	0.127	0.137	0.388	1.81E-07	0.135	0.037
Lungs	0.036	0.111	0.063	0.064	0.189	1.64E-07	0.057	0.020
Bone	0.046	0.144	0.086	0.094	0.265	3.27E-07	0.076	0.027
Liver	0.019	0.059	0.035	0.037	0.084	8.79E-08	0.037	0.011
Thyroid	0.020	0.063	0.037	0.036	0.119	1.25E-07	0.033	0.013
Esophagus	0.010	0.029	0.014	0.014	0.045	2.58E-08	0.014	0.005
Skin	0.003	0.009	0.005	0.005	0.015	1.49E-08	0.005	0.001
Other	0.012	0.036	0.018	0.023	0.060	3.87E-08	0.035	0.006
Breast	0.036	0.106	0.082	0.103	0.238	3.60E-07	0.124	0.025
Total	0.598	1.837	0.982	1.101	3.031	2.33E-06	1.001	0.304

Table J.13 Effective Dose Contribution by Organ for Adipose Male Healthcare Provider from the Adipose Male Patient ($\mu\text{Sv/hr}$) /ALI

Organ	^{60}Co (s)	^{60}Co (m)	^{192}Ir (s)	^{192}Ir (m)	^{192}Ir (f)	^{241}Am	^{137}Cs	^{131}I
Gonads	0.091	0.280	0.148	0.187	0.429	2.81E-07	0.124	0.039
Stomach	0.102	0.307	0.162	0.207	0.644	2.94E-07	0.166	0.054
Colon Wall	0.105	0.333	0.153	0.194	0.548	1.86E-07	0.166	0.052
Bladder	0.074	0.231	0.109	0.137	0.374	1.34E-07	0.109	0.033
Lungs	0.030	0.095	0.050	0.064	0.174	1.03E-07	0.049	0.017
Bone	0.041	0.129	0.074	0.094	0.253	2.27E-07	0.066	0.024
Liver	0.017	0.054	0.029	0.037	0.085	6.25E-08	0.026	0.009
Thyroid	0.017	0.052	0.028	0.036	0.104	6.66E-08	0.029	0.010
Esophagus	0.008	0.025	0.011	0.014	0.043	1.23E-08	0.012	0.004
Skin	0.002	0.008	0.004	0.005	0.014	1.06E-08	0.004	0.001
Other	0.010	0.031	0.016	0.020	0.054	2.28E-08	0.016	0.005
Breast	0.035	0.103	0.065	0.080	0.228	2.22E-07	0.061	0.020
Total	0.534	1.647	0.850	1.075	2.949	1.62E-06	0.830	0.270

Table J.14 Effective Dose Contribution by Organ for Adipose Male Healthcare Provider from the Adipose Female Patient ($\mu\text{Sv/hr}$) /ALI

Organ	^{60}Co (s)	^{60}Co (m)	^{192}Ir (s)	^{192}Ir (m)	^{192}Ir (f)	^{241}Am	^{137}Cs	^{131}I
Gonads	0.088	0.270	0.140	0.174	0.365	2.90E-07	0.118	0.044
Stomach	0.113	0.338	0.181	0.233	0.706	3.88E-07	0.179	0.068
Colon Wall	0.116	0.364	0.169	0.212	0.573	2.30E-07	0.174	0.062
Bladder	0.081	0.255	0.119	0.151	0.387	1.56E-07	0.115	0.040
Lungs	0.033	0.101	0.055	0.071	0.188	1.22E-07	0.051	0.021
Bone	0.043	0.136	0.079	0.100	0.263	2.57E-07	0.068	0.028
Liver	0.018	0.057	0.032	0.040	0.087	7.48E-08	0.027	0.012
Thyroid	0.018	0.057	0.031	0.040	0.112	7.90E-08	0.028	0.013
Esophagus	0.009	0.027	0.013	0.016	0.046	1.96E-08	0.013	0.005
Skin	0.003	0.008	0.005	0.006	0.015	1.25E-08	0.004	0.002
Other	0.011	0.034	0.017	0.022	0.064	2.77E-08	0.018	0.007
Breast	0.031	0.103	0.075	0.099	0.233	2.89E-07	0.064	0.025
Total	0.563	1.751	0.915	1.164	3.038	1.95E-06	0.859	0.326

Table J.15 Effective Dose Contribution by Organ for Adipose Male Healthcare Provider from the Postmenopausal Adipose Female Patient ($\mu\text{Sv/hr}$) /ALI

Organ	^{60}Co (s)	^{60}Co (m)	^{192}Ir (s)	^{192}Ir (m)	^{192}Ir (f)	^{241}Am	^{137}Cs	^{131}I
Gonads	0.094	0.285	0.148	0.184	0.573	2.82E-07	0.196	0.041
Stomach	0.107	0.323	0.171	0.219	0.641	3.40E-07	0.271	0.057
Colon Wall	0.111	0.347	0.159	0.202	0.700	1.91E-07	0.279	0.053
Bladder	0.077	0.240	0.113	0.142	0.496	1.49E-07	0.183	0.034
Lungs	0.032	0.099	0.053	0.067	0.211	1.13E-07	0.078	0.018
Bone	0.042	0.132	0.076	0.096	0.310	2.33E-07	0.105	0.024
Liver	0.017	0.055	0.030	0.038	0.132	6.45E-08	0.041	0.010
Thyroid	0.017	0.051	0.028	0.036	0.119	7.49E-08	0.043	0.010
Esophagus	0.008	0.025	0.012	0.015	0.048	1.42E-08	0.020	0.004
Skin	0.003	0.008	0.004	0.005	0.018	1.14E-08	0.006	0.001
Other	0.010	0.032	0.016	0.020	0.066	2.44E-08	0.026	0.006
Breast	0.030	0.096	0.070	0.089	0.282	2.40E-07	0.086	0.021
Total	0.548	1.692	0.881	1.114	3.596	1.74E-06	1.334	0.279

Table J.16 Effective Dose Contribution by Organ for Adipose Female Healthcare Provider from the Reference Male Patient ($\mu\text{Sv/hr}$) /ALI

Organ	^{60}Co (s)	^{60}Co (m)	^{192}Ir (s)	^{192}Ir (m)	^{192}Ir (f)	^{241}Am	^{137}Cs	^{131}I
Gonads	0.053	0.167	0.091	0.105	0.237	9.27E-08	0.070	0.024
Stomach	0.117	0.349	0.222	0.254	0.673	4.93E-07	0.176	0.066
Colon Wall	0.110	0.342	0.186	0.217	0.554	2.84E-07	0.166	0.057
Bladder	0.091	0.279	0.153	0.180	0.459	2.43E-07	0.132	0.046
Lungs	0.039	0.118	0.070	0.085	0.196	1.72E-07	0.056	0.022
Bone	0.050	0.156	0.099	0.119	0.288	3.82E-07	0.075	0.029
Liver	0.021	0.065	0.040	0.049	0.099	1.07E-07	0.030	0.012
Thyroid	0.020	0.062	0.040	0.049	0.121	1.35E-07	0.029	0.012
Esophagus	0.012	0.039	0.019	0.023	0.062	2.99E-08	0.017	0.006
Skin	0.004	0.014	0.008	0.010	0.024	2.40E-08	0.007	0.002
Other	0.015	0.044	0.025	0.030	0.070	4.41E-08	0.022	0.008
Breast	0.078	0.238	0.164	0.199	0.453	6.09E-07	0.117	0.048
Total	0.610	1.871	1.119	1.322	3.236	2.62E-06	0.895	0.333

Table J.17 Effective Dose Contribution by Organ for Adipose Female Healthcare Provider from the Reference Female Patient ($\mu\text{Sv/hr}$) /ALI

Organ	^{60}Co (s)	^{60}Co (m)	^{192}Ir (s)	^{192}Ir (m)	^{192}Ir (f)	^{241}Am	^{137}Cs	^{131}I
Gonads	0.054	0.172	0.079	0.102	0.253	1.44E-07	0.079	0.027
Stomach	0.125	0.373	0.224	0.283	0.738	5.75E-07	0.168	0.067
Colon Wall	0.117	0.368	0.182	0.230	0.568	3.19E-07	0.188	0.057
Bladder	0.095	0.296	0.152	0.191	0.456	2.45E-07	0.155	0.044
Lungs	0.040	0.123	0.071	0.089	0.210	1.83E-07	0.064	0.022
Bone	0.051	0.157	0.095	0.120	0.293	3.90E-07	0.083	0.029
Liver	0.022	0.068	0.042	0.052	0.104	1.16E-07	0.043	0.013
Thyroid	0.020	0.061	0.039	0.050	0.123	1.23E-07	0.032	0.013
Esophagus	0.013	0.040	0.021	0.026	0.064	3.70E-08	0.020	0.007
Skin	0.005	0.014	0.008	0.010	0.025	2.58E-08	0.008	0.002
Other	0.016	0.047	0.025	0.032	0.077	4.83E-08	0.023	0.008
Breast	0.080	0.245	0.165	0.207	0.483	6.52E-07	0.136	0.050
Total	0.636	1.964	1.102	1.393	3.394	2.86E-06	0.999	0.339

Table J.18 Effective Dose Contribution by Organ for Adipose Female Healthcare Provider from the Adipose Male Patient ($\mu\text{Sv/hr}$) /ALI

Organ	^{60}Co (s)	^{60}Co (m)	^{192}Ir (s)	^{192}Ir (m)	^{192}Ir (f)	^{241}Am	^{137}Cs	^{131}I
Gonads	0.049	0.153	0.070	0.090	0.247	7.74E-08	0.078	0.022
Stomach	0.109	0.329	0.182	0.234	0.713	3.94E-07	0.181	0.059
Colon Wall	0.103	0.321	0.157	0.200	0.562	2.20E-07	0.166	0.051
Bladder	0.084	0.263	0.129	0.163	0.447	1.79E-07	0.129	0.040
Lungs	0.034	0.105	0.057	0.072	0.193	1.22E-07	0.055	0.019
Bone	0.046	0.142	0.083	0.105	0.282	2.72E-07	0.073	0.026
Liver	0.019	0.061	0.035	0.044	0.104	8.30E-08	0.031	0.011
Thyroid	0.018	0.053	0.028	0.036	0.116	7.42E-08	0.029	0.011
Esophagus	0.011	0.034	0.016	0.020	0.058	2.38E-08	0.017	0.006
Skin	0.004	0.013	0.007	0.009	0.024	1.81E-08	0.007	0.002
Other	0.014	0.041	0.021	0.026	0.071	3.25E-08	0.021	0.007
Breast	0.068	0.212	0.132	0.168	0.453	4.24E-07	0.117	0.042
Total	0.559	1.728	0.918	1.167	3.270	1.92E-06	0.904	0.297

Table J.19 Effective Dose Contribution by Organ for Adipose Female Healthcare Provider from the Adipose Female Patient ($\mu\text{Sv/hr}$) /ALI

Organ	^{60}Co (s)	^{60}Co (m)	^{192}Ir (s)	^{192}Ir (m)	^{192}Ir (f)	^{241}Am	^{137}Cs	^{131}I
Gonads	0.037	0.156	0.079	0.099	0.318	1.36E-07	0.073	0.024
Stomach	0.086	0.358	0.211	0.269	0.798	5.06E-07	0.195	0.067
Colon Wall	0.081	0.352	0.171	0.217	0.732	2.57E-07	0.170	0.055
Bladder	0.066	0.287	0.141	0.177	0.600	2.12E-07	0.130	0.042
Lungs	0.026	0.113	0.063	0.080	0.250	1.46E-07	0.057	0.021
Bone	0.034	0.149	0.088	0.111	0.353	3.11E-07	0.075	0.028
Liver	0.015	0.066	0.039	0.049	0.166	9.90E-08	0.032	0.012
Thyroid	0.012	0.052	0.032	0.040	0.121	9.41E-08	0.030	0.012
Esophagus	0.009	0.037	0.018	0.022	0.073	2.69E-08	0.019	0.006
Skin	0.003	0.014	0.008	0.010	0.031	2.16E-08	0.007	0.002
Other	0.010	0.046	0.022	0.029	0.091	4.01E-08	0.022	0.008
Breast	0.053	0.226	0.147	0.186	0.589	5.09E-07	0.122	0.046
Total	0.433	1.854	1.019	1.289	4.123	2.36E-06	0.931	0.322

Table J.20 Effective Dose Contribution by Organ for Adipose Female Healthcare Provider from the Postmenopausal Adipose Female Patient ($\mu\text{Sv/hr}$) /ALI

Organ	^{60}Co (s)	^{60}Co (m)	^{192}Ir (s)	^{192}Ir (m)	^{192}Ir (f)	^{241}Am	^{137}Cs	^{131}I
Gonads	0.037	0.162	0.075	0.092	0.235	1.07E-07	0.125	0.023
Stomach	0.083	0.345	0.199	0.254	0.736	4.47E-07	0.287	0.062
Colon Wall	0.078	0.340	0.163	0.208	0.563	2.41E-07	0.277	0.053
Bladder	0.062	0.272	0.136	0.172	0.437	2.02E-07	0.212	0.041
Lungs	0.025	0.110	0.060	0.075	0.197	1.31E-07	0.086	0.020
Bone	0.033	0.145	0.085	0.107	0.282	2.83E-07	0.116	0.027
Liver	0.014	0.063	0.037	0.046	0.102	8.80E-08	0.047	0.011
Thyroid	0.012	0.052	0.032	0.040	0.113	8.50E-08	0.046	0.011
Esophagus	0.008	0.034	0.017	0.022	0.057	2.07E-08	0.027	0.006
Skin	0.003	0.013	0.007	0.009	0.024	1.93E-08	0.010	0.002
Other	0.010	0.045	0.021	0.026	0.075	3.55E-08	0.034	0.007
Breast	0.051	0.220	0.140	0.177	0.455	4.59E-07	0.175	0.044
Total	0.418	1.799	0.972	1.230	3.275	2.12E-06	1.442	0.306

Table J.21 Effective Dose Contribution by Organ for Postmenopausal Adipose Female
Healthcare Provider from the Reference Male Patient ($\mu\text{Sv/hr}$) /ALI

Organ	^{60}Co (s)	^{60}Co (m)	^{192}Ir (s)	^{192}Ir (m)	^{192}Ir (f)	^{241}Am	^{137}Cs	^{131}I
Gonads	0.073	0.303	0.156	0.175	0.448	1.84E-07	0.145	0.049
Stomach	0.076	0.318	0.197	0.223	0.613	4.25E-07	0.156	0.059
Colon Wall	0.073	0.316	0.165	0.193	0.484	2.20E-07	0.149	0.052
Bladder	0.059	0.254	0.134	0.156	0.398	1.87E-07	0.116	0.040
Lungs	0.027	0.115	0.067	0.081	0.189	1.55E-07	0.053	0.020
Bone	0.035	0.151	0.097	0.116	0.281	3.50E-07	0.073	0.029
Liver	0.014	0.063	0.037	0.045	0.089	9.28E-08	0.028	0.011
Thyroid	0.020	0.086	0.053	0.066	0.165	1.72E-07	0.042	0.017
Esophagus	0.009	0.039	0.019	0.023	0.058	2.61E-08	0.016	0.006
Skin	0.003	0.013	0.008	0.009	0.022	2.18E-08	0.006	0.002
Other	0.010	0.042	0.024	0.028	0.066	3.82E-08	0.021	0.007
Breast	0.052	0.221	0.154	0.187	0.423	5.75E-07	0.109	0.045
Total	0.452	1.921	1.110	1.302	3.237	2.45E-06	0.914	0.337

Table J.22 Effective Dose Contribution by Organ for Postmenopausal Adipose Female
Healthcare Provider from the Reference Female Patient ($\mu\text{Sv/hr}$) /ALI

Organ	^{60}Co (s)	^{60}Co (m)	^{192}Ir (s)	^{192}Ir (m)	^{192}Ir (f)	^{241}Am	^{137}Cs	^{131}I
Gonads	0.116	0.353	0.150	0.191	0.472	1.64E-07	0.169	0.041
Stomach	0.115	0.345	0.196	0.248	0.667	4.93E-07	0.146	0.060
Colon Wall	0.107	0.335	0.162	0.204	0.506	2.51E-07	0.168	0.050
Bladder	0.085	0.267	0.128	0.161	0.394	1.86E-07	0.136	0.038
Lungs	0.038	0.119	0.067	0.085	0.200	1.67E-07	0.062	0.022
Bone	0.049	0.153	0.093	0.117	0.285	3.55E-07	0.081	0.028
Liver	0.021	0.065	0.038	0.048	0.094	1.00E-07	0.041	0.012
Thyroid	0.029	0.086	0.054	0.067	0.167	1.69E-07	0.045	0.018
Esophagus	0.012	0.040	0.019	0.024	0.062	3.15E-08	0.018	0.006
Skin	0.004	0.013	0.007	0.009	0.022	2.36E-08	0.007	0.002
Other	0.014	0.043	0.022	0.029	0.069	3.99E-08	0.022	0.008
Breast	0.075	0.229	0.154	0.194	0.451	6.20E-07	0.127	0.046
Total	0.667	2.048	1.091	1.377	3.390	2.60E-06	1.022	0.333

Table J.23 Effective Dose Contribution by Organ for Postmenopausal Adipose Female
Healthcare Provider from the Adipose Male Patient ($\mu\text{Sv/hr}$) /ALI

Organ	^{60}Co (s)	^{60}Co (m)	^{192}Ir (s)	^{192}Ir (m)	^{192}Ir (f)	^{241}Am	^{137}Cs	^{131}I
Gonads	0.094	0.303	0.120	0.155	0.456	1.40E-07	0.135	0.044
Stomach	0.099	0.296	0.162	0.208	0.644	3.20E-07	0.161	0.053
Colon Wall	0.093	0.296	0.138	0.175	0.494	1.72E-07	0.148	0.046
Bladder	0.075	0.235	0.111	0.141	0.387	1.43E-07	0.110	0.034
Lungs	0.033	0.102	0.054	0.069	0.185	1.10E-07	0.053	0.018
Bone	0.044	0.137	0.080	0.102	0.273	2.47E-07	0.071	0.026
Liver	0.018	0.059	0.033	0.041	0.095	7.15E-08	0.029	0.010
Thyroid	0.025	0.075	0.042	0.052	0.159	9.83E-08	0.042	0.016
Esophagus	0.010	0.031	0.016	0.020	0.056	1.95E-08	0.016	0.005
Skin	0.004	0.011	0.006	0.008	0.022	1.64E-08	0.006	0.002
Other	0.013	0.040	0.019	0.024	0.068	2.67E-08	0.019	0.012
Breast	0.064	0.198	0.124	0.157	0.425	3.97E-07	0.109	0.040
Total	0.571	1.784	0.905	1.151	3.263	1.76E-06	0.899	0.306

Table J.24 Effective Dose Contribution by Organ for Postmenopausal Adipose Female
Healthcare Provider from the Adipose Female Patient ($\mu\text{Sv/hr}$) /ALI

Organ	^{60}Co (s)	^{60}Co (m)	^{192}Ir (s)	^{192}Ir (m)	^{192}Ir (f)	^{241}Am	^{137}Cs	^{131}I
Gonads	0.102	0.325	0.139	0.173	0.585	1.55E-07	0.149	0.047
Stomach	0.110	0.331	0.185	0.236	0.689	4.10E-07	0.176	0.060
Colon Wall	0.101	0.316	0.150	0.190	0.645	1.99E-07	0.152	0.050
Bladder	0.082	0.256	0.121	0.152	0.513	1.55E-07	0.118	0.037
Lungs	0.036	0.110	0.061	0.077	0.241	1.37E-07	0.055	0.020
Bone	0.046	0.145	0.085	0.108	0.343	2.82E-07	0.073	0.027
Liver	0.020	0.062	0.036	0.045	0.153	8.43E-08	0.030	0.011
Thyroid	0.025	0.078	0.043	0.054	0.167	1.17E-07	0.042	0.016
Esophagus	0.012	0.036	0.016	0.020	0.064	2.83E-08	0.016	0.006
Skin	0.004	0.012	0.007	0.009	0.029	1.99E-08	0.006	0.002
Other	0.014	0.043	0.021	0.027	0.088	3.44E-08	0.020	0.007
Breast	0.068	0.211	0.138	0.174	0.552	4.82E-07	0.114	0.043
Total	0.620	1.926	1.002	1.265	4.067	2.10E-06	0.951	0.327

Table J.25 Effective Dose Contribution by Organ for Postmenopausal Adipose Female
Healthcare Provider from the Postmenopausal Adipose Female Patient ($\mu\text{Sv/hr}$) /ALI

Organ	⁶⁰ Co (s)	⁶⁰ Co (m)	¹⁹² Ir (s)	¹⁹² Ir (m)	¹⁹² Ir (f)	²⁴¹ Am	¹³⁷ Cs	¹³¹ I
Gonads	0.101	0.315	0.136	0.173	0.417	1.25E-07	0.243	0.041
Stomach	0.105	0.316	0.174	0.221	0.663	3.60E-07	0.259	0.057
Colon Wall	0.098	0.308	0.143	0.180	0.501	1.85E-07	0.249	0.047
Bladder	0.078	0.244	0.116	0.145	0.366	1.52E-07	0.186	0.035
Lungs	0.034	0.107	0.057	0.072	0.188	1.17E-07	0.084	0.019
Bone	0.045	0.140	0.082	0.104	0.273	2.55E-07	0.112	0.026
Liver	0.019	0.060	0.034	0.043	0.093	7.50E-08	0.045	0.011
Thyroid	0.024	0.074	0.042	0.053	0.150	1.10E-07	0.064	0.015
Esophagus	0.011	0.035	0.016	0.020	0.059	2.12E-08	0.026	0.005
Skin	0.004	0.012	0.007	0.008	0.022	1.78E-08	0.009	0.002
Other	0.013	0.040	0.019	0.024	0.067	2.87E-08	0.031	0.006
Breast	0.066	0.204	0.131	0.166	0.425	4.31E-07	0.162	0.041
Total	0.599	1.855	0.955	1.211	3.224	1.88E-06	1.470	0.305

APPENDIX K

ABSORB DOSE TO PATIENT

Table K.1 Absorbed Dose to Organs for Reference Male Patient for 37 GBq/m² Surface Contamination (mGy/hr)

Organ	⁶⁰ Co	¹⁹² Ir	²⁴¹ Am	¹³⁷ Cs	¹³¹ I
Gonads	1.55E+02	6.13E+01	2.93E+00	3.95E+01	2.30E+01
Stomach	2.61E+02	9.61E+01	2.26E+00	6.29E+01	3.61E+01
Colon Wall	3.36E+02	1.25E+02	2.77E+00	8.15E+01	4.69E+01
Bladder	4.87E+02	1.84E+02	4.50E+00	1.19E+02	6.89E+01
Lungs	1.08E+02	4.13E+01	1.06E+00	2.67E+01	1.55E+01
Bone	1.83E+02	7.56E+01	5.14E+00	4.58E+01	2.75E+01
Liver	9.98E+01	3.70E+01	8.67E-01	2.42E+01	1.39E+01
Thyroid	2.02E+02	7.76E+01	2.36E+00	5.03E+01	2.92E+01
Esophagus	9.38E+01	3.52E+01	6.88E-01	2.30E+01	1.33E+01
Skin	1.33E+02	6.53E+01	1.07E+01	4.00E+01	2.46E+01
Other	1.20E+02	4.58E+01	1.04E+00	2.98E+01	1.71E+01
Total	2.18E+03	8.44E+02	3.43E+01	5.42E+02	3.16E+02

Table K.2 Absorbed Dose to Organs for Reference Female Patient for 37 GBq/m² Surface Contamination (mGy/hr)

Organ	⁶⁰ Co	¹⁹² Ir	²⁴¹ Am	¹³⁷ Cs	¹³¹ I
Gonads	7.19E+01	2.67E+01	5.41E-01	1.74E+01	1.01E+01
Stomach	2.05E+02	7.63E+01	1.87E+00	4.98E+01	2.87E+01
Colon Wall	2.57E+02	9.57E+01	2.22E+00	6.20E+01	3.58E+01
Bladder	4.43E+02	1.67E+02	4.17E+00	1.08E+02	6.26E+01
Lungs	9.45E+01	3.64E+01	9.49E-01	2.33E+01	1.36E+01
Bone	1.88E+02	7.85E+01	5.22E+00	4.75E+01	2.85E+01
Liver	8.81E+01	3.30E+01	7.89E-01	2.15E+01	1.24E+01
Thyroid	1.41E+02	5.44E+01	1.73E+00	3.55E+01	2.05E+01
Esophagus	9.96E+01	3.81E+01	7.62E-01	2.45E+01	1.43E+01
Skin	1.80E+02	8.78E+01	1.40E+01	5.38E+01	3.31E+01
Other	1.00E+02	3.81E+01	8.66E-01	2.47E+01	1.42E+01
Breasts	3.21E+02	1.27E+02	7.37E+00	8.15E+01	4.81E+01
Total	2.19E+03	8.59E+02	4.05E+01	5.49E+02	3.22E+02

Table K.3 Absorbed Dose to Organs for Adipose Male Patient for 37 GBq/m² Surface Contamination (mGy/hr)

Organ	⁶⁰Co	¹⁹²Ir	²⁴¹Am	¹³⁷Cs	¹³¹I
Gonads	2.21E+02	8.94E+01	4.47E+00	5.64E+01	3.35E+01
Stomach	2.00E+02	7.47E+01	1.62E+00	4.82E+01	2.79E+01
Colon	2.76E+02	1.01E+02	1.99E+00	6.55E+01	3.77E+01
Bladder	4.08E+02	1.53E+02	3.13E+00	9.79E+01	5.69E+01
Lungs	9.00E+01	3.48E+01	8.33E-01	2.22E+01	1.30E+01
Bone	2.14E+02	9.14E+01	4.98E+00	5.39E+01	3.28E+01
Liver	7.50E+01	2.78E+01	5.98E-01	1.80E+01	1.04E+01
Thyroid	2.27E+02	8.97E+01	2.79E+00	5.74E+01	3.35E+01
Esophagus	8.88E+01	3.36E+01	6.51E-01	2.16E+01	1.25E+01
Skin	1.76E+02	8.42E+01	1.32E+01	5.18E+01	3.17E+01
Other	1.13E+02	4.26E+01	1.03E+00	2.76E+01	1.60E+01
Breasts	2.42E+02	9.65E+01	6.56E+00	6.23E+01	3.66E+01
Total	2.33E+03	9.19E+02	4.19E+01	5.83E+02	3.43E+02

Table K.4 Absorbed Dose to Organs for Adipose Female Patient for 37 GBq/m² Surface Contamination (mGy/hr)

Organ	⁶⁰Co	¹⁹²Ir	²⁴¹Am	¹³⁷Cs	¹³¹I
Gonads	7.08E+04	2.62E+04	4.71E+02	1.68E+04	9.80E+03
Stomach	2.09E+05	7.88E+04	1.84E+03	5.09E+04	2.95E+04
Colon Wall	2.47E+05	9.19E+04	1.96E+03	5.93E+04	3.43E+04
Bladder	4.02E+05	1.51E+05	3.23E+03	9.70E+04	5.63E+04
Lungs	9.89E+04	3.83E+04	9.51E+02	2.45E+04	1.43E+04
Bone	1.92E+05	8.11E+04	4.70E+03	4.82E+04	2.92E+04
Liver	8.94E+04	3.36E+04	7.67E+02	2.17E+04	1.25E+04
Thyroid	1.68E+05	6.48E+04	2.06E+03	4.19E+04	2.45E+04
Esophagus	1.10E+05	4.19E+04	8.25E+02	2.67E+04	1.56E+04
Skin	2.12E+05	1.03E+05	1.61E+04	6.29E+04	3.86E+04
Other	1.09E+05	4.11E+04	8.77E+02	2.67E+04	1.55E+04
Breast	4.29E+05	1.70E+05	9.59E+03	1.09E+05	6.43E+04
Total	2.34E+06	9.22E+05	4.34E+04	5.86E+05	3.44E+05

Table K.5 Absorbed Dose to Organs for Postmenopausal Adipose Female Patient for 37 GBq/m² Surface Contamination (mGy/hr)

Organ	⁶⁰ Co	¹⁹² Ir	²⁴¹ Am	¹³⁷ Cs	¹³¹ I
Gonads	1.35E+02	5.14E+01	7.72E-01	3.19E+01	1.87E+01
Stomach	1.87E+02	7.06E+01	1.60E+00	4.53E+01	2.64E+01
Colon Wall	2.23E+02	8.25E+01	1.75E+00	5.35E+01	3.10E+01
Bladder	3.66E+02	1.38E+02	2.95E+00	8.83E+01	5.14E+01
Lungs	9.38E+01	3.64E+01	8.77E-01	2.32E+01	1.36E+01
Bone	1.88E+02	8.05E+01	4.50E+00	4.72E+01	2.88E+01
Liver	8.08E+01	3.03E+01	6.65E-01	1.95E+01	1.13E+01
Thyroid	2.75E+02	1.07E+02	3.45E+00	6.86E+01	4.02E+01
Esophagus	1.09E+02	4.20E+01	8.07E-01	2.66E+01	1.54E+01
Skin	1.87E+02	9.11E+01	1.45E+01	5.57E+01	3.42E+01
Other	1.06E+02	4.02E+01	8.43E-01	2.61E+01	1.50E+01
Breast	4.03E+02	1.61E+02	9.33E+00	1.03E+02	6.07E+01
Total	2.35E+03	9.31E+02	4.20E+01	5.89E+02	3.47E+02

APPENDIX L

ABSORBED DOSE TO ORGANS FOR HEALTHCARE PROVIDER DUE TO EXTERNALLY CONTAMINATED PATIENT

Table L.1 Absorbed Dose to Organs for a Reference Male Healthcare Provider from Reference Male Patient for 37GBq/m² Surface Contamination (mGy/hr)

Organ	⁶⁰ Co	¹⁹² Ir	²⁴¹ Am	¹³⁷ Cs	¹³¹ I
Gonads	2.58E+00	8.77E-01	1.46E-02	5.95E-01	3.17E-01
Stomach	6.61E+00	3.07E+00	9.27E-02	1.75E+00	1.12E+00
Colon Wall	8.56E+00	3.76E+00	9.81E-02	2.19E+00	1.38E+00
Bladder	5.41E+00	2.35E+00	6.58E-02	1.38E+00	8.51E-01
Lungs	1.59E+00	6.61E-01	1.80E-02	4.05E-01	2.44E-01
Bone	2.13E+00	8.99E-01	4.69E-02	5.26E-01	3.22E-01
Liver	8.97E-01	3.96E-01	1.13E-02	2.34E-01	1.46E-01
Thyroid	9.09E-01	3.85E-01	1.10E-02	2.34E-01	1.43E-01
Esophagus	4.54E-01	1.65E-01	2.81E-03	1.03E-01	6.25E-02
Skin	9.98E-02	4.24E-02	5.15E-03	2.61E-02	1.57E-02
Other	1.43E+00	6.04E-01	1.43E-02	3.59E-01	2.18E-01
Total	3.07E+01	1.32E+01	3.81E-01	7.80E+00	4.81E+00

Table L.2 Absorbed Dose to Organs for a Reference Male Healthcare Provider from Reference Female Patient for 37GBq/m² Surface Contamination (mGy/hr)

Organ	⁶⁰ Co	¹⁹² Ir	²⁴¹ Am	¹³⁷ Cs	¹³¹ I
Gonads	1.02E+01	3.32E+00	5.72E-02	2.36E+00	1.20E+00
Stomach	4.64E+01	2.17E+01	6.61E-01	1.24E+01	7.92E+00
Colon Wall	5.96E+01	2.60E+01	6.82E-01	1.53E+01	9.43E+00
Bladder	9.07E+01	3.84E+01	1.09E+00	2.31E+01	1.42E+01
Lungs	1.13E+01	4.76E+00	1.26E-01	2.89E+00	1.75E+00
Bone	1.40E+01	5.88E+00	3.04E-01	3.44E+00	2.11E+00
Liver	1.46E+01	6.39E+00	1.78E-01	3.77E+00	2.34E+00
Thyroid	1.46E+01	6.62E+00	2.04E-01	3.98E+00	2.42E+00
Esophagus	7.45E+00	2.73E+00	4.59E-02	1.81E+00	9.99E-01
Skin	8.39E+00	3.52E+00	4.16E-01	2.19E+00	1.32E+00
Other	1.19E+01	5.08E+00	1.19E-01	3.10E+00	1.88E+00
Total	2.89E+02	1.24E+02	3.88E+00	7.43E+01	4.56E+01

Table L.3 Absorbed Dose to Organs for a Reference Male Healthcare Provider from Adipose Male Patient for 37GBq/m² Surface Contamination (mGy/hr)

Organ	⁶⁰ Co	¹⁹² Ir	²⁴¹ Am	¹³⁷ Cs	¹³¹ I
Gonads	1.38E+01	4.54E+00	8.74E-02	3.16E+00	1.68E+00
Stomach	5.69E+01	2.54E+01	7.21E-01	1.49E+01	9.30E+00
Colon Wall	7.39E+01	3.08E+01	7.52E-01	1.84E+01	1.13E+01
Bladder	1.23E+02	5.14E+01	1.40E+00	3.12E+01	1.90E+01
Lungs	1.45E+01	5.89E+00	1.50E-01	3.63E+00	2.16E+00
Bone	1.87E+01	7.65E+00	3.85E-01	4.52E+00	2.74E+00
Liver	1.74E+01	7.31E+00	1.93E-01	4.40E+00	2.69E+00
Thyroid	2.02E+01	8.83E+00	2.67E-01	5.34E+00	3.19E+00
Esophagus	1.02E+01	3.44E+00	6.02E-02	2.22E+00	1.30E+00
Skin	1.09E+01	4.40E+00	4.73E-01	2.77E+00	1.64E+00
Other	1.49E+01	5.85E+00	1.42E-01	3.80E+00	2.28E+00
Total	3.74E+02	1.55E+02	4.63E+00	9.43E+01	5.73E+01

Table L.4 Absorbed Dose to Organs for a Reference Male Healthcare Provider from Adipose Female Patient for 37GBq/m² Surface Contamination (mGy/hr)

Organ	⁶⁰ Co	¹⁹² Ir	²⁴¹ Am	¹³⁷ Cs	¹³¹ I
Gonads	4.18E-01	3.03E-01	2.06E-01	3.79E-01	3.40E-01
Stomach	1.83E+00	1.96E+00	2.09E+00	1.88E+00	1.94E+00
Colon Wall	2.28E+00	2.36E+00	2.09E+00	2.32E+00	2.32E+00
Bladder	3.44E+00	3.53E+00	3.44E+00	3.49E+00	3.56E+00
Lungs	4.41E-01	4.38E-01	4.04E-01	4.45E-01	4.37E-01
Bone	5.45E-01	5.38E-01	9.67E-01	5.25E-01	5.24E-01
Liver	5.59E-01	5.68E-01	5.45E-01	5.63E-01	5.69E-01
Thyroid	6.60E-01	6.36E-01	5.87E-01	6.55E-01	6.23E-01
Esophagus	3.03E-01	2.69E-01	1.59E-01	2.81E-01	2.70E-01
Skin	3.28E-01	3.22E-01	1.28E+00	3.34E-01	3.26E-01
Other	4.73E-01	4.51E-01	3.43E-01	4.60E-01	4.60E-01
Total	1.13E+01	1.14E+01	1.21E+01	1.13E+01	1.14E+01

Table L.5 Absorbed Dose to Organs for a Reference Male Healthcare Provider from Postmenopausal Adipose Female Patient for 37GBq/m² Surface Contamination (mGy/hr)

Organ	⁶⁰Co	¹⁹²Ir	²⁴¹Am	¹³⁷Cs	¹³¹I
Gonads	1.29E+01	4.23E+00	8.02E-02	2.94E+00	1.58E+00
Stomach	5.40E+01	2.45E+01	7.33E-01	1.42E+01	8.85E+00
Colon Wall	6.92E+01	2.98E+01	7.53E-01	1.78E+01	1.09E+01
Bladder	1.12E+02	4.76E+01	1.30E+00	2.89E+01	1.76E+01
Lungs	1.36E+01	5.54E+00	1.46E-01	3.40E+00	2.04E+00
Bone	1.69E+01	7.05E+00	3.62E-01	4.14E+00	2.53E+00
Liver	1.67E+01	7.16E+00	1.96E-01	4.27E+00	2.63E+00
Thyroid	1.91E+01	8.02E+00	2.28E-01	5.00E+00	3.05E+00
Esophagus	9.03E+00	3.28E+00	6.26E-02	2.13E+00	1.25E+00
Skin	1.00E+01	4.14E+00	4.63E-01	2.60E+00	1.54E+00
Other	1.45E+01	5.88E+00	1.41E-01	3.51E+00	2.13E+00
Total	3.48E+02	1.47E+02	4.46E+00	8.88E+01	5.41E+01

Table L.6 Absorbed Dose to Organs for a Reference Female Healthcare Provider from Reference Male Patient for 37GBq/m² Surface Contamination (mGy/hr)

Organ	Co-60	Ir-192	Am-241	Cs-137	I-131
Gonads	1.79E+01	7.73E+00	1.69E-01	4.72E+00	2.73E+00
Stomach	5.14E+01	2.42E+01	7.67E-01	1.37E+01	8.79E+00
Colon Wall	6.05E+01	2.68E+01	6.97E-01	1.57E+01	9.82E+00
Bladder	1.05E+02	4.49E+01	1.25E+00	2.65E+01	1.64E+01
Lungs	1.41E+01	5.82E+00	1.51E-01	3.54E+00	2.14E+00
Bone	1.75E+01	7.38E+00	3.72E-01	4.32E+00	2.65E+00
Liver	1.93E+01	8.60E+00	2.48E-01	5.04E+00	3.15E+00
Thyroid	1.61E+01	6.99E+00	2.19E-01	4.35E+00	2.60E+00
Esophagus	1.10E+01	4.09E+00	6.74E-02	2.60E+00	1.58E+00
Skin	1.52E+01	6.33E+00	6.99E-01	3.93E+00	2.35E+00
Other	1.59E+01	6.64E+00	1.49E-01	4.06E+00	2.33E+00
Breasts	5.25E+01	2.39E+01	1.40E+00	1.40E+01	8.77E+00
Total	3.97E+02	1.73E+02	6.18E+00	1.02E+02	6.33E+01

Table L.7 Absorbed Dose to Organs for a Reference Female Healthcare Provider from Reference Female Patient for 37GBq/m² Surface Contamination (mGy/hr)

Organ	⁶⁰Co	¹⁹²Ir	²⁴¹Am	¹³⁷Cs	¹³¹I
Gonads	1.58E+01	6.17E+00	1.42E-01	4.07E+00	2.37E+00
Stomach	4.32E+01	2.04E+01	6.46E-01	1.17E+01	7.42E+00
Colon Wall	5.06E+01	2.21E+01	5.65E-01	1.30E+01	8.08E+00
Bladder	8.88E+01	3.73E+01	1.03E+00	2.26E+01	1.38E+01
Lungs	1.19E+01	4.93E+00	1.27E-01	3.02E+00	1.82E+00
Bone	1.49E+01	6.26E+00	3.15E-01	3.67E+00	2.24E+00
Liver	1.54E+01	6.89E+00	1.94E-01	4.03E+00	2.51E+00
Thyroid	1.44E+01	5.98E+00	2.06E-01	3.75E+00	2.23E+00
Esophagus	9.84E+00	3.79E+00	6.43E-02	2.43E+00	1.39E+00
Skin	1.28E+01	5.25E+00	5.66E-01	3.31E+00	1.97E+00
Other	1.27E+01	5.45E+00	1.33E-01	3.30E+00	1.99E+00
Breasts	4.46E+01	2.00E+01	1.14E+00	1.19E+01	7.39E+00
Total	3.35E+02	1.45E+02	5.13E+00	8.67E+01	5.32E+01

Table L.8 Absorbed Dose to Organs for a Reference Female Healthcare Provider from Adipose Male Patient for 37GBq/m² Surface Contamination (mGy/hr)

Organ	⁶⁰Co	¹⁹²Ir	²⁴¹Am	¹³⁷Cs	¹³¹I
Gonads	1.81E+01	7.58E+00	1.75E-01	4.69E+00	2.80E+00
Stomach	5.19E+01	2.36E+01	7.10E-01	1.36E+01	8.65E+00
Colon Wall	6.25E+01	2.63E+01	6.39E-01	1.58E+01	9.64E+00
Bladder	1.21E+02	5.03E+01	1.33E+00	3.06E+01	1.87E+01
Lungs	1.51E+01	6.08E+00	1.50E-01	3.79E+00	2.23E+00
Bone	1.98E+01	8.10E+00	3.96E-01	4.80E+00	2.91E+00
Liver	1.85E+01	7.78E+00	2.10E-01	4.68E+00	2.85E+00
Thyroid	1.85E+01	7.74E+00	2.63E-01	4.66E+00	3.01E+00
Esophagus	1.25E+01	4.46E+00	7.15E-02	3.17E+00	1.69E+00
Skin	1.66E+01	6.54E+00	6.43E-01	4.18E+00	2.45E+00
Other	1.63E+01	6.75E+00	1.46E-01	4.13E+00	2.41E+00
Breasts	5.52E+01	2.40E+01	1.28E+00	1.44E+01	8.81E+00
Total	4.26E+02	1.79E+02	6.01E+00	1.09E+02	6.62E+01

Table L.9 Absorbed Dose to Organs for a Reference Female Healthcare Provider from Adipose Female Patient for 37GBq/m² Surface Contamination (mGy/hr)

Organ	⁶⁰ Co	¹⁹² Ir	²⁴¹ Am	¹³⁷ Cs	¹³¹ I
Gonads	1.77E+01	7.27E+00	1.76E-01	4.33E+00	2.85E+00
Stomach	5.28E+01	2.46E+01	7.74E-01	1.41E+01	8.90E+00
Colon Wall	6.17E+01	2.70E+01	6.82E-01	1.59E+01	9.83E+00
Bladder	1.04E+02	4.49E+01	1.24E+00	2.68E+01	1.66E+01
Lungs	1.45E+01	5.95E+00	1.52E-01	3.65E+00	2.19E+00
Bone	1.81E+01	7.60E+00	3.85E-01	4.44E+00	2.72E+00
Liver	1.87E+01	8.18E+00	2.33E-01	4.82E+00	3.00E+00
Thyroid	1.83E+01	7.43E+00	2.56E-01	4.62E+00	2.84E+00
Esophagus	1.14E+01	4.17E+00	7.78E-02	2.75E+00	1.58E+00
Skin	1.55E+01	6.38E+00	6.75E-01	4.00E+00	2.37E+00
Other	1.55E+01	6.36E+00	1.51E-01	3.91E+00	2.37E+00
Breasts	5.44E+01	2.43E+01	1.36E+00	1.44E+01	8.95E+00
Total	4.02E+02	1.74E+02	6.16E+00	1.04E+02	6.42E+01

Table L.10 Absorbed Dose to Organs for a Reference Female Healthcare Provider from Postmenopausal Adipose Female Patient for 37GBq/m² Surface Contamination (mGy/hr)

Organ	⁶⁰ Co	¹⁹² Ir	²⁴¹ Am	¹³⁷ Cs	¹³¹ I
Gonads	1.75E+01	7.12E+00	1.69E-01	4.46E+00	2.72E+00
Stomach	5.05E+01	2.30E+01	7.21E-01	1.34E+01	8.34E+00
Colon Wall	5.99E+01	2.56E+01	6.41E-01	1.55E+01	9.37E+00
Bladder	1.09E+02	4.62E+01	1.25E+00	2.79E+01	1.71E+01
Lungs	1.40E+01	5.66E+00	1.42E-01	3.50E+00	2.09E+00
Bone	1.80E+01	7.48E+00	3.71E-01	4.40E+00	2.68E+00
Liver	1.76E+01	7.71E+00	2.14E-01	4.56E+00	2.83E+00
Thyroid	1.76E+01	7.30E+00	2.34E-01	4.71E+00	2.68E+00
Esophagus	1.18E+01	4.26E+00	7.67E-02	2.89E+00	1.58E+00
Skin	1.52E+01	6.18E+00	6.31E-01	3.90E+00	2.30E+00
Other	1.46E+01	6.36E+00	1.47E-01	3.80E+00	2.30E+00
Breasts	5.17E+01	2.30E+01	1.25E+00	1.36E+01	8.44E+00
Total	3.97E+02	1.70E+02	5.85E+00	1.03E+02	6.25E+01

Table L.11 Absorbed Dose to Organs for an Adipose Male Healthcare Provider from Reference Male Patient for 37GBq/m² Surface Contamination (mGy/hr)

Organ	⁶⁰Co	¹⁹²Ir	²⁴¹Am	¹³⁷Cs	¹³¹I
Gonads	1.68E+01	6.12E+00	1.53E-01	4.13E+00	2.33E+00
Stomach	4.26E+01	1.81E+01	4.18E-01	1.10E+01	6.62E+00
Colon Wall	4.81E+01	1.79E+01	2.84E-01	1.16E+01	6.63E+00
Bladder	7.57E+01	2.83E+01	4.23E-01	1.84E+01	1.06E+01
Lungs	1.15E+01	4.59E+00	1.03E-01	2.91E+00	1.70E+00
Bone	1.47E+01	6.19E+00	2.28E-01	3.65E+00	2.22E+00
Liver	1.46E+01	6.07E+00	1.35E-01	3.73E+00	2.25E+00
Thyroid	1.61E+01	6.31E+00	1.40E-01	3.92E+00	2.30E+00
Esophagus	7.75E+00	2.64E+00	3.79E-02	1.79E+00	1.03E+00
Skin	1.13E+01	4.84E+00	5.51E-01	3.02E+00	1.80E+00
Other	1.02E+01	3.91E+00	7.40E-02	2.50E+00	1.41E+00
Breasts	2.94E+01	1.38E+01	1.04E+00	7.85E+00	4.73E+00
Total	2.99E+02	1.19E+02	3.59E+00	7.45E+01	4.36E+01

Table L.12 Absorbed Dose to Organs for an Adipose Male Healthcare Provider from Reference Female Patient for 37GBq/m² Surface Contamination (mGy/hr)

Organ	⁶⁰Co	¹⁹²Ir	²⁴¹Am	¹³⁷Cs	¹³¹I
Gonads	1.28E+01	4.18E+00	8.65E-02	2.86E+00	1.63E+00
Stomach	3.74E+01	1.57E+01	3.70E-01	9.53E+00	5.81E+00
Colon Wall	4.10E+01	1.44E+01	2.31E-01	9.50E+00	5.37E+00
Bladder	6.16E+01	2.08E+01	3.17E-01	1.42E+01	7.89E+00
Lungs	1.00E+01	3.96E+00	8.64E-02	2.50E+00	1.47E+00
Bone	1.27E+01	5.16E+00	1.89E-01	3.06E+00	1.85E+00
Liver	1.22E+01	4.87E+00	1.08E-01	3.01E+00	1.80E+00
Thyroid	1.33E+01	5.00E+00	1.15E-01	3.29E+00	1.88E+00
Esophagus	6.46E+00	2.27E+00	3.20E-02	1.55E+00	8.71E-01
Skin	9.52E+00	3.92E+00	4.24E-01	2.46E+00	1.46E+00
Other	8.84E+00	3.31E+00	5.80E-02	2.19E+00	1.22E+00
Breasts	2.51E+01	1.20E+01	7.87E-01	7.35E+00	4.21E+00
Total	2.51E+02	9.56E+01	2.80E+00	6.15E+01	3.55E+01

Table L.13 Absorbed Dose to Organs for an Adipose Male Healthcare Provider from Adipose Male Patient for 37GBq/m² Surface Contamination (mGy/hr)

Organ	⁶⁰Co	¹⁹²Ir	²⁴¹Am	¹³⁷Cs	¹³¹I
Gonads	1.72E+01	6.33E+00	1.39E-01	4.21E+00	2.37E+00
Stomach	4.74E+01	1.94E+01	4.38E-01	1.18E+01	7.10E+00
Colon Wall	5.21E+01	1.82E+01	2.81E-01	1.19E+01	6.86E+00
Bladder	8.22E+01	2.81E+01	4.08E-01	1.92E+01	1.06E+01
Lungs	1.30E+01	4.94E+00	1.06E-01	3.14E+00	1.82E+00
Bone	1.71E+01	6.82E+00	2.48E-01	4.08E+00	2.45E+00
Liver	1.49E+01	5.82E+00	1.25E-01	3.63E+00	2.16E+00
Thyroid	1.78E+01	6.69E+00	1.70E-01	4.20E+00	2.51E+00
Esophagus	9.03E+00	2.89E+00	3.98E-02	1.94E+00	1.11E+00
Skin	1.20E+01	4.69E+00	4.53E-01	3.01E+00	1.75E+00
Other	1.13E+01	3.98E+00	7.00E-02	2.64E+00	1.54E+00
Breasts	3.53E+01	1.43E+01	9.44E-01	9.00E+00	5.03E+00
Total	3.29E+02	1.22E+02	3.42E+00	7.88E+01	4.53E+01

Table L.14 Absorbed Dose to Organs for an Adipose Male Healthcare Provider from Adipose Female Patient for 37GBq/m² Surface Contamination (mGy/hr)

Organ	⁶⁰Co	¹⁹²Ir	²⁴¹Am	¹³⁷Cs	¹³¹I
Gonads	1.48E+01	5.07E+00	1.12E-01	3.36E+00	1.91E+00
Stomach	4.65E+01	1.93E+01	4.58E-01	1.17E+01	7.12E+00
Colon Wall	4.95E+01	1.77E+01	2.68E-01	1.15E+01	6.57E+00
Bladder	7.23E+01	2.51E+01	3.63E-01	1.65E+01	9.41E+00
Lungs	1.24E+01	4.86E+00	1.07E-01	3.07E+00	1.80E+00
Bone	1.54E+01	6.25E+00	2.33E-01	3.70E+00	2.23E+00
Liver	1.48E+01	5.95E+00	1.31E-01	3.66E+00	2.20E+00
Thyroid	1.68E+01	6.67E+00	1.55E-01	4.30E+00	2.35E+00
Esophagus	8.36E+00	2.90E+00	4.79E-02	1.91E+00	1.12E+00
Skin	1.14E+01	4.66E+00	4.96E-01	2.93E+00	1.74E+00
Other	1.09E+01	3.90E+00	6.50E-02	2.58E+00	1.42E+00
Breasts	3.21E+01	1.64E+01	1.01E+00	8.50E+00	5.52E+00
Total	3.05E+02	1.19E+02	3.45E+00	7.38E+01	4.34E+01

Table L.15 Absorbed Dose to Organs for an Adipose Male Healthcare Provider from Postmenopausal Adipose Female Patient for 37GBq/m² Surface Contamination (mGy/hr)

Organ	⁶⁰Co	¹⁹²Ir	²⁴¹Am	¹³⁷Cs	¹³¹I
Gonads	1.45E+01	5.09E+00	1.11E-01	3.47E+00	1.92E+00
Stomach	4.50E+01	1.84E+01	4.46E-01	1.13E+01	6.82E+00
Colon Wall	4.92E+01	1.69E+01	2.68E-01	1.12E+01	6.47E+00
Bladder	7.45E+01	2.51E+01	3.89E-01	1.70E+01	9.52E+00
Lungs	1.21E+01	4.68E+00	1.02E-01	2.95E+00	1.74E+00
Bone	1.54E+01	6.22E+00	2.29E-01	3.68E+00	2.22E+00
Liver	1.42E+01	5.66E+00	1.23E-01	3.50E+00	2.09E+00
Thyroid	1.68E+01	6.39E+00	1.55E-01	4.15E+00	2.54E+00
Esophagus	7.95E+00	2.71E+00	4.01E-02	1.86E+00	1.05E+00
Skin	1.12E+01	4.45E+00	4.50E-01	2.84E+00	1.67E+00
Other	1.06E+01	3.88E+00	6.48E-02	2.61E+00	1.51E+00
Breasts	3.02E+01	1.45E+01	9.51E-01	7.88E+00	5.00E+00
Total	3.02E+02	1.14E+02	3.33E+00	7.24E+01	4.25E+01

Table L.16 Absorbed Dose to Organs for an Adipose Female Healthcare Provider from Reference Male Patient for 37GBq/m² Surface Contamination (mGy/hr)

Organ	⁶⁰Co	¹⁹²Ir	²⁴¹Am	¹³⁷Cs	¹³¹I
Gonads	1.26E+01	4.77E+00	6.71E-02	2.97E+00	1.86E+00
Stomach	4.58E+01	1.98E+01	5.28E-01	1.18E+01	7.19E+00
Colon Wall	4.66E+01	1.74E+01	3.23E-01	1.11E+01	6.46E+00
Bladder	8.60E+01	3.22E+01	5.78E-01	2.06E+01	1.20E+01
Lungs	1.33E+01	5.28E+00	1.26E-01	3.31E+00	1.96E+00
Bone	1.67E+01	6.93E+00	2.86E-01	4.06E+00	2.47E+00
Liver	1.77E+01	7.49E+00	1.86E-01	4.54E+00	2.75E+00
Thyroid	1.50E+01	6.42E+00	1.78E-01	3.88E+00	2.38E+00
Esophagus	1.12E+01	3.74E+00	6.22E-02	2.60E+00	1.36E+00
Skin	1.91E+01	8.17E+00	8.66E-01	5.02E+00	3.03E+00
Other	1.35E+01	5.02E+00	9.75E-02	3.30E+00	1.88E+00
Breasts	6.19E+01	2.84E+01	1.58E+00	1.66E+01	1.04E+01
Total	3.59E+02	1.46E+02	4.88E+00	8.97E+01	5.38E+01

Table L.17 Absorbed Dose to Organs for an Adipose Female Healthcare Provider from Reference Female Patient for 37GBq/m² Surface Contamination (mGy/hr)

Organ	⁶⁰Co	¹⁹²Ir	²⁴¹Am	¹³⁷Cs	¹³¹I
Gonads	1.01E+01	3.66E+00	4.63E-02	2.34E+00	1.28E+00
Stomach	3.92E+01	1.71E+01	4.72E-01	1.01E+01	6.26E+00
Colon Wall	3.78E+01	1.41E+01	2.58E-01	9.04E+00	5.28E+00
Bladder	6.58E+01	2.39E+01	4.17E-01	1.54E+01	8.86E+00
Lungs	1.13E+01	4.54E+00	1.04E-01	2.81E+00	1.67E+00
Bone	1.40E+01	5.75E+00	2.34E-01	3.39E+00	2.06E+00
Liver	1.42E+01	5.96E+00	1.47E-01	3.59E+00	2.18E+00
Thyroid	1.40E+01	5.34E+00	1.68E-01	3.37E+00	2.01E+00
Esophagus	9.04E+00	3.43E+00	5.05E-02	2.23E+00	1.29E+00
Skin	1.57E+01	6.63E+00	6.69E-01	4.11E+00	2.46E+00
Other	1.10E+01	4.05E+00	7.81E-02	2.62E+00	1.56E+00
Breasts	5.26E+01	2.38E+01	1.30E+00	1.40E+01	8.76E+00
Total	2.95E+02	1.18E+02	3.95E+00	7.30E+01	4.37E+01

Table L.18 Absorbed Dose to Organs for an Adipose Female Healthcare Provider from Adipose Male Patient for 37GBq/m² Surface Contamination (mGy/hr)

Organ	⁶⁰Co	¹⁹²Ir	²⁴¹Am	¹³⁷Cs	¹³¹I
Gonads	1.47E+01	5.01E+00	6.35E-02	3.34E+00	1.89E+00
Stomach	4.76E+01	2.04E+01	5.24E-01	1.21E+01	7.36E+00
Colon Wall	4.84E+01	1.79E+01	3.18E-01	1.15E+01	6.61E+00
Bladder	9.07E+01	3.11E+01	5.23E-01	2.07E+01	1.17E+01
Lungs	1.44E+01	5.59E+00	1.27E-01	3.50E+00	2.07E+00
Bone	1.86E+01	7.48E+00	3.01E-01	4.45E+00	2.69E+00
Liver	1.69E+01	6.85E+00	1.62E-01	4.23E+00	2.54E+00
Thyroid	1.82E+01	6.88E+00	1.97E-01	4.55E+00	2.70E+00
Esophagus	1.23E+01	4.09E+00	5.88E-02	2.73E+00	1.49E+00
Skin	1.99E+01	8.00E+00	7.35E-01	5.03E+00	2.98E+00
Other	1.35E+01	5.05E+00	9.65E-02	3.35E+00	1.89E+00
Breasts	6.52E+01	2.84E+01	1.46E+00	1.70E+01	1.04E+01
Total	3.80E+02	1.47E+02	4.57E+00	9.25E+01	5.44E+01

Table L.19 Absorbed Dose to Organs for an Adipose Female Healthcare Provider from Adipose Female Patient for 37GBq/m² Surface Contamination (mGy/hr)

Organ	⁶⁰Co	¹⁹²Ir	²⁴¹Am	¹³⁷Cs	¹³¹I
Gonads	1.38E+01	4.47E+00	8.09E-02	3.18E+00	1.79E+00
Stomach	4.73E+01	2.09E+01	5.73E-01	1.23E+01	7.59E+00
Colon Wall	4.58E+01	1.71E+01	3.07E-01	1.09E+01	6.43E+00
Bladder	7.60E+01	2.78E+01	4.95E-01	1.80E+01	1.04E+01
Lungs	1.38E+01	5.53E+00	1.31E-01	3.39E+00	2.02E+00
Bone	1.69E+01	6.93E+00	2.87E-01	4.09E+00	2.48E+00
Liver	1.71E+01	7.18E+00	1.77E-01	4.35E+00	2.65E+00
Thyroid	1.63E+01	6.96E+00	2.05E-01	4.50E+00	2.56E+00
Esophagus	1.16E+01	3.99E+00	6.65E-02	2.66E+00	1.56E+00
Skin	1.91E+01	7.98E+00	7.93E-01	4.93E+00	2.96E+00
Other	1.38E+01	4.77E+00	9.97E-02	3.12E+00	1.85E+00
Breasts	6.40E+01	2.89E+01	1.55E+00	1.69E+01	1.06E+01
Total	3.55E+02	1.42E+02	4.77E+00	8.83E+01	5.29E+01

Table L.20 Absorbed Dose to Organs for an Adipose Female Healthcare Provider from Postmenopausal Adipose Female Patient for 37GBq/m² Surface Contamination (mGy/hr)

Organ	⁶⁰Co	¹⁹²Ir	²⁴¹Am	¹³⁷Cs	¹³¹I
Gonads	1.30E+01	4.32E+00	6.05E-02	2.92E+00	1.60E+00
Stomach	4.47E+01	1.96E+01	5.24E-01	1.16E+01	7.16E+00
Colon Wall	4.48E+01	1.66E+01	3.01E-01	1.08E+01	6.25E+00
Bladder	8.08E+01	2.85E+01	4.85E-01	1.88E+01	1.09E+01
Lungs	1.34E+01	5.24E+00	1.18E-01	3.30E+00	1.94E+00
Bone	1.69E+01	6.85E+00	2.80E-01	4.07E+00	2.46E+00
Liver	1.64E+01	6.77E+00	1.66E-01	4.12E+00	2.49E+00
Thyroid	1.59E+01	6.49E+00	2.10E-01	4.03E+00	2.55E+00
Esophagus	1.14E+01	3.89E+00	6.04E-02	2.59E+00	1.56E+00
Skin	1.85E+01	7.61E+00	7.30E-01	4.75E+00	2.83E+00
Other	1.26E+01	4.85E+00	9.27E-02	3.20E+00	1.79E+00
Breasts	6.10E+01	2.71E+01	1.44E+00	1.60E+01	9.97E+00
Total	3.50E+02	1.38E+02	4.46E+00	8.61E+01	5.15E+01

Table L.21 Absorbed Dose to Organs for a Postmenopausal Adipose Female Healthcare Provider from Reference Male Patient for 37GBq/m² Surface Contamination (mGy/hr)

Organ	⁶⁰Co	¹⁹²Ir	²⁴¹Am	¹³⁷Cs	¹³¹I
Gonads	2.50E+01	9.16E+00	1.35E-01	6.05E+00	3.32E+00
Stomach	4.23E+01	1.79E+01	4.47E-01	1.07E+01	6.60E+00
Colon Wall	4.27E+01	1.60E+01	2.61E-01	1.01E+01	5.90E+00
Bladder	8.08E+01	2.87E+01	4.82E-01	1.88E+01	1.08E+01
Lungs	1.29E+01	5.10E+00	1.14E-01	3.17E+00	1.88E+00
Bone	1.62E+01	6.72E+00	2.51E-01	3.92E+00	2.40E+00
Liver	1.66E+01	6.87E+00	1.58E-01	4.17E+00	2.53E+00
Thyroid	2.13E+01	8.47E+00	2.12E-01	5.42E+00	3.23E+00
Esophagus	9.82E+00	3.54E+00	5.47E-02	2.37E+00	1.33E+00
Skin	1.75E+01	7.44E+00	7.98E-01	4.58E+00	2.75E+00
Other	1.27E+01	4.68E+00	8.41E-02	2.96E+00	1.70E+00
Breasts	5.78E+01	2.65E+01	1.50E+00	1.54E+01	9.72E+00
Total	3.56E+02	1.41E+02	4.50E+00	8.78E+01	5.22E+01

Table L.22 Absorbed Dose to Organs for a Postmenopausal Adipose Female Healthcare Provider from Reference Female Patient for 37GBq/m² Surface Contamination (mGy/hr)

Organ	⁶⁰Co	¹⁹²Ir	²⁴¹Am	¹³⁷Cs	¹³¹I
Gonads	2.11E+01	6.68E+00	9.99E-02	4.64E+00	2.89E+00
Stomach	3.63E+01	1.56E+01	3.77E-01	9.29E+00	5.72E+00
Colon Wall	3.56E+01	1.27E+01	2.05E-01	8.28E+00	4.75E+00
Bladder	6.14E+01	2.11E+01	3.30E-01	1.42E+01	7.91E+00
Lungs	1.10E+01	4.31E+00	9.38E-02	2.72E+00	1.59E+00
Bone	1.35E+01	5.56E+00	2.07E-01	3.27E+00	1.99E+00
Liver	1.33E+01	5.53E+00	1.25E-01	3.37E+00	2.03E+00
Thyroid	1.98E+01	7.33E+00	2.05E-01	4.77E+00	2.76E+00
Esophagus	8.97E+00	3.41E+00	4.63E-02	2.18E+00	1.23E+00
Skin	1.44E+01	6.02E+00	6.17E-01	3.74E+00	2.24E+00
Other	1.13E+01	3.96E+00	7.37E-02	2.59E+00	1.49E+00
Breasts	4.90E+01	2.22E+01	1.23E+00	1.30E+01	8.16E+00
Total	2.96E+02	1.14E+02	3.61E+00	7.21E+01	4.28E+01

Table L.23 Absorbed Dose to Organs for a Postmenopausal Adipose Female Healthcare Provider from Adipose Male Patient for 37GBq/m² Surface Contamination (mGy/hr)

Organ	⁶⁰Co	¹⁹²Ir	²⁴¹Am	¹³⁷Cs	¹³¹I
Gonads	2.76E+01	9.50E+00	1.29E-01	6.03E+00	3.26E+00
Stomach	4.46E+01	1.87E+01	4.47E-01	1.13E+01	6.94E+00
Colon Wall	4.53E+01	1.62E+01	2.67E-01	1.07E+01	6.04E+00
Bladder	8.25E+01	2.81E+01	4.33E-01	1.91E+01	1.06E+01
Lungs	1.39E+01	5.34E+00	1.13E-01	3.36E+00	1.97E+00
Bone	1.81E+01	7.29E+00	2.68E-01	4.31E+00	2.62E+00
Liver	1.61E+01	6.36E+00	1.41E-01	3.96E+00	2.36E+00
Thyroid	2.66E+01	9.87E+00	2.61E-01	6.20E+00	3.77E+00
Esophagus	1.15E+01	3.99E+00	4.99E-02	2.74E+00	1.46E+00
Skin	1.81E+01	7.21E+00	6.69E-01	4.55E+00	2.69E+00
Other	1.29E+01	4.83E+00	8.28E-02	3.07E+00	1.78E+00
Breasts	6.06E+01	2.64E+01	1.39E+00	1.58E+01	9.69E+00
Total	3.78E+02	1.44E+02	4.25E+00	9.11E+01	5.32E+01

Table L.24 Absorbed Dose to Organs for a Postmenopausal Adipose Female Healthcare Provider from Adipose Female Patient for 37GBq/m² Surface Contamination (mGy/hr)

Organ	⁶⁰Co	¹⁹²Ir	²⁴¹Am	¹³⁷Cs	¹³¹I
Gonads	2.53E+01	8.80E+00	1.18E-01	5.55E+00	3.26E+00
Stomach	4.47E+01	1.93E+01	4.96E-01	1.15E+01	7.03E+00
Colon Wall	4.28E+01	1.57E+01	2.61E-01	1.02E+01	5.92E+00
Bladder	7.21E+01	2.50E+01	3.99E-01	1.67E+01	9.36E+00
Lungs	1.33E+01	5.24E+00	1.15E-01	3.26E+00	1.91E+00
Bone	1.63E+01	6.73E+00	2.54E-01	3.95E+00	2.41E+00
Liver	1.62E+01	6.65E+00	1.50E-01	4.04E+00	2.46E+00
Thyroid	2.47E+01	9.48E+00	2.62E-01	6.05E+00	3.50E+00
Esophagus	1.03E+01	3.64E+00	6.12E-02	2.53E+00	1.42E+00
Skin	1.73E+01	7.24E+00	7.28E-01	4.48E+00	2.69E+00
Other	1.26E+01	4.70E+00	7.91E-02	2.95E+00	1.72E+00
Breasts	5.95E+01	2.68E+01	1.47E+00	1.58E+01	9.86E+00
Total	3.55E+02	1.39E+02	4.39E+00	8.68E+01	5.15E+01

Table L.25 Absorbed Dose to Organs for a Postmenopausal Adipose Female Healthcare Provider from Postmenopausal Adipose Female Patient for 37GBq/m² Surface Contamination (mGy/hr)

Organ	⁶⁰Co	¹⁹²Ir	²⁴¹Am	¹³⁷Cs	¹³¹I
Gonads	2.69E+01	7.44E+00	1.43E-01	5.72E+00	3.10E+00
Stomach	4.24E+01	1.81E+01	4.56E-01	1.08E+01	6.62E+00
Colon Wall	4.32E+01	1.52E+01	2.44E-01	9.92E+00	5.67E+00
Bladder	7.37E+01	2.46E+01	3.94E-01	1.70E+01	9.61E+00
Lungs	1.29E+01	5.03E+00	1.08E-01	3.14E+00	1.84E+00
Bone	1.63E+01	6.68E+00	2.49E-01	3.93E+00	2.38E+00
Liver	1.54E+01	6.22E+00	1.41E-01	3.84E+00	2.31E+00
Thyroid	2.28E+01	9.16E+00	2.44E-01	5.84E+00	3.45E+00
Esophagus	1.11E+01	3.61E+00	5.72E-02	2.59E+00	1.42E+00
Skin	1.68E+01	6.96E+00	6.66E-01	4.32E+00	2.57E+00
Other	1.30E+01	4.61E+00	8.83E-02	3.09E+00	1.79E+00
Breasts	5.66E+01	2.54E+01	1.36E+00	1.50E+01	9.28E+00
Total	3.51E+02	1.33E+02	4.15E+00	8.51E+01	5.00E+01

APPENDIX M

ABSORBED DOSE TO ORGANS FOR HEALTHCARE PROVIDER DUE TO INTERNALLY CONTAMINATED PATIENT

Table M.1 Absorbed Dose to Organs for a Reference Male Healthcare Provider from Reference Male Patient for Internal Contamination ($\mu\text{Gy/hr}$) /ALI

Organ	^{60}Co (s)	^{60}Co (m)	^{192}Ir (s)	^{192}Ir (m)	^{192}Ir (f)	^{241}Am	^{137}Cs	^{131}I
Gonads	0.151	0.920	0.414	0.491	1.250	5.78E-07	0.389	0.132
Stomach	1.198	3.604	2.489	2.878	7.452	6.58E-06	1.827	0.718
Colon Wall	1.526	4.712	2.974	3.465	8.498	6.53E-06	2.320	0.868
Bladder	2.599	7.985	5.126	5.936	14.390	1.17E-05	3.914	1.416
Lungs	0.328	1.003	0.636	0.775	1.805	1.86E-06	0.483	0.193
Bone	0.380	1.175	0.758	0.913	2.231	3.26E-06	0.568	0.224
Liver	0.426	1.330	0.861	1.044	2.155	2.50E-06	0.628	0.252
Thyroid	0.470	1.409	0.962	1.175	2.904	3.42E-06	0.691	0.276
Esophagus	0.214	0.667	0.363	0.437	0.993	5.95E-07	0.290	0.108
Skin	0.237	0.731	0.433	0.517	1.250	1.25E-06	0.357	0.133
Other	0.338	1.051	0.623	0.765	1.698	1.36E-06	0.499	0.186
Total	7.868	24.587	15.638	18.396	44.624	3.96E-05	11.966	4.507

Table M.2 Absorbed Dose to Organs for a Reference Male Healthcare Provider from Reference Female Patient for Internal Contamination ($\mu\text{Gy/hr}$) /ALI

Organ	^{60}Co (s)	^{60}Co (m)	^{192}Ir (s)	^{192}Ir (m)	^{192}Ir (f)	^{241}Am	^{137}Cs	^{131}I
Gonads	0.319	0.986	0.428	0.542	1.279	7.86E-07	0.484	0.125
Stomach	1.284	3.884	2.486	3.144	8.068	7.58E-06	1.904	0.736
Colon Wall	1.633	5.076	3.067	3.858	9.108	7.81E-06	2.828	0.884
Bladder	2.780	8.592	5.236	6.573	15.489	1.40E-05	4.871	1.468
Lungs	0.338	1.034	0.640	0.805	1.909	2.00E-06	0.550	0.203
Bone	0.394	1.219	0.759	0.959	2.353	3.47E-06	0.649	0.230
Liver	0.441	1.380	0.883	1.104	2.283	2.74E-06	0.855	0.268
Thyroid	0.477	1.450	0.945	1.188	3.047	3.49E-06	0.798	0.301
Esophagus	0.214	0.653	0.358	0.441	1.116	7.47E-07	0.339	0.116
Skin	0.248	0.767	0.436	0.551	1.322	1.39E-06	0.413	0.137
Other	0.352	1.053	0.608	0.779	1.867	1.58E-06	0.529	0.195
Total	8.478	26.093	15.847	19.943	47.839	4.56E-05	14.219	4.662

Table M.3 Absorbed Dose to Organs for a Reference Male Healthcare Provider from Adipose Male Patient for Internal Contamination ($\mu\text{Gy/hr}$) /ALI

Organ	^{60}Co (s)	^{60}Co (m)	^{192}Ir (s)	^{192}Ir (m)	^{192}Ir (f)	^{241}Am	^{137}Cs	^{131}I
Gonads	0.338	1.035	0.494	0.635	1.704	9.11E-07	0.483	0.151
Stomach	1.112	3.364	2.043	2.595	7.673	4.92E-06	1.887	0.632
Colon Wall	1.457	4.515	2.603	3.312	9.017	5.31E-06	2.407	0.798
Bladder	2.481	7.776	4.684	5.917	16.089	1.08E-05	4.134	1.363
Lungs	0.285	0.887	0.508	0.647	1.772	1.28E-06	0.477	0.172
Bone	0.348	1.087	0.650	0.825	2.248	2.36E-06	0.569	0.207
Liver	0.395	1.246	0.749	0.942	2.243	1.93E-06	0.638	0.234
Thyroid	0.374	1.191	0.694	0.845	2.724	1.95E-06	0.680	0.251
Esophagus	0.178	0.550	0.270	0.343	0.989	3.96E-07	0.279	0.096
Skin	0.216	0.674	0.364	0.460	1.265	9.70E-07	0.359	0.122
Other	0.299	0.909	0.522	0.666	1.673	1.02E-06	0.485	0.164
Total	7.484	23.235	13.583	17.187	47.397	3.19E-05	12.397	4.188

Table M.4 Absorbed Dose to Organs for a Reference Male Healthcare Provider from Adipose Female Patient for Internal Contamination ($\mu\text{Gy/hr}$) /ALI

Organ	^{60}Co (s)	^{60}Co (m)	^{192}Ir (s)	^{192}Ir (m)	^{192}Ir (f)	^{241}Am	^{137}Cs	^{131}I
Gonads	0.333	1.046	0.463	0.589	1.408	7.93E-07	0.429	0.139
Stomach	1.221	3.689	2.337	2.974	8.376	6.55E-06	2.034	0.718
Colon Wall	1.577	4.898	2.913	3.666	9.438	6.97E-06	2.503	0.873
Bladder	2.715	8.448	5.048	6.355	15.799	1.27E-05	4.223	1.438
Lungs	0.307	0.950	0.562	0.716	1.898	1.54E-06	0.494	0.186
Bone	0.368	1.148	0.699	0.884	2.331	2.74E-06	0.584	0.219
Liver	0.421	1.322	0.826	1.039	2.344	2.33E-06	0.661	0.254
Thyroid	0.419	1.344	0.776	0.995	2.906	2.37E-06	0.715	0.291
Esophagus	0.194	0.605	0.317	0.398	1.078	5.56E-07	0.297	0.110
Skin	0.231	0.722	0.398	0.504	1.325	1.16E-06	0.369	0.130
Other	0.311	0.955	0.538	0.700	2.060	1.21E-06	0.526	0.188
Total	8.097	25.126	14.877	18.820	48.961	3.89E-05	12.835	4.546

Table M.5 Absorbed Dose to Organs for a Reference Male Healthcare Provider from Postmenopausal Adipose Female Patient for Internal Contamination ($\mu\text{Gy/hr}$) /ALI

Organ	^{60}Co (s)	^{60}Co (m)	^{192}Ir (s)	^{192}Ir (m)	^{192}Ir (f)	^{241}Am	^{137}Cs	^{131}I
Gonads	0.346	1.058	0.498	0.631	2.206	8.89E-07	0.778	0.140
Stomach	1.177	3.571	2.206	2.810	8.718	5.65E-06	2.920	0.678
Colon Wall	1.520	4.729	2.779	3.507	12.047	6.08E-06	3.755	0.830
Bladder	2.609	8.149	4.932	6.206	21.253	1.23E-05	6.238	1.417
Lungs	0.299	0.923	0.537	0.679	2.144	1.38E-06	0.731	0.177
Bone	0.359	1.115	0.672	0.851	2.762	2.47E-06	0.892	0.211
Liver	0.405	1.271	0.783	0.982	3.383	2.08E-06	0.961	0.239
Thyroid	0.391	1.225	0.737	0.930	2.932	2.03E-06	1.026	0.264
Esophagus	0.191	0.576	0.298	0.373	1.146	4.82E-07	0.446	0.102
Skin	0.222	0.692	0.378	0.479	1.600	1.03E-06	0.556	0.125
Other	0.303	0.930	0.508	0.658	2.167	1.10E-06	0.775	0.172
Total	7.823	24.238	14.327	18.107	60.356	3.55E-05	19.077	4.354

Table M.6 Absorbed Dose to Organs for a Reference Female Healthcare Provider from Reference Male Patient for Internal Contamination ($\mu\text{Gy/hr}$) /ALI

Organ	^{60}Co (s)	^{60}Co (m)	^{192}Ir (s)	^{192}Ir (m)	^{192}Ir (f)	^{241}Am	^{137}Cs	^{131}I
Gonads	0.378	1.150	0.715	0.832	2.127	1.16E-06	0.568	1.991
Stomach	1.117	3.355	2.298	2.637	6.853	6.17E-06	1.708	6.631
Colon Wall	1.289	4.027	2.500	2.925	7.311	5.61E-06	2.001	7.431
Bladder	2.572	7.921	4.983	5.778	14.065	1.11E-05	3.803	13.815
Lungs	0.336	1.029	0.634	0.765	1.791	1.70E-06	0.498	1.948
Bone	0.404	1.246	0.799	0.961	2.353	3.36E-06	0.600	2.361
Liver	0.448	1.400	0.909	1.097	2.304	2.60E-06	0.665	2.662
Thyroid	0.418	1.267	0.850	1.084	2.625	3.22E-06	0.627	2.710
Esophagus	0.268	0.824	0.450	0.545	1.338	8.06E-07	0.371	1.378
Skin	0.359	1.105	0.646	0.774	1.871	1.79E-06	0.534	1.989
Other	0.360	1.069	0.624	0.756	1.925	1.47E-06	0.513	2.017
Breast	1.324	4.045	2.775	3.366	7.594	1.01E-05	1.967	8.126
Total	9.273	28.437	18.184	21.520	52.157	4.92E-05	13.853	53.059

Table M.7 Absorbed Dose to Organs for a Reference Female Healthcare Provider from Reference Female Patient for Internal Contamination ($\mu\text{Gy/hr}$) /ALI

Organ	^{60}Co (s)	^{60}Co (m)	^{192}Ir (s)	^{192}Ir (m)	^{192}Ir (f)	^{241}Am	^{137}Cs	^{131}I
Gonads	0.403	1.211	0.702	0.880	2.208	1.63E-06	0.711	0.217
Stomach	1.178	3.574	2.324	2.938	7.439	7.19E-06	1.789	0.683
Colon Wall	1.397	4.337	2.622	3.294	7.764	6.68E-06	2.410	0.749
Bladder	2.717	8.442	5.098	6.412	14.932	1.34E-05	4.811	1.419
Lungs	0.345	1.061	0.635	0.802	1.875	1.80E-06	0.571	0.206
Bone	0.417	1.292	0.801	1.011	2.475	3.63E-06	0.687	0.242
Liver	0.464	1.457	0.937	1.173	2.437	2.86E-06	0.913	0.282
Thyroid	0.422	1.285	0.872	1.104	2.625	3.23E-06	0.692	0.287
Esophagus	0.282	0.881	0.452	0.566	1.387	9.07E-07	0.397	0.149
Skin	0.374	1.158	0.649	0.818	1.979	1.96E-06	0.617	0.204
Other	0.366	1.088	0.639	0.822	1.911	1.52E-06	0.587	0.205
Breast	1.354	4.129	2.764	3.479	8.067	1.08E-05	2.294	1.484
Total	9.719	29.914	18.494	23.301	55.098	5.56E-05	16.479	6.127

Table M.8 Absorbed Dose to Organs for a Reference Female Healthcare Provider from Adipose Male Patient for Internal Contamination ($\mu\text{Gy/hr}$) /ALI

Organ	^{60}Co (s)	^{60}Co (m)	^{192}Ir (s)	^{192}Ir (m)	^{192}Ir (f)	^{241}Am	^{137}Cs	^{131}I
Gonads	0.349	1.099	0.597	0.766	2.082	1.05E-06	0.569	0.201
Stomach	1.037	3.129	1.891	2.412	7.216	4.79E-06	1.755	0.589
Colon Wall	1.231	3.862	2.210	2.801	7.744	4.53E-06	2.043	0.680
Bladder	2.473	7.741	4.596	5.788	15.735	1.05E-05	4.065	1.350
Lungs	0.297	0.923	0.514	0.652	1.771	1.20E-06	0.491	0.174
Bone	0.370	1.156	0.691	0.875	2.388	2.50E-06	0.606	0.219
Liver	0.418	1.315	0.792	0.998	2.416	2.06E-06	0.682	0.245
Thyroid	0.347	1.081	0.661	0.828	2.387	1.83E-06	0.657	0.248
Esophagus	0.231	0.716	0.355	0.457	1.292	5.78E-07	0.352	0.119
Skin	0.326	1.016	0.542	0.687	1.881	1.38E-06	0.538	0.181
Other	0.328	0.994	2.230	0.686	1.904	1.25E-06	0.495	0.179
Breast	1.156	3.586	24.542	2.824	7.598	7.12E-06	1.981	0.716
Total	8.563	26.619	39.620	19.774	54.413	3.87E-05	14.235	4.904

Table M.9 Absorbed Dose to Organs for a Reference Female Healthcare Provider from Adipose Female Patient for Internal Contamination ($\mu\text{Gy/hr}$) /ALI

Organ	^{60}Co (s)	^{60}Co (m)	^{192}Ir (s)	^{192}Ir (m)	^{192}Ir (f)	^{241}Am	^{137}Cs	^{131}I
Gonads	0.38	1.18	0.68	0.84	2.90	1.17E-06	0.64	0.24
Stomach	1.14	3.43	2.19	2.79	8.53	6.14E-06	1.89	0.75
Colon Wall	1.33	4.11	2.46	3.09	10.43	5.90E-06	2.15	0.84
Bladder	2.66	8.29	4.92	6.21	20.67	1.20E-05	4.14	1.58
Lungs	0.32	1.00	0.57	0.73	2.29	1.47E-06	0.51	0.21
Bone	0.39	1.22	0.74	0.94	2.99	2.90E-06	0.62	0.26
Liver	0.45	1.40	0.88	1.11	3.72	2.47E-06	0.71	0.30
Thyroid	0.37	1.17	0.72	0.90	2.84	2.11E-06	0.65	0.30
Esophagus	0.25	0.80	0.39	0.49	1.60	7.18E-07	0.38	0.15
Skin	0.35	1.09	0.60	0.75	2.44	1.64E-06	0.55	0.22
Other	0.35	1.09	0.58	0.74	2.48	1.24E-06	0.54	0.23
Breast	1.24	3.81	2.47	3.13	9.94	8.48E-06	2.06	0.87
Total	9.22	28.60	17.21	21.74	70.83	4.62E-05	14.84	5.94

Table M.10 Absorbed Dose to Organs for a Reference Female Healthcare Provider from Postmenopausal Adipose Female Patient for Internal Contamination ($\mu\text{Gy/hr}$) /ALI

Organ	^{60}Co (s)	^{60}Co (m)	^{192}Ir (s)	^{192}Ir (m)	^{192}Ir (f)	^{241}Am	^{137}Cs	^{131}I
Gonads	0.365	1.141	0.659	0.836	2.037	1.27E-06	0.921	0.194
Stomach	1.085	3.302	2.082	2.654	7.336	5.28E-06	2.706	0.632
Colon Wall	1.303	4.051	2.382	3.003	7.818	5.27E-06	3.200	0.712
Bladder	2.593	8.075	4.818	6.072	15.541	1.19E-05	6.200	1.383
Lungs	0.310	0.959	0.538	0.684	1.788	1.30E-06	0.771	0.180
Bone	0.381	1.190	0.715	0.905	2.378	2.63E-06	0.948	0.223
Liver	0.429	1.347	0.834	1.047	2.381	2.21E-06	1.025	0.253
Thyroid	0.344	1.072	0.668	0.864	2.415	2.00E-06	0.927	0.240
Esophagus	0.249	0.802	0.369	0.465	1.337	6.41E-07	0.559	0.122
Skin	0.338	1.050	0.565	0.715	1.898	1.47E-06	0.840	0.185
Other	0.327	1.006	0.557	0.707	1.898	1.09E-06	0.820	0.183
Breast	1.210	3.731	2.361	2.993	7.658	7.74E-06	2.959	0.738
Total	8.933	27.727	16.547	20.946	54.485	4.28E-05	21.875	5.046

Table M.11 Absorbed Dose to Organs for an Adipose Male Healthcare Provider from Reference Male Patient for Internal Contamination ($\mu\text{Gy/hr}$) /ALI

Organ	^{60}Co (s)	^{60}Co (m)	^{192}Ir (s)	^{192}Ir (m)	^{192}Ir (f)	^{241}Am	^{137}Cs	^{131}I
Gonads	0.486	1.502	0.830	0.990	2.347	1.83E-06	0.654	0.247
Stomach	0.930	2.765	1.661	1.895	5.145	3.28E-06	1.331	0.503
Colon Wall	0.959	2.981	1.512	1.760	4.550	1.91E-06	1.365	0.484
Bladder	1.588	4.940	2.612	3.042	7.706	3.51E-06	2.234	0.774
Lungs	0.291	0.888	0.525	0.640	1.487	1.28E-06	0.412	0.162
Bone	0.354	1.098	0.690	0.829	2.019	2.50E-06	0.524	0.207
Liver	0.366	1.156	0.673	0.824	1.594	1.64E-06	0.517	0.202
Thyroid	0.404	1.213	0.733	0.926	2.133	2.11E-06	0.592	0.226
Esophagus	0.186	0.585	0.292	0.350	0.824	5.25E-07	0.244	0.091
Skin	0.273	0.842	0.498	0.595	1.449	1.41E-06	0.408	0.150
Other	0.238	0.736	0.444	0.518	1.090	6.93E-07	0.334	0.126
Breast	0.812	2.434	1.574	2.098	4.521	6.16E-06	1.153	0.489
Total	6.886	21.139	12.043	14.465	34.867	2.68E-05	9.770	3.660

Table M.12 Absorbed Dose to Organs for an Adipose Male Healthcare Provider from Reference Female Patient for Internal Contamination ($\mu\text{Gy/hr}$) /ALI

Organ	^{60}Co (s)	^{60}Co (m)	^{192}Ir (s)	^{192}Ir (m)	^{192}Ir (f)	^{241}Am	^{137}Cs	^{131}I
Gonads	0.454	1.397	0.714	0.934	1.965	1.50E-06	0.762	0.204
Stomach	0.977	2.930	1.603	1.727	5.629	3.80E-06	1.198	0.505
Colon Wall	1.020	3.186	1.493	1.615	4.650	2.10E-06	1.578	0.477
Bladder	1.694	5.320	2.548	2.736	7.753	3.62E-06	2.708	0.746
Lungs	0.302	0.923	0.526	0.533	1.576	1.37E-06	0.474	0.170
Bone	0.357	1.108	0.659	0.723	2.040	2.51E-06	0.585	0.205
Liver	0.375	1.185	0.690	0.741	1.687	1.76E-06	0.742	0.218
Thyroid	0.405	1.254	0.746	0.721	2.390	2.50E-06	0.651	0.252
Esophagus	0.194	0.580	0.289	0.283	0.908	5.16E-07	0.279	0.099
Skin	0.282	0.871	0.492	0.521	1.485	1.49E-06	0.469	0.150
Other	0.239	0.726	0.360	0.469	1.209	7.75E-07	0.347	0.127
Breast	0.728	2.127	1.650	2.054	4.766	7.19E-06	1.244	0.490
Total	7.028	21.608	11.770	13.057	36.056	2.91E-05	11.037	3.643

Table M.13 Absorbed Dose to Organs for an Adipose Male Healthcare Provider from Adipose Male Patient for Internal Contamination ($\mu\text{Gy/hr}$) /ALI

Organ	^{60}Co (s)	^{60}Co (m)	^{192}Ir (s)	^{192}Ir (m)	^{192}Ir (f)	^{241}Am	^{137}Cs	^{131}I
Gonads	0.457	1.400	0.740	0.934	2.146	1.41E-06	0.622	0.197
Stomach	0.854	2.561	1.348	1.727	5.363	2.45E-06	1.385	0.451
Colon Wall	0.876	2.773	1.275	1.615	4.569	1.55E-06	1.380	0.432
Bladder	1.470	4.612	2.174	2.736	7.479	2.68E-06	2.188	0.664
Lungs	0.254	0.789	0.420	0.533	1.449	8.55E-07	0.411	0.144
Bone	0.318	0.996	0.571	0.723	1.943	1.74E-06	0.508	0.185
Liver	0.338	1.073	0.588	0.741	1.702	1.25E-06	0.526	0.190
Thyroid	0.334	1.040	0.556	0.721	2.079	1.33E-06	0.589	0.210
Esophagus	0.161	0.494	0.219	0.283	0.857	2.45E-07	0.239	0.081
Skin	0.248	0.773	0.411	0.521	1.422	1.06E-06	0.401	0.133
Other	0.202	0.629	0.319	0.404	1.078	4.57E-07	0.323	0.107
Breast	0.704	2.059	1.308	1.595	4.554	4.43E-06	1.229	0.394
Total	6.216	19.200	9.929	12.532	34.641	1.94E-05	9.803	3.188

Table M.14 Absorbed Dose to Organs for an Adipose Male Healthcare Provider from Adipose Female Patient for Internal Contamination ($\mu\text{Gy/hr}$) /ALI

Organ	^{60}Co (s)	^{60}Co (m)	^{192}Ir (s)	^{192}Ir (m)	^{192}Ir (f)	^{241}Am	^{137}Cs	^{131}I
Gonads	0.440	1.352	0.698	0.870	1.823	1.45E-06	0.588	0.221
Stomach	0.939	2.817	1.509	1.938	5.884	3.24E-06	1.494	0.563
Colon Wall	0.964	3.033	1.408	1.770	4.773	1.91E-06	1.448	0.515
Bladder	1.616	5.091	2.385	3.027	7.743	3.12E-06	2.308	0.803
Lungs	0.272	0.841	0.461	0.588	1.570	1.02E-06	0.425	0.176
Bone	0.334	1.044	0.606	0.767	2.021	1.98E-06	0.521	0.217
Liver	0.360	1.142	0.643	0.809	1.745	1.50E-06	0.541	0.231
Thyroid	0.358	1.146	0.620	0.792	2.238	1.58E-06	0.569	0.255
Esophagus	0.179	0.549	0.261	0.325	0.916	3.92E-07	0.254	0.103
Skin	0.265	0.826	0.453	0.572	1.487	1.25E-06	0.418	0.160
Other	0.224	0.689	0.341	0.446	1.271	5.54E-07	0.351	0.140
Breast	0.613	2.055	1.492	1.988	4.659	5.78E-06	1.285	0.498
Total	6.565	20.585	10.877	13.893	36.129	2.38E-05	10.201	3.884

Table M.15 Absorbed Dose to Organs for an Adipose Male Healthcare Provider from Postmenopausal Adipose Female Patient for Internal Contamination ($\mu\text{Gy/hr}$) /ALI

Organ	^{60}Co (s)	^{60}Co (m)	^{192}Ir (s)	^{192}Ir (m)	^{192}Ir (f)	^{241}Am	^{137}Cs	^{131}I
Gonads	0.468	1.424	0.739	0.919	2.863	1.41E-06	0.982	0.204
Stomach	0.890	2.688	1.426	1.828	5.344	2.83E-06	2.257	0.474
Colon Wall	0.926	2.896	1.329	1.681	5.833	1.59E-06	2.329	0.442
Bladder	1.539	4.810	2.264	2.846	9.928	2.97E-06	3.669	0.684
Lungs	0.265	0.823	0.438	0.555	1.756	9.40E-07	0.648	0.148
Bone	0.326	1.016	0.586	0.741	2.384	1.79E-06	0.807	0.187
Liver	0.345	1.091	0.609	0.763	2.637	1.29E-06	0.812	0.192
Thyroid	0.332	1.026	0.568	0.719	2.377	1.50E-06	0.858	0.208
Esophagus	0.163	0.497	0.244	0.306	0.965	2.85E-07	0.391	0.086
Skin	0.256	0.797	0.431	0.545	1.837	1.14E-06	0.630	0.137
Other	0.202	0.635	0.315	0.400	1.310	4.88E-07	0.528	0.113
Breast	0.603	1.915	1.400	1.777	5.641	4.81E-06	1.710	0.424
Total	6.316	19.616	10.349	13.080	42.878	2.11E-05	15.622	3.299

Table M.16 Absorbed Dose to Organs for an Adipose Female Healthcare Provider from Reference Male Patient for Internal Contamination ($\mu\text{Gy/hr}$) /ALI

Organ	^{60}Co (s)	^{60}Co (m)	^{192}Ir (s)	^{192}Ir (m)	^{192}Ir (f)	^{241}Am	^{137}Cs	^{131}I
Gonads	0.263	0.834	0.456	0.527	1.185	4.64E-07	0.350	0.122
Stomach	0.973	2.905	1.850	2.119	5.606	4.11E-06	1.464	0.547
Colon Wall	0.917	2.847	1.551	1.811	4.614	2.37E-06	1.385	0.476
Bladder	1.824	5.577	3.062	3.609	9.186	4.85E-06	2.630	0.929
Lungs	0.321	0.980	0.584	0.704	1.631	1.43E-06	0.466	0.180
Bone	0.388	1.200	0.762	0.916	2.219	2.94E-06	0.574	0.226
Liver	0.416	1.306	0.807	0.980	1.970	2.15E-06	0.601	0.238
Thyroid	0.403	1.230	0.810	0.989	2.416	2.69E-06	0.584	0.244
Esophagus	0.248	0.779	0.384	0.468	1.245	5.98E-07	0.335	0.121
Skin	0.445	1.373	0.824	0.984	2.383	2.40E-06	0.668	0.226
Other	0.294	0.874	0.497	0.604	1.400	8.81E-07	0.433	0.153
Breast	1.563	4.768	3.279	3.987	9.065	1.22E-05	2.336	0.962
Total	8.056	24.674	14.865	17.697	42.920	3.71E-05	11.826	4.425

Table M.17 Absorbed Dose to Organs for an Adipose Female Healthcare Provider from Reference Female Patient for Internal Contamination ($\mu\text{Gy/hr}$) /ALI

Organ	^{60}Co (s)	^{60}Co (m)	^{192}Ir (s)	^{192}Ir (m)	^{192}Ir (f)	^{241}Am	^{137}Cs	^{131}I
Gonads	0.268	0.860	0.393	0.508	1.267	7.20E-07	0.393	0.136
Stomach	1.041	3.105	1.865	2.355	6.147	4.79E-06	1.400	0.560
Colon Wall	0.978	3.064	1.518	1.919	4.736	2.66E-06	1.567	0.473
Bladder	1.893	5.919	3.044	3.827	9.128	4.90E-06	3.102	0.872
Lungs	0.333	1.022	0.588	0.744	1.751	1.53E-06	0.534	0.187
Bone	0.390	1.211	0.732	0.923	2.255	3.00E-06	0.641	0.224
Liver	0.435	1.370	0.833	1.040	2.087	2.31E-06	0.857	0.255
Thyroid	0.401	1.215	0.777	0.990	2.462	2.47E-06	0.650	0.255
Esophagus	0.255	0.809	0.421	0.527	1.284	7.41E-07	0.390	0.136
Skin	0.462	1.424	0.823	1.037	2.469	2.58E-06	0.769	0.227
Other	0.311	0.935	0.497	0.641	1.535	9.66E-07	0.465	0.165
Breast	1.609	4.910	3.294	4.144	9.651	1.30E-05	2.720	0.994
Total	8.376	25.844	14.785	18.655	44.770	3.97E-05	13.490	4.484

Table M.18 Absorbed Dose to Organs for an Adipose Female Healthcare Provider from Adipose Male Patient for Internal Contamination ($\mu\text{Gy/hr}$) /ALI

Organ	^{60}Co (s)	^{60}Co (m)	^{192}Ir (s)	^{192}Ir (m)	^{192}Ir (f)	^{241}Am	^{137}Cs	^{131}I
Gonads	0.245	0.766	0.352	0.448	1.236	3.87E-07	0.392	0.108
Stomach	0.910	2.743	1.520	1.950	5.938	3.28E-06	1.509	0.492
Colon Wall	0.855	2.675	1.307	1.671	4.684	1.83E-06	1.384	0.426
Bladder	1.690	5.269	2.586	3.262	8.949	3.58E-06	2.589	0.803
Lungs	0.281	0.875	0.474	0.603	1.610	1.02E-06	0.459	0.160
Bone	0.350	1.094	0.636	0.807	2.169	2.09E-06	0.562	0.203
Liver	0.389	1.228	0.706	0.889	2.081	1.66E-06	0.617	0.222
Thyroid	0.350	1.066	0.569	0.718	2.314	1.48E-06	0.583	0.210
Esophagus	0.218	0.679	0.319	0.404	1.155	4.76E-07	0.337	0.118
Skin	0.403	1.254	0.682	0.867	2.379	1.81E-06	0.663	0.201
Other	0.273	0.829	0.415	0.525	1.429	6.51E-07	0.414	0.141
Breast	1.368	4.239	2.644	3.353	9.050	8.49E-06	2.339	0.850
Total	7.333	22.715	12.212	15.494	42.994	2.68E-05	11.850	3.935

Table M.19 Absorbed Dose to Organs for an Adipose Female Healthcare Provider from Adipose Female Patient for Internal Contamination ($\mu\text{Gy/hr}$) /ALI

Organ	^{60}Co (s)	^{60}Co (m)	^{192}Ir (s)	^{192}Ir (m)	^{192}Ir (f)	^{241}Am	^{137}Cs	^{131}I
Gonads	0.183	0.778	0.394	0.497	1.592	6.82E-07	0.366	0.119
Stomach	0.715	2.980	1.761	2.240	6.650	4.21E-06	1.622	0.555
Colon Wall	0.678	2.930	1.427	1.808	6.100	2.14E-06	1.417	0.456
Bladder	1.318	5.740	2.826	3.549	11.993	4.24E-06	2.600	0.833
Lungs	0.219	0.941	0.526	0.665	2.087	1.22E-06	0.478	0.174
Bone	0.265	1.146	0.675	0.854	2.719	2.39E-06	0.575	0.214
Liver	0.298	1.310	0.781	0.982	3.320	1.98E-06	0.641	0.241
Thyroid	0.243	1.039	0.642	0.803	2.429	1.88E-06	0.601	0.231
Esophagus	0.176	0.737	0.351	0.435	1.452	5.38E-07	0.372	0.127
Skin	0.312	1.353	0.757	0.958	3.128	2.16E-06	0.688	0.218
Other	0.209	0.923	0.448	0.574	1.819	8.02E-07	0.437	0.158
Breast	1.054	4.527	2.936	3.723	11.778	1.02E-05	2.434	0.928
Total	5.670	24.405	13.525	17.087	55.066	3.24E-05	12.232	4.254

Table M.20 Absorbed Dose to Organs for an Adipose Female Healthcare Provider from Postmenopausal Adipose Female Patient for Internal Contamination ($\mu\text{Gy/hr}$) /ALI

Organ	^{60}Co (s)	^{60}Co (m)	^{192}Ir (s)	^{192}Ir (m)	^{192}Ir (f)	^{241}Am	^{137}Cs	^{131}I
Gonads	0.183	0.809	0.375	0.462	1.174	5.37E-07	0.625	0.115
Stomach	0.690	2.872	1.660	2.117	6.131	3.72E-06	2.393	0.520
Colon Wall	0.651	2.830	1.356	1.730	4.689	2.00E-06	2.308	0.444
Bladder	1.245	5.431	2.728	3.447	8.741	4.03E-06	4.240	0.811
Lungs	0.212	0.913	0.497	0.629	1.644	1.09E-06	0.715	0.163
Bone	0.257	1.112	0.654	0.826	2.170	2.17E-06	0.889	0.206
Liver	0.288	1.262	0.737	0.924	2.045	1.76E-06	0.948	0.227
Thyroid	0.241	1.044	0.640	0.802	2.253	1.70E-06	0.920	0.218
Esophagus	0.159	0.687	0.343	0.434	1.130	4.13E-07	0.544	0.114
Skin	0.301	1.298	0.720	0.911	2.389	1.93E-06	1.034	0.208
Other	0.209	0.892	0.414	0.525	1.491	7.10E-07	0.684	0.146
Breast	1.030	4.405	2.798	3.543	9.109	9.19E-06	3.491	0.873
Total	5.467	23.556	12.920	16.350	42.966	2.93E-05	18.789	4.046

Table M.21 Absorbed Dose to Organs for a Postmenopausal Adipose Female Healthcare Provider from Reference Male Patient for Internal Contamination ($\mu\text{Gy/hr}$) /ALI

Organ	^{60}Co (s)	^{60}Co (m)	^{192}Ir (s)	^{192}Ir (m)	^{192}Ir (f)	^{241}Am	^{137}Cs	^{131}I
Gonads	0.363	1.515	0.780	0.874	2.238	9.22E-07	0.724	0.247
Stomach	0.637	2.646	1.645	1.861	5.105	3.54E-06	1.301	0.488
Colon Wall	0.604	2.637	1.377	1.607	4.032	1.83E-06	1.241	0.431
Bladder	1.180	5.083	2.676	3.128	7.965	3.74E-06	2.317	0.798
Lungs	0.225	0.954	0.560	0.674	1.572	1.29E-06	0.445	0.170
Bone	0.271	1.164	0.744	0.892	2.165	2.69E-06	0.559	0.221
Liver	0.286	1.251	0.741	0.904	1.786	1.86E-06	0.567	0.222
Thyroid	0.404	1.729	1.068	1.320	3.299	3.44E-06	0.844	0.338
Esophagus	0.182	0.781	0.375	0.464	1.165	5.22E-07	0.327	0.118
Skin	0.293	1.251	0.751	0.896	2.185	2.18E-06	0.608	0.227
Other	0.201	0.837	0.473	0.558	1.330	7.63E-07	0.411	0.144
Breast	1.049	4.429	3.071	3.735	8.467	1.15E-05	2.171	0.898
Total	5.696	24.276	14.262	16.911	41.310	3.43E-05	11.516	4.303

Table M.22 Absorbed Dose to Organs for a Postmenopausal Adipose Female Healthcare Provider from Reference Female Patient for Internal Contamination ($\mu\text{Gy/hr}$) /ALI

Organ	^{60}Co (s)	^{60}Co (m)	^{192}Ir (s)	^{192}Ir (m)	^{192}Ir (f)	^{241}Am	^{137}Cs	^{131}I
Gonads	0.581	1.766	0.750	0.953	2.362	8.20E-07	0.846	0.205
Stomach	0.955	2.872	1.632	2.064	5.558	4.11E-06	1.219	0.504
Colon Wall	0.892	2.792	1.352	1.702	4.215	2.10E-06	1.403	0.418
Bladder	1.708	5.347	2.554	3.218	7.889	3.72E-06	2.714	0.763
Lungs	0.321	0.988	0.561	0.709	1.665	1.40E-06	0.515	0.181
Bone	0.380	1.177	0.712	0.900	2.189	2.73E-06	0.623	0.219
Liver	0.412	1.304	0.768	0.961	1.889	2.00E-06	0.815	0.238
Thyroid	0.579	1.722	1.072	1.340	3.334	3.37E-06	0.901	0.356
Esophagus	0.247	0.794	0.381	0.481	1.239	6.30E-07	0.358	0.126
Skin	0.422	1.303	0.750	0.945	2.244	2.36E-06	0.704	0.228
Other	0.287	0.869	0.447	0.579	1.373	7.99E-07	0.430	0.156
Breast	1.502	4.579	3.082	3.876	9.029	1.24E-05	2.542	0.930
Total	8.287	25.513	14.062	17.727	42.986	3.64E-05	13.070	4.324

Table M.23 Absorbed Dose to Organs for a Postmenopausal Adipose Female Healthcare Provider from Adipose Male Patient for Internal Contamination ($\mu\text{Gy/hr}$) /ALI

Organ	^{60}Co (s)	^{60}Co (m)	^{192}Ir (s)	^{192}Ir (m)	^{192}Ir (f)	^{241}Am	^{137}Cs	^{131}I
Gonads	0.469	1.516	0.602	0.774	2.279	7.01E-07	0.673	0.219
Stomach	0.825	2.466	1.351	1.732	5.365	2.67E-06	1.343	0.440
Colon Wall	0.778	2.471	1.149	1.455	4.115	1.43E-06	1.236	0.386
Bladder	1.496	4.700	2.210	2.811	7.749	2.85E-06	2.199	0.684
Lungs	0.275	0.853	0.452	0.572	1.540	9.15E-07	0.439	0.154
Bone	0.338	1.057	0.618	0.783	2.102	1.90E-06	0.546	0.198
Liver	0.369	1.171	0.653	0.821	1.909	1.43E-06	0.582	0.207
Thyroid	0.492	1.504	0.841	1.044	3.182	1.97E-06	0.839	0.313
Esophagus	0.201	0.618	0.316	0.401	1.112	3.89E-07	0.323	0.105
Skin	0.367	1.146	0.622	0.789	2.169	1.64E-06	0.604	0.201
Other	0.251	0.793	0.375	0.486	1.354	5.33E-07	0.381	0.247
Breast	1.274	3.950	2.480	3.142	8.492	7.95E-06	2.179	0.792
Total	7.136	22.245	11.670	14.809	41.368	2.44E-05	11.345	3.945

Table M.24 Absorbed Dose to Organs for a Postmenopausal Adipose Female Healthcare Provider from Adipose Female Patient for Internal Contamination ($\mu\text{Gy/hr}$) /ALI

Organ	^{60}Co (s)	^{60}Co (m)	^{192}Ir (s)	^{192}Ir (m)	^{192}Ir (f)	^{241}Am	^{137}Cs	^{131}I
Gonads	0.512	1.627	0.696	0.863	2.923	7.73E-07	0.746	0.235
Stomach	0.921	2.759	1.540	1.969	5.739	3.42E-06	1.465	0.499
Colon Wall	0.845	2.637	1.251	1.580	5.376	1.66E-06	1.268	0.413
Bladder	1.633	5.110	2.410	3.047	10.251	3.10E-06	2.363	0.736
Lungs	0.296	0.918	0.505	0.640	2.009	1.14E-06	0.461	0.168
Bone	0.356	1.112	0.656	0.830	2.635	2.17E-06	0.559	0.209
Liver	0.393	1.243	0.717	0.901	3.067	1.69E-06	0.600	0.225
Thyroid	0.504	1.565	0.869	1.084	3.346	2.33E-06	0.832	0.326
Esophagus	0.231	0.722	0.322	0.408	1.271	5.65E-07	0.320	0.114
Skin	0.395	1.229	0.689	0.872	2.850	1.99E-06	0.629	0.218
Other	0.284	0.869	0.425	0.545	1.758	6.87E-07	0.400	0.150
Breast	1.363	4.213	2.751	3.487	3.487	9.65E-06	2.272	0.865
Total	7.732	24.004	12.833	16.225	44.713	2.92E-05	11.915	4.156

Table M.25 Absorbed Dose to Organs for a Postmenopausal Adipose Female Healthcare Provider from Postmenopausal Adipose Female Patient for Internal Contamination ($\mu\text{Gy/hr}$)/ALI

Organ	^{60}Co (s)	^{60}Co (m)	^{192}Ir (s)	^{192}Ir (m)	^{192}Ir (f)	^{241}Am	^{137}Cs	^{131}I
Gonads	0.506	1.573	0.679	0.867	2.085	6.24E-07	1.214	0.205
Stomach	0.873	2.633	1.448	1.846	5.522	3.00E-06	2.162	0.473
Colon Wall	0.817	2.566	1.189	1.502	4.176	1.54E-06	2.071	0.391
Bladder	1.559	4.887	2.314	2.909	7.323	3.04E-06	3.726	0.698
Lungs	0.287	0.890	0.473	0.599	1.564	9.78E-07	0.703	0.157
Bone	0.347	1.080	0.633	0.802	2.096	1.96E-06	0.859	0.201
Liver	0.380	1.202	0.680	0.852	1.869	1.50E-06	0.896	0.211
Thyroid	0.481	1.488	0.831	1.053	3.003	2.20E-06	1.270	0.306
Esophagus	0.218	0.693	0.324	0.406	1.182	4.25E-07	0.516	0.107
Skin	0.382	1.187	0.657	0.831	2.172	1.78E-06	0.945	0.208
Other	0.259	0.792	0.379	0.488	1.340	5.74E-07	0.617	0.128
Breast	1.327	4.090	2.615	3.314	8.508	8.63E-06	3.247	0.818
Total	7.436	23.080	12.223	15.469	40.840	2.63E-05	18.227	3.904

REFERENCES

1. Bridges, A.H., Estimating the Radiation Dose to Emergency Room Personnel in an Event of a Radiological Dispersal Device Explosion. Georgia Institute of Technology, August 2005.
2. International Commission on Radiological Protection (ICRP). (1975). Report of the Task Group on Reference Male. ICRP Publication 23.
3. International Commission on Radiological Protection (ICRP). (1991). Recommendations of the ICRP. ICRP Publication 60. Annals of the ICRP, Volume 21, No. 1-3.
4. J.E. Martin and Chul Lee, Principles of Radiological Health and Safety. John Wiley Sons, Inc. Hoboken, New Jersey 2003 pg 286-291.
5. National Council on Radiation Protection and Measurements (NCRP). (1993). Limitation of Exposure to Ionizing Radiation. Report No. 116.
6. N. E. Hertel, R. W. Simpkins, Neutron Organ Dose and the Influence of Adipose Tissue.
7. R.J. Traub, P.C. Olsen, and J.C. McDonald “The Radiological Properties of a Novel Lung Tissue Substitute” Radiation Protection Dosimetry Volume 121 No 2 2006 pg 203 Oxford University Press, Oxford, UK.
8. Smith, J., Ansari, A., Harper, F., Hospital management of Mass Radiological casualties: Reassessing Exposures from Contaminated Victims of an Exploded Radiological Dispersal Device. Health Physics Journal Volume 89 Number 5, November 2005.
9. Stainless Steel – Grade304. On-line. Available from Internet, <http://www.azom.com/details.asp?ArticleID=965>, accessed 1 October 2007.
10. U.S. Nuclear Regulatory Commission. 2007. Annual Limit on Intake (ALI). On-line. Available from Internet, <http://www.nrc.gov/reading-rm/basic-ref/glossary/annual-limit-on-intake-ali.html>, accessed 9 December 2007.
11. X-5 Monte Carlo Team. (2003). MCNP – A General Monte Carlo N-Particle Transport Code, Version 5. LA-UR-03-1987.
12. K. F. Eckerman, R. W. Leggett, M. Cristy, C. B. Nelson, J. C. Ryman, A. L. Sjoreen, and R. C. Ward. User's Guide to the DCAL System. ORNL/TM-2001/190, Oak Ridge National Laboratory. 2006.
13. Eckerman, K.F. and A.L. Sjoreen, Radiological Toolbox User’s Manual. ORNL/TM-2004/27, Oak Ridge National Laboratory. 2003.

14. Tanner, J.E. Current Dose Studies on Effective Neutron Dose Equivalent. Eleventh DOE Workshop on Personnel Neutron Dosimetry. Las Vegas, Nevada: June 3-7, 1991. pg 173-191.
15. Mathematica Version 6. Wolfram Research, Inc., 2007.
16. Code of Federal Regulations. Volume 10 Part 20 Subpart C. U.S. Government Printing Office, Washington: 1998. pg 291.
17. Loevinger, R. and M. Berman. NM/MIRD Phaphlet No 1, Revised. Society of Nuclear Medicine. New York, 1976.
18. Hatice Akkurt, Keith F. Eckerman. Development of PIMAL: Mathematical Phantom with Moving Arms and Legs. ORNL/TM-2007/14, Oak Ridge National Laboratory. 2007.
19. Amirshaybani, H.R. et al. The Natural History of the Growth of the Hand: I. Hand Area as a Percentage of Body Surface Area. <http://www.ncbi.nlm.nih.gov/pubmed/11304598>. 2001.
20. International Commission on Radiological Protection (ICRP). (1996). Age-dependent Doses to the Members of the Public from Intake of Radionuclides Part 5, Compilation of Ingestion and Inhalation Coefficients. ICRP Publication 72. Annuals of the ICRP, Volume 26/1.