

**EFFECT OF OZONATION AND BAC FILTRATION PROCESSES ON
MONOCHLORAMINE DEMAND**

A Thesis
Presented to
The Academic Faculty

By

Saurabh Marda

In Partial Fulfillment
of the Requirements for the Degree
Masters of Science in Environmental Engineering

Georgia Institute of Technology

May, 2005

EFFECT OF OZONATION AND BAC FILTRATION PROCESSES ON
MONOCHLORAMINE DEMAND

Approved by:

Dr. Jaehong Kim, Advisor
School of Civil and Environmental Engineering
Georgia Institute of Technology

Dr. Ching-Hua Huang
School of Civil and Environmental Engineering
Georgia Institute of Technology

Dr. E. Michael Perdue
Earth & Atmospheric Sciences
Georgia Institute of Technology

Date Approved: 4-13-05

To my mother and father who have taught me and given me more than I can ever repay
them

ACKNOWLEDGEMENT

I would like to thank Dr. Jaehong Kim for his guidance and support throughout the course of my time at Georgia Tech. I also gratefully acknowledge the insight and suggestions provided by Dr. Appiah Amirtharajah and Dr. Mike Perdue for this work. I would especially like to thank Dooil Kim for all his advice and help throughout this project. Thanks also to my thesis committee members – Dr. Ching-Hua Huang and Dr. Mike Perdue for their valuable inputs. I further acknowledge the assistance provided by everyone at the David L. Tippin Plant, Tampa, Fl and the Tampa Bay Surface Water Treatment (TBSWT) Plant, Tampa, Fl without which the results included here would not have been possible.

TABLE OF CONTENTS

ACKNOWLEDGEMENTS	iv
LIST OF TABLES	vi
LIST OF FIGURES	vii
LIST OF SYMBOLS AND ABBREVIATIONS	x
SUMMARY	xii
CHAPTER 1 INTRODUCTION	1
CHAPTER 2 BACKGROUND	3
2.1 David L. Tippin Water Treatment Plant, Tampa, FL	3
2.2 Tampa Bay Surface Water Treatment Plant, Tampa, FL.....	5
CHAPTER 3 LITERATURE REVIEW	6
CHAPTER 4 MATERIALS AND METHODS.....	14
CHAPTER 5 RESULTS AND DISCUSSION.....	18
5.1 Effect of Ozonation.....	18
5.2 Effect of BAC Filtration	20
CHAPTER 6 CONCLUSIONS	26
REFERENCES	50

LIST OF TABLES

Table 1. Design criteria of the Tampa Bay Surface Water Treatment (TBSWT) plant biological activated carbon (BAC) filter.....28

Table 2. Comparison of the filter backwashing process at the David L. Tippin (DLT) plant and the Tampa Bay Surface Water Treatment (TBSWT) plant.....28

LIST OF FIGURES

Figure 1. Process schematics of the DLT plant	29
Figure 2. Coagulation and sedimentation schematic basin at the DLT plant	30
Figure 3. Schematic of the Ozone contactor at the DLT plant	30
Figure 4. Cross sectional schematic of a biological activated carbon filter at the DLT plant.....	31
Figure 5. Wheeler type underdrain system used at the DLT Plant. a) Upper view of underdrain system, b) Side view of the underdrain system	31
Figure 6. Process Schematic of the Thermal Optical Transmittance (TOT) instrument	32
Figure 7. Sample Thermogram created by the Thermal Optical Transmitter	32
Figure 8. Effect of Labscale Ozonation at pH 6.5 on chloramine demand of Suwannee River natural organic matter (NOM). Ozonation carried out at varying Ozone/TOC ratios. Initial total organic carbon (TOC) concentration in all cases is 1.95mg/l. In all cases, initial $[\text{NH}_2\text{Cl}] = 10\text{mg/l}$ as Cl_2 , $\text{Cl/N } 0.7$ (mol/mol), $C_{\text{T,CO}_3} = 5\text{mM}$, $\text{pH} = 6.5$, $T = 25^\circ\text{C}$	33
Figure 9. Effect of Labscale Ozonation at pH 7.5 on chloramine demand of Suwannee River natural organic matter (NOM). Ozonation carried out at varying Ozone/TOC ratios. Initial total organic carbon (TOC) concentration in all cases is 1.95mg/l. In all cases, initial $[\text{NH}_2\text{Cl}] = 10\text{mg/l}$ as Cl_2 , $\text{Cl/N } 0.7$ (mol/mol), $C_{\text{T,CO}_3} = 5\text{mM}$, $\text{pH} = 7.5$, $T = 25^\circ\text{C}$	34
Figure 10. Effect of Labscale Ozonation at pH 8.5 on chloramine demand of Suwannee River natural organic matter (NOM). Ozonation carried out at varying Ozone/TOC ratios.	

Initial total organic carbon (TOC) concentration in all cases is 1.95mg/l. In all cases, initial [NH ₂ Cl] = 10mg/l as Cl ₂ , Cl/N 0.7 (mol/mol), C _{T,CO3} = 5mM, pH = 8.5, T = 25°C.....	35
Figure 11. Effect of ozonation on the chloramine demand of the coagulated and settled water at the DLT plant. For samples collected on May 11 th , 2004, Ozone/TOC ratio ≈ 1 and for the samples collected on September 25 th , 2004, Ozone/TOC ratio ≈ 0.5. In all cases, initial [NH ₂ Cl] = 10mg/l as Cl ₂ , Cl/N 0.7 (mol/mol), no buffer added, T = 25°C.....	36
Figure 12. Chloramine demand exerted by DLT plant BAC filter effluent samples (September 25 th , 2004). In all cases, initial [NH ₂ Cl] = 10mg/l as Cl ₂ , Cl/N 0.7 (mol/mol), no buffer added, T = 25°C	37
Figure 13. Effect of Heterotrophic plate count (HPC) on the amount of chloramine consumed in ≈ 97 hr by the BAC filter effluent (September 25 th , 2004), obtained from the DLT plant. In all cases, initial [NH ₂ Cl] = 10mg/l as Cl ₂ , Cl/N 0.7 (mol/mol), no buffer added, T = 25°C	38
Figure 14. Chloramine demand exerted by buffered Milli-Q water containing Calgon Corp. Filtrasorb 300 granular activated carbon fines (GAC). In all cases, initial [NH ₂ Cl] = 10mg/l as Cl ₂ , Cl/N 0.7 (mol/mol), C _{T,CO3} = 5mM, T = 25°C.....	39
Figure 15. Chloramine demand exerted by post ozonated sample (May 11 th , 2004) obtained from the DLT plant, containing Calgon Corp. Filtrasorb 300 granular activated carbon (GAC) fines. In all cases, initial [NH ₂ Cl] = 10mg/l as Cl ₂ , Cl/N 0.7 (mol/mol), no buffer added, pH = 7.47, TOC = 2.11mg/l, T = 25°C.....	40
Figure 16. Chloramine demand exerted by buffered Milli-Q water containing Calgon Corp. WPL type powdered activated carbon (PAC). In all cases, initial [NH ₂ Cl] = 10mg/l as Cl ₂ , Cl/N 0.7 (mol/mol), C _{T,CO3} = 5mM, pH = 8, T = 25°C.....	41
Figure 17. Chloramine demand exerted by post ozonated sample (May 11 th , 2004) obtained from the DLT plant, containing Calgon Corp. WPL type powdered activated carbon (PAC). In all cases, initial [NH ₂ Cl] = 10mg/l as Cl ₂ , Cl/N 0.7 (mol/mol), no buffer added, pH = 7.47, TOC = 2.11mg/l, T = 25°C.....	42
Figure 18. Comparison of the chloramine demand of the DLT plant BAC filter effluent (May 11 th , 2004) obtained 5 min after backwashing with the chloramine demand of the same sample further filtered using a 0.4µm and 1.2µm polycarbonate membrane filter	

(PCF). In all cases, initial $[\text{NH}_2\text{Cl}] = 10\text{mg/l}$ as Cl_2 , $\text{Cl/N } 0.7$ (mol/mol), no buffer added, $T = 25^\circ\text{C}$43

Figure 19. Comparison of the chloramine demand of the DLT plant BAC filter effluent (May 11th, 2004) obtained 10 min after backwashing with the chloramine demand of the same sample further filtered using a $0.4\mu\text{m}$ and $1.2\mu\text{m}$ polycarbonate membrane filter. In all cases, initial $[\text{NH}_2\text{Cl}] = 10\text{mg/l}$ as Cl_2 , $\text{Cl/N } 0.7$ (mol/mol), no buffer added, $T = 25^\circ\text{C}$44

Figure 20. Comparison of the chloramine demand of the DLT plant BAC filter effluent (May 11th, 2004) obtained 15 min after backwashing with the chloramine demand of the same sample further filtered using a $0.4\mu\text{m}$ and $1.2\mu\text{m}$ polycarbonate membrane filter. In all cases, initial $[\text{NH}_2\text{Cl}] = 10\text{mg/l}$ as Cl_2 , $\text{Cl/N } 0.7$ (mol/mol), no buffer added, $T = 25^\circ\text{C}$45

Figure 21. Comparison of the chloramine demand of the DLT plant BAC filter effluent (May 11th, 2004) obtained 30 min after backwashing with the chloramine demand of the same sample further filtered using a $0.4\mu\text{m}$ and $1.2\mu\text{m}$ polycarbonate membrane filter. In all cases, initial $[\text{NH}_2\text{Cl}] = 10\text{mg/l}$ as Cl_2 , $\text{Cl/N } 0.7$ (mol/mol), no buffer added, $T = 25^\circ\text{C}$46

Figure 22. Comparison of the chloramine demand of the $0.4\mu\text{m}$ polycarbonate membrane filtered DLT Plant BAC filter influent (May 11th, 2004) and effluent. In all cases, initial $[\text{NH}_2\text{Cl}] = 10\text{mg/l}$ as Cl_2 , $\text{Cl/N } 0.7$ (mol/mol), no buffer added, $T = 25^\circ\text{C}$47

Figure 23. Comparison of the chloramine demand of the $1.2\mu\text{m}$ polycarbonate membrane filtered DLT Plant BAC filter influent (May 11th, 2004) and effluent. In all cases, initial $[\text{NH}_2\text{Cl}] = 10\text{mg/l}$ as Cl_2 , $\text{Cl/N } 0.7$ (mol/mol), no buffer added, $T = 25^\circ\text{C}$48

Figure 24. Chloramine demand exerted by BAC filter influent and effluent samples (September 28th, 2004), Tampa Bay Surface Water Treatment (TBSWT) Plant, collected after filter backwashing. Initial $[\text{NH}_2\text{Cl}] = 10\text{mg/l}$ as Cl_2 , $\text{Cl/N } 0.7$ (mol/mol), no buffer added, $T = 25^\circ\text{C}$ $[\text{NH}_2\text{Cl}] = 10\text{mg/l}$ as Cl_2 , $\text{Cl/N } 0.7$ (mol/mol), no buffer added, $T = 25^\circ\text{C}$49

LIST OF ABBREVIATIONS AND SYMBOLS

ACS – American Chemical Standard

BAC – Biologically activated carbon

CC – Carbonate carbon

CT, CO₃ – Total carbonate concentration

DLT - David L. Tippin

DLTWTF - David L. Tippin Water Treatment Facility

DPD – Diethyl phenylene diamine

EBCT – Empty bed contact time

EC – Elemental carbon

FAS – Ferrous ammonium sulfate

FID – Flame ionization detectors

GAC – Granular activated carbon

HPC – Heterotrophic plate count

NOM – Natural organic matter

OC – Organic carbon

PAC- Powdered activated carbon

PC – Pyrolysed carbon

PCF – Poly carbonate filter

TBSWT - Tampa Bay Surface Water Treatment

TOC – Total organic carbon

TOT – Thermal optical transmittance

SUMMARY

Maintaining a stable disinfectant residual in drinking water distribution systems is a primary concern of the drinking water industry. To achieve this, treatment plants use secondary disinfectants, such as monochloramine. Although the kinetics and mechanism of decay of monochloramine in organic-free waters are relatively well understood, those in natural waters are not, due to exceedingly complex and poorly defined interactions of monochloramine with dissolved natural organic matter (NOM) and particulate matter. In addition, alteration of physical and chemical characteristics of NOM and particulate matter during treatment processes adds further complication. Ozonation followed by biologically activated carbon (BAC) filtration is a commonly practiced process option that affects the characteristics of both dissolved and particulate constituents in the water. The effect of these changes in water constituents on the stability of monochloramine is currently unknown.

The kinetics of monochloramine decay were measured under varying conditions on water samples obtained before and after ozonation and BAC treatments. The tested waters include the natural water sampled from David L. Tippin Water Treatment Facility (DLTWTF), Tampa, FL, Tampa Bay Surface Water Treatment (TBSWT) Plant, Tampa, FL and laboratory synthetic water prepared with reference Suwannee River NOM.

The effect of ozonation on monochloramine stability was investigated using both the water samples from the full-scale plant and the synthetic water prepared with Suwannee River NOM. Ozonation of NOM resulted in changes in the stability of chloramine. Previous studies in this area have reported that ozonation lead to an increase in the chloramine demand. Experiments performed in this study show that ozonation does not always result in an increased chloramine demand. The effect of ozonation on chloramine demand was found to depend on many factors such as pH, Ozone/TOC ratio, properties of natural organic matter, etc.

The stability of monochloramine in the biological activated carbon (BAC) filter effluent samples obtained at different times after backwashing was determined. It was found that in most cases monochloramine stability was greatly decreased after BAC filtration. Further filtering the BAC effluents with 1.2 μm polycarbonate membrane resulted in a substantial increase in monochloramine stability. A further increase was observed after filtering the samples using a 0.4 μm membrane. This finding suggested that particulate matter generated from the filters could be the major cause of monochloramine instability. The particulates from activated carbon, possible components of the particulate matter eluting from the BAC filters, were found to exert an insignificant monochloramine demand both in the presence and absence of NOM, which is contrary to previous speculation in the literature about their demand for monochloramine. Preliminary studies show monochloramine demand in the BAC filter effluent to be a function of the heterotrophic plate count (HPC) count. A longer filter backwash time and a shorter filter

run period resulted in the BAC filter effluent having almost the same chloramine demand as the BAC filter influent.

CHAPTER 1

INTRODUCTION

Maintaining a stable disinfectant residual in the drinking water distribution systems is a primary concern of the drinking water industry. To achieve this, treatment plants use secondary disinfectants, such as monochloramine which are more stable than primary disinfectants such as free chlorine. Monochloramine is produced by a reaction between free chlorine and ammonia in a process called chloramination. Strictly speaking, monochloramine consists of monochloramine (NH_2Cl), dichloramine (NHCl_2) and trichloramine (NCl_3). However, monochloramine is the predominant chloramine species in the conditions typically found in water treatment facilities.

Although the kinetics and mechanism of decay of monochloramine in organic-free waters are relatively well understood, those in natural waters are not, due to exceedingly complex and poorly defined interactions of monochloramine with dissolved natural organic matter (NOM) and particulate matter. In addition, alteration of physical and chemical characteristics of NOM and particulate matter during the treatment processes adds further complication. Ozonation followed by biologically activated carbon (BAC) filtration is a commonly practiced process option that affects the characteristics of both dissolved and particulate constituents in the water. However, how these changes in water constituents affect stability of the residual disinfectant, or monochloramine in particular, are currently unknown.

The objective of this study was to elucidate the factors affecting monochloramine stability during ozonation and BAC filtration processes using both field waters samples and laboratory synthetic waters.

CHAPTER 2

BACKGROUND

2.1 David L. Tippin Water Treatment plant, Tampa, FL

The process schematics of David L. Tippin (DLT) water treatment plant are flocculation/sedimentation, Actiflo, ozonation, BAC filter, and clear well (Fig. 1). To treat turbidity, both conventional coagulation and Actiflo system are used together. After this process, the coagulated and settled waters are then passed through the ozonation chambers. Ozonated water is mixed with chemicals such as NaOH, liquid polymer, and fluoride at the pre-filtration junction box and then passed through the BAC filter. The biologically treated water is mixed with chlorine and ammonia to create chloramines and then sent to the clear well in the final stage.

Conventional Coagulation Process Almost 70% of influent water is treated by the conventional coagulation process (Fig. 2). This process has two trains. Each train has four coagulation basins and two sedimentation basins. Ferric sulfate is used as a primary coagulant and dry non-ionic polymer is injected as a coagulant at the 3rd tank of coagulation basin. The pH during the coagulation process is maintained at 4.5 by adding sulfuric acid. At this pH, Fe^{3+} is most soluble and has a strong colloidal destabilization potential. Floes formed in the flocculation basin precipitate in the following sedimentation basin. The sludge deposited at the bottom of this basin is taken out of the basin by the pump installed at the traveling bridge. The operation period of this bridge is

once a day. At the end of the basin, powdered lime ($\text{Ca}(\text{OH})_2$) is added to the coagulated and settled waters to increase their pH to 6~7 before entering the ozone contactors. There is also a provision to add sodium hydroxide (NaOH) to raise the pH of the sample entering the ozone contactors.

Ozonation Ozone contactors are composed of two trains of chambers and each train is composed of eight chambers (Fig. 3). Ozone is injected into 1st, 2nd, and 6th chambers with the highest amount of ozone injected at the 1st stage. Ozone is generated from pure oxygen and its weight-based content is 6.55%. Ozone concentration is measured in the 2nd and the 4th chambers. On the day of this study, ozone concentration was found to be 0.42 mg O_3/L in the 2nd chamber and 0.16mg O_3/L at in 4th chamber. Hydrogen peroxide can be added at the 5th chamber for enhanced oxidation.

Biological Activated Carbon Filter The entire filtration setup consists of 30 filters, with each filter consisting of two cells (Fig. 4). The surface area of each cell is different, varying from 16x32 ft² to 10x30 ft². Filter media is sand and GAC. The sand/GAC ratio is 1:2 with the GAC on the higher layer and sand on the lower layer of the filter. The effective size of sand is 0.45 ~ 0.55 mm and that of GAC is 0.8 ~ 1.0 mm. The underdrain system is Wheeler type (Fig. 5). The design empty bed contact time (EBCT) is 4.5 minutes and design filtration rate is 3.11 gpm/ft². Chemicals such as chlorine, sodium hydroxide, hydrogen peroxide, sodium bisulfite, potassium permanganate and liquid polymer can be used before filtration depending on the operating conditions. Prechlorination is used as a backup for ozone disinfection in case of problems with the

ozone generator. Hydrogen peroxide and sodium bisulfite are used to quench the remaining ozone before BAC filtration. Permanganate can be used to carry out additional oxidation of organic matter. Liquid polymer is used to control the turbidity of filters. Backwashing is done with air and water. Backwashing on each filter is carried out after 50-60 hours of filter run time.

2.2 Tampa Bay Surface Water Treatment (TBSWT) Plant, Tampa, FL

Samples were taken from the TBSWT plant to compare the effect different BAC filter backwash procedure and filter run time had on the chloramine demand of the filter effluent at this plant.

The characteristics of the raw water entering the TBSWT plant are slightly different from that entering the DLT plant. At the TBSWT plant, Actiflo was used to treat all the coagulated waters. Ozonation at Ozone/TOC ratio of 1 is carried out at the this plant following the Actiflo process. The ozonation pH is around 5.6. The ozonated samples were then passed through the BAC filters. There are 8 filters (Table 1) at this plant. The filters at this plant are larger in size compared to the BAC filters at the DLT plant. The filter run times at the TBSWT plant are approximately 24 hours.

CHAPTER 3

LITERATURE REVIEW

Chloramines are used to provide a disinfectant residual in distribution systems where free chlorine residuals are difficult to maintain or they lead to the formation of excessive trihalomethane (THM). Monochloramine has the same oxidizing capacity as free chlorine on a chlorine atom basis but is a weaker disinfectant (Wolfe et al, 1984). Chloramines are produced by a reaction between free chlorine and ammonia in a process called chloramination. Strictly speaking, chloramines consist of monochloramine (NH_2Cl), dichloramine (NHCl_2) and trichloramine (NCl_3). However, monochloramine is the predominant chloramine species in the conditions typically found in water treatment facilities. Although chloramines are believed to be less reactive than free chlorine, they are inherently unstable even in the absence of organic matter decomposing by a complex set of reactions, ultimately resulting in the oxidation of ammonia and reduction of free chlorine (Valentine et al, 1998). The loss of chloramine residual by reaction with itself (autodecomposition) was termed decay while the all other reactions with chloramines (e.g., with natural organic matter (NOM), or reduced inorganic species etc) were termed demand.

Chloramine autodecomposition Monochloramine undergoes autodecomposition which results in the oxidation of ammonia and reduction of active chlorine (Jafvert et al, 1992; Vikesland et al, 1998). A second order rate equation adequately described monochloramine autodecomposition in the absence of oxidisable substances other than

NH₃ (Wilczak et al, 2003). During the course of the decomposition reactions, nitrogen in monochloramine present as N (-III) is preferentially oxidized to N₂ with smaller quantities of NO₃⁻, and possibly one or more minor unidentified products (Vikesland et al, 1998). The net decay reaction is expected to increase the free ammonia concentration by an amount which depends on the specific products formed, as shown for the formation of nitrogen gas and nitrate:



The rate of monochloramine loss by autodecomposition primarily depends on pH, increasing inorganic carbon, temperature, Cl/N ratio and initial NH₂Cl concentration (Valentine et al, 1998). The rate of NH₂Cl decay is expected to increase with decreasing pH due to increased rates of dichloramine formation. The subsequent decomposition of dichloramine results in loss of oxidant (Valentine et al, 1998). The difference in monochloramine decay rate between pH 9 and 8 was smaller than the observed difference between pH 8 and 7.5 (Bone et al, 1999). Carbonate content of water is an important variable in drinking water because it exists in natural water sources. An increase in the carbonate concentration results in an increase in the decay rate of monochloramine. NH₂Cl is more stable at lower temperatures. Increasing the temperature from 4°C to 35°C increased the monochloramine decay rate 6.5-fold at pH 7.5. The rate of monochloramine decay was not a measurable function of ionic strength. The Cl/N ratio affects the free ammonia concentration initially introduced into the system. Decreasing the Cl/N ratio decreased the NH₂Cl decay. Reducing the Cl/N ratio from 0.7 to 0.5 mol/ mol at a pH 6.6 decreased the observed second order rate constant almost 50%. The effect of Cl/N ratio

becomes less severe at higher pH values. At high NH_2Cl concentrations, the value of the decay constant was lower than in the case of lower NH_2Cl concentrations (Valentine et al, 1998).

Maintaining a stable disinfectant residual and minimizing DBP formation in the presence of NOM and other reactants are important goals in water treatment. Typically this is attempted by removing NOM or by treatment that renders it less active.

Chloramine reactions with NOM Several studies have demonstrated that the presence of natural organic matter (NOM) in water accelerates the decay of monochloramine (Fleischaker et al, 1983; Isaac, 1983). NOM reacts directly with monochloramine via redox and substitution reactions and the role of NOM as a catalyst is negligible. The reactions between NOM and monochloramine result in decreased nitrogen gas formation but increased ammonia and increased nitrate (Vikesland et al, 1998). The increased rate of formation of ammonia is of concern because it has been associated with incidences of nitrification in drinking water systems (Vikesland et al, 1998). Higher aromaticity and UV/TOC ratio of NOM can result in a higher monochloramine demand when compared to monochloramine demand of NOM with lower aromaticity and UV/TOC ratio (Valentine et al, 1998). Humic and non-humic fractions are representative of all NOM in water (Yavich et al, 2001). Humic and fulvic acids may catalyze the autodecomposition of monochloramine (Vikesland et al, 1998). Aldrich humic acid has a larger effect on the second-order decay constant than Suwannee river fulvic acid (Valentine et al, 1998). Humic and fulvic acid should not be used as a model NOM because the method of their

isolation from NOM may cause significant changes in their properties (Perdue, M., Personal Communication).

Ozonation followed by biologically activated carbon (BAC) filtration is a commonly practiced process option that affects the characteristics of both dissolved and particulate constituents in the water. These processes result in an alteration of physical and chemical characteristics of NOM and particulate matter during treatment processes.

Effect of ozonation on NOM and chloramine demand The nature and amount of NOM in the water can significantly affect the performance of the ozonation process. The chemical nature of NOM is often dependent on hydrologic and seasonally variable factors such as storm, algal activity etc (Westerhoff et al, 1999). Reacting as an electrophile, ozone preferentially oxidizes electron rich moieties such as aromatic carbon-carbon double bonds and aromatic alcohols (Hoigne and Bader 1979; 1983 a, b; Hoigne 1997). Ozone reacts preferentially with molecular structures that absorb UV light as opposed to completely oxidizing organic carbon to carbon dioxide and water (Amy et al, 1988). It was found that 60% of the ozone is consumed within the first minute of its reaction with NOM. It is possible that, during ozonation, the byproducts of oxidation reactions (e.g., ring cleavage) could lead to the formation of additional reactive sites over time during ozonation. These by products plus the slow- reacting NOM sites, are probably responsible for the ozone decomposition during the second phase (Westerhoff et al, 1999). High ozone dose leads to fragmentation of larger molecules, producing smaller molecules as partial oxidation byproducts (Amy et al, 1988), but very small ozone doses

can promote oxidative coupling and polymerization of organic matter (Duguet et al, 1983). Ozone converts humic substances to non-humic substances and the removal of organic carbon occurs through the oxidation of non-humic substances. Both these reactions can proceed in parallel and the amount of ozone required for the oxidation of non-humic substances is two times greater than that required for the oxidation of humic substances (Yavich et al, 2001). The major simple by product of ozonation is oxalic acid (Edwards et al, 1992). Ozonation at approximately 1:1 O₃/TOC ratio increased the monochloramine demand (Wilczak et al, 2003).

Effect of BAC Filtration and Backwashing Filtration would be expected to be beneficial or neutral to monochloramine stability. Filtration of the ozonated water through biologically active GAC/Sand filter media substantially increased the chloramine demand despite lower TOC, lower biodegradable DOC and low densities of nitrifying bacteria residing in the filter media (Wilczak et al, 2003; Rajbhandari et al, 1999). This was attributed to an unknown agent produced during the GAC filtration (Tokuno et al, 1997), possibly GAC fines, biomass attached to the GAC particles, or metabolites from the bio filters (Tokuno et al, 1999). There is an increased passage of particles through granular filters immediately following backwashing, which is commonly known as the filter ripening period (Amburgey et al, 2003). Some studies have shown that more than 90% of the particles passing through a well operated filter do so during the ripening period (Amirtharajah et al, 1988). Membrane filtration studies suggest that suspended materials shedding from the GAC/Sand biofilters are responsible for excessive chloramine demand in water (Wilczak et al, 2003). The amount of particles released appeared to be

independent of the condition of the GAC (new, old or reactivated) (Stringfellow et al, 1993). Monochloramine reacts slowly with GAC by comparison at which free chlorine and dichloramine react (Kim et al, 1980). The following reactions are shown to take place between monochloramine and GAC:

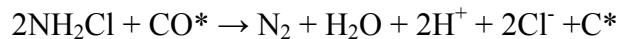
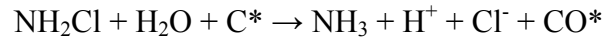

Smaller carbon size and longer contact times result in higher monochloramine consumption. Different types of carbon may exert different types of monochloramine demand (Komorita et al, 1985). Granular activated carbon (GAC) in filter adsorbers provides an excellent support surface for the proliferation of microorganisms. Bacteria proliferate on GAC even with prechlorination because GAC catalyzes the reduction of free chlorine (Camper et al, 1987). Some of the particles released from the GAC filters were populated with attached bacteria. Bacteria clumped together, but not attached to any particles were also found in the filter effluent. Bacteria attached to particles are found to be more resistant to disinfection than the unattached bacteria (Stringfellow et al, 1993). The level of inactivation of bacteria by chloramines was principally dependent upon the disinfectant application technique, solution pH, and the type of bacterial population present at the time of sampling. Bacterial genera surviving 60 min of exposure to pre reacted chloramines included *Acinetobacter*, *Flavobacterium* and *Pseudomonas* (Wolfe et al, 1985). The mode of action of monochloramine in inactivating microorganisms

probably involves an amino acid reaction; however, a nucleic acid reaction cannot be ruled out when the reactive amino acids are unessential or buried (Jacangelo et al, 1984).

Effect of Nitrite Formation of nitrite in chloraminated water is a growing concern in the water industry because it can be produced under conditions that promote biological nitrification of excess added ammonia (Valentine et al, 1998). Nitrite and monochloramine could react to form ammonia and nitrate. The reaction between chloramine and nitrite is relatively slow. Monochloramine does not have to hydrolyze to hypochlorous acid (HOCl) in order to react with nitrite but a direct catalyzed reaction can also take place. Both of these reactions could be a source of monochloramine demand (Margerum et al., 1994). Nitrite up to a concentration of 0.1 mg/l had little effect on monochloramine demand but 0.5 mg/l of nitrite accelerated the monochloramine loss (Valentine et al, 1998).

Effect of Bromide Bromide ion is present in virtually all naturally occurring waters. Even though bromide ion (Br^-) itself has not been regulated, its concentration in distribution system waters is an important concern because of the possible brominated by-products formed during water disinfection. Oxidation of bromide by monochloramine is fast under conditions of chloramination. A comparison of second- order rate constants for the decay of NH_2Cl , in the presence and absence of 0.1 mg/l of bromide, shows that they are almost identical. On the other hand, increasing the bromide concentration to 0.5 mg/l doubles the second order rate constant at pH 7.55. Also, for bromide concentrations ≥ 0.5 mg/l, the decay of NH_2Cl cannot be modeled as second-order decay (Valentine et al, 1998).

Although the kinetics and mechanism of monochloramine decay in organic-free waters are relatively well understood, those in natural waters are not, due to exceedingly complex and poorly defined interactions of monochloramine with natural organic matter (NOM). The focus of this research is on how ozonation followed by BAC filtration affects the chloramine demand of the treated waters.

CHAPTER 3

MATERIALS AND METHODS

Laboratory grade water used for the experiments and for cleaning glassware was produced using a Milli-Q (Millipore, Molsheim, France) system. All the chemicals used in these experiments were American Chemical Standard (ACS) grade or equivalent. The pH of all the solutions was measured with an Accumet AR50 (Fisher Scientific, Pittsburg, PA) after appropriate calibration. To eliminate any free/combined chlorine demand which might be exerted by the compounds adsorbed onto the glassware, all the glassware was cleaned by soaking it in a concentrated chlorine bath (~50 mg/l) for a period of at least 24 hours. After the glassware was cleaned, it was thoroughly rinsed with Milli-Q water and allowed to dry. A temperature of 25°C was maintained in all the monochloramine kinetic experiments using the Julabo Shaking Water Baths SW22 and SW23 (Allentown, PA). Polycarbonate Isopore Membrane Filters (0.4 µm and 1.2 µm, Millipore, Molsheim, France) were used for lab-scale filtration.

The tested waters include the natural water sampled from David L. Tippin Water Treatment Facility (DLTWTF), Tampa, FL and Tampa Bay Surface Water Treatment (TBSWT) Plant, and laboratory synthetic water prepared with reference Suwannee River NOM (IHSS, St. Paul, MN). The natural water samples that were collected from DLTWTF and TBSWT plants were transported and stored at a temperature of 4°C. The samples were not exposed to sunlight.

All the monochloramine kinetic experiments were conducted by diluting a concentrated monochloramine stock solution to a desired concentration. This stock solution was prepared by adding a predetermined amount of sodium bicarbonate (NaHCO_3) to Milli-Q water. The solution pH was adjusted to 9-9.5 by dropwise addition of 0.5M sodium hydroxide (NaOH). Once the pH stabilized, enough NH_4Cl was added to produce an ammonia solution of desired concentration. The solution was mixed using a magnetic stirrer before free chlorine was added. After the designated amount of free chlorine was added, the solution was aged for 60 minutes to complete the free chlorine-ammonia reactions. The final Cl/N molar ratio of the monochloramine stock solution was always 0.7. The solution was stored in the dark. The DPD FAS method was employed for measuring the monochloramine residuals (Standard Methods, 1998).

Stock ozone solution (Kim et al, 2004) was injected into solution aliquots placed in 125 ml amber colored septum capped vials by an airtight syringe (Hammilton, Reno, Nevada). Filtrasorb 300 (Calgon Carbon Corp., Pittsburg, PA) was used as the model GAC fines generated from the filter. The stock solution was prepared by cleaning GAC with synthetic water, making small fragments with mortar and mixing them in synthetic water, then filtering with polycarbonate iso-pore filters having pore sizes 0.8 μm and 5.0 μm . The GAC fines were then quantified after drying the filter at 105°C for 1hr. WPL carbons (Calgon Corp., Pittsburg, PA) were also used as a model carbon generated from the filters. The total organic carbon in the solutions was measured using the Shimadzu TOC-VWS Total Organic Carbon Analyzer (Tokyo, Japan.). Aqueous ozone concentration was measured using the Indigo method (Standard methods, 1998).

To quantify the amount of activated carbon fines from the BAC effluent, a Thermal Optical Transmittance (TOT) instrument (SUNSET Laboratory, Inc.) was used. This instrument measures the contents of organic carbon and elemental carbon by the thermal optical method. Fig.6 shows the schematic diagram of the TOT instrument. The sample is screened by a quartz fiber filter with pore size of 0.3 micron. The sample chamber is heated stepwise to 820°C in an oxygen-free helium condition, thus volatilizing organic carbon. This organic carbon is then catalytically oxidized at 900°C to carbon dioxide. This carbon dioxide is reduced to methane in the Ni/firebrick methanator oven. The methane is quantified by Flame Ionization Detectors (FID). After the organic carbon is quantified, the sample chamber is switched from oxygen-free helium to oxygen-helium mixture condition. The chamber is heated to 860°C stepwise. Under this condition, elemental carbon is oxidized to carbon dioxide which is further reduced to methane and measured by the FID. Figure 7 shows a sample thermogram obtained from TOT machine. Organic carbon (OC) is detected at the first stage before OC-EC split. Carbonate carbon (CC) is also detected at 1st stage but the amount is negligible except that metal ion is binding carbonate. The effect of pyrolysed carbon (PC), which is a remnant of OC pyrolysis, is adjusted by the laser transmittance. After PC is removed by heat, EC is measured.

Total coliforms were measured in accordance with the procedures described in the Standard Methods, 1998, using the spread plate method on a R2A Agar medium. Nitrite

and bromide were measured using Ion Chromatography Dionex DX-600 (Sunnyvale, California).

CHAPTER 4

RESULTS AND DISCUSSION

4.1 Effect of Ozonation

Labscale Ozonation of Suwannee River NOM To study the effect of ozonation on chloramine demand of NOM, lab-scale ozonation of Suwannee River NOM was carried out. These experiments were performed at various pH and Ozone/TOC ratios. In all the ozonation experiments carried out using Suwannee river NOM, a change in the chloramine demand was observed following ozonation. At pH 6.5 (Fig. 8), the initial Ozone/TOC ratio determined if the chloramine demand of the ozonated Suwannee river NOM was higher or lower than the non-ozonated sample. At Ozone/TOC ratio of 0.25, chloramine demand of the ozonated sample was higher than that of the non-ozonated sample. Ozonation at Ozone/TOC ratios of 0.5, 1 and 2 resulted in a decrease in the chloramine demand of the ozonated sample when compared to that of the non-ozonated sample. There was no difference in the chloramine demand exerted by the samples ozonated at Ozone/TOC ratios of 0.5, 1 and 2. At Ozone/TOC ratio of 0.25, the byproducts of oxidation reactions (e.g., ring cleavage) could lead to the formation of additional reactive sites over time during ozonation. The formation of additional reactive sites on the NOM as a result of ozonation could be responsible for the increased chloramine demand. However, at Ozone/TOC ratios of 0.5, 1 and 2, the ozonation byproducts along with the slow reacting NOM sites could be responsible for the decomposition of ozone. This would lead to a net reduction in the number of reactive

sites present on the NOM. This explains the reduced chloramine demand at Ozone/TOC ratios 0.5, 1 and 2 at pH 6.5. At pH 7.5 and 8.5, ozonation resulted in an increased chloramine demand at all Ozone/TOC ratios compared to the chloramine demand of the non ozonated sample (Fig. 9, 10). The highest chloramine demand was once again exerted by the samples that were ozonated at Ozone/TOC ratio of 0.25. However at pH 7.5 and 8.5, ozonation at different Ozone/TOC ratios did not cause a large variation in the chloramine demand of the ozonated samples. Also, the chloramine demand exerted by the samples ozonated at pH 7.5 and 8.5 was found to be similar. These results indicate that at pH 7.5 and 8.5, the additional reactive sites created on the NOM as a result of ozonation were almost the same irrespective of the Ozone/TOC ratio or the initial pH of the solution.

In all the lab-scale ozonation experiments, the only change due to ozonation was in the initial chloramine demand exerted by the NOM. After the initial chloramine demand, chloramine autodecomposition took place. At the same pH, the chloramine autodecomposition rate did not change with a change in the Ozone/TOC ratio. The results of lab-scale ozonation suggest that chloramine demand exerted by the ozonated Suwannee river NOM is a function of the Ozone/TOC ratio especially at a pH 6.5. The pH may determine the oxidizing power and contact time of ozone with the NOM and this could affect the chloramine demand of the ozonated NOM. The role of pH during ozonation needs further investigation.

Effect of plant scale ozonation Ozonated samples of coagulated and settled natural waters that were obtained from the DLT plant during the dry season (May 11th, 2004) and the wet season (September 25th, 2004) exerted varying chloramine demands (Fig. 11). Ozonation of coagulated and settled waters resulted in a decrease in the TOC and an increase in the pH of the post ozonated samples. Similar chloramine demand was exhibited by the pre ozonated samples taken from the DLT plant in the dry and wet season inspite of the fact that they had varying TOC and pH values. For the samples collected in the dry season, ozonation resulted in a clear increase in the chloramine demand. A very small amount of chloramine was lost due to autodecomposition. In the wet season, however, most of the chloramine consumed in both the pre-ozonated and post-ozonated sample was largely due to autodecomposition. At a plant scale, the effect of ozonation on chloramine demand will depend on factors such as nature and amount of NOM, which could vary seasonally, and also the residual metal concentrations. Ozonation might induce increases in residual metal (Fe) concentrations either as soluble metal-organic complexes or as particulates (Jekel, 1989). The effect each of these factors on the chloramine demand of the ozonated samples requires further investigation.

4.2 Effect of BAC Filtration on Monochloramine stability

Filtration of the ozonated water through biologically active GAC/sand media at the DLT plant substantially increased the chloramine demand in spite of lower TOC, lower turbidity and higher pH of the BAC filter effluent (Fig. 12). The chloramine demand of the effluent waters was especially high in the samples collected immediately after

backwashing. The least chloramine demand was exhibited by samples collected between 1 and 3 hrs after backwashing. Researchers have attributed the increased chloramine after BAC filtration to a number of factors such as GAC fines (Skadsen et al., 1993), nitrite, bromide, microorganisms, metabolites etc.

Effect of nitrite and bromide Both nitrite and bromide concentrations of the effluent waters were found to be below 0.1 mg/l. At these concentrations; they are not expected to exert a significant chloramine demand.

Effect of microorganisms BAC filtration resulted in an increase in the HPC of the filter effluent. The HPC of the BAC filter influent was zero. Previous research has shown that granular activated carbon (GAC) in filter adsorbers provide an excellent support surface for the proliferation of microorganisms and that the filter effluent can contain bacteria attached to the particles as well as in clumps unattached to any particles. There appears to be a strong correlation between the HPC and chloramine demand of the filtered effluent (Fig. 13). An increase in the HPC of the filter effluent resulted in a corresponding increase in the amount of chloramine consumed and vice versa. However, the amount of chloramine consumed by the microorganisms might depend not only on the HPC, but also on the type of microorganisms present, whether they are attached to particulate matter or not, etc. Determining the effect of these factors on chloramine demand could result in a more comprehensive understanding of the role played by microorganisms in the increased chloramine demand of the filter BAC filter effluent.

Effect of granular activated carbon (GAC) fines Some researchers have attributed the increased chloramine demand of the BAC filter effluent to GAC fines which could be released into the finished waters from the BAC filters. Chloramine demand of the GAC fines was determined by diluting a concentrated stock solution of the GAC fines to the desired concentration in Milli-Q water. This test was carried out at pH 8, because that is the pH of the BAC filter effluent. Contrary to what was previously reported in literature, GAC fines did not exert any chloramine demand (Fig. 14). Only autodecomposition of chloramine takes place. There has also been speculation about the possibility of GAC fines catalyzing the NOM oxidation by chloramine. To find out if this was the case, GAC fines were added to the post ozonated natural water samples obtained from the DLT plant. Addition of GAC fines to the post ozonated water resulted in a decrease in the chloramine demand (Fig. 15). This was contrary to previous speculation. Preferential adsorption of NOM by the GAC fines could be responsible for this. Due to adsorption of the NOM by the GAC fines, the amount of NOM exerting a demand for chloramine reduces and hence there would be an increase in the chloramine demand.

Effect of powdered activated carbon (PAC) There is a possibility that the GAC fines used in these experiments may not accurately represent the GAC fines generated from the BAC filters at the DLT plant because of the method of their isolation for these experiments. To better understand the role of activated carbon on chloramine demand, WPL carbons (Calgon Corp., Pittsburg, PA) were used as model activated carbon. This is also the same carbon that is used as the GAC media in the BAC filters at the DLT plant. Solutions of desired powdered activated carbon (PAC) concentration were prepared in

Mili-Q water. The chloramine demand exhibited by these samples was negligible up to a PAC concentration of 1mg/l with most of the chloramine being consumed due to autodecomposition (Fig.16). At a 10mg/l PAC concentration, there is a clear chloramine demand exerted by the PAC. However, it is highly unlikely that such high concentrations of PAC could be found in the BAC filter effluent. Thus, it can be concluded that, for the concentration range of PAC that could be found in the BAC filter effluent, it is not responsible for the increased chloramine demand of the BAC filter effluent. To investigate the role of PAC catalyzing the NOM-chloramine reaction, PAC was added to the post-ozonated sample obtained from the DLT plant. Addition of PAC to the post ozonated waters resulted in a decrease in the chloramine demand (Fig. 17). Adsorption of NOM by the PAC is the likely cause for this result. These results suggest that the activated carbon particles being generated from the BAC filters are not responsible for the high chloramine demand of the BAC filter effluent.

Membrane filtration Particles generated from the BAC filter are suspected to be responsible for the excessive chloramine demand. To find out if this was indeed the case and if so, to examine the size range of the particles being generated from the filter that were responsible for the excessive chloramine demand, BAC filter effluent samples were passed through 1.2 μ m and a 0.4 μ m polycarbonate filters (PCF) and chloraminated (Fig. 18, 19, 20, 21). In all cases, 1.2 μ m PCF filtration of the BAC filter effluent resulted in a large decrease in the chloramine demand. A further decrease in the chloramine demand was observed on filtering the sample using a 0.4 μ m filter. For the 0.4 μ m PCF filtered BAC filter effluent, most of the chloramine was consumed by autodecomposition. This

result suggests that most of the chloramine demand is caused by particles that are greater than 1.2 μm in size. To find out if the particles generated from the BAC filter were responsible for the chloramine demand, both the BAC filter influent and effluents were passed through 1.2 μm and 0.4 μm PCF (Fig. 22, 23). The chloramine demand of the 0.4 μm PCF permeate was low, regardless of whether ozonated or filtered water was processed. However, the chloramine stability was dramatically improved in the 1.2 μm permeate of the BAC filtered samples. A comparison of the chloramine demand of the 1.2 μm and 0.4 μm permeates of BAC filter influent and effluents shows that most of the chloramine demand is exerted by particles greater than 1.2 μm in size being generated from the filters. These results show that particulate matter generated from the BAC filters at the DLT plant is responsible for the increased chloramine demand.

Filter backwashing It was determined that particles being generated from the BAC filters are responsible for the increased chloramine demand of the BAC filter effluent. The number of particles that are generated from the BAC filter depends to a large extent on the filter backwashing procedure employed. To examine the role of filter backwashing procedure and filter run time on the chloramine demand, chloramine demand of the TBSWBT plant BAC filter influent and effluent samples was determined. Even though the characteristics of the influent entering the filter at the TBSWBT plant are different from that of the DLT plant, the BAC filter influents at both the plants exerted similar chloramine demands. However, BAC filtration at the TBSWT plant did not result in an increased chloramine demand. In fact, the chloramine demand of the BAC filter effluent at the TBSWBT plant was slightly lower than that of the influent (Fig. 24). Most of the

chloramine consumed by the BAC filter influent and effluent was by autodecomposition. Also, unlike the DLT plant, the chloramine demand of the BAC filter effluents at the TBSWT plant did not vary with time. These results imply that the number of particles being generated from the BAC filters at the TBSWT plant is negligible. Higher amount of time spent at the TBSWT plant for filter backwashing and the shorter filter run periods between backwashes (Table 2) could be responsible for the negligible particle generation. The filter run time at the TBSWT plant was about half that of the DLT plant. These results show that the filter backwashing mechanism and filter run period between backwashes can have a significant impact on chloramine stability of the filter effluent.

CHAPTER 6

CONCLUSIONS

Labscale ozonation of Suwannee River NOM as well as plant scale ozonation of natural water at the DLT plant resulted in a change in the chloramine demand. A change in the number of reactive sites on the NOM as a result of ozonation is thought to be responsible for the change in the chloramine demand. In labscale ozonation, the increase or decrease in the number of reactive sites following ozonation was found to be dependent on both the Ozone/TOC ratio as well as the initial pH at which ozonation was carried out. At the plant scale, the effect of ozonation on the chloramine demand may depend on nature and amount of NOM which might vary seasonally, residual metal concentration in the pre-ozonated sample. Further research is required to determine the effect these factors have on the chloramine demand of the ozonated samples. Research will also be needed to determine the role of pH on the reactions of ozone and NOM. This will help better understand the effect of ozonation on chloramine demand.

Chloramine demand of the BAC filter effluent samples obtained at different times after backwashing was determined. It was found that, in most cases, chloramine demand greatly increased after BAC filtration. Particulate matter generated from the BAC filters was found to be the major cause of chloramine instability. The fines from the activated carbon, possible components of the particulate matter eluting from the BAC filters, were found to exert an insignificant chloramine demand both in the presence and absence of NOM, which is contrary to previous speculation in the literature about their demand for

monochloramine. Initial studies show the chloramine demand of the BAC filter effluent to be a function of the HPC count. However, the effect of different types of microorganisms and their byproducts on chloramine demand needs to be investigated to better understand the role of microorganisms in the increased chloramine demand of the BAC filter effluent. Filter backwashing procedure and filter run times were found to be of critical importance to the chloramine demand exerted by the filter effluents. Effect of varying the BAC filter backwashing procedure and filter run period on chloramine demand needs to be studied at a pilot scale followed as well as full scale.

The outcome of this study will help drinking water utilities better assess and determine the factors affecting stability of monochloramine residual under various operating conditions.

Table 1. Design criteria of the Tampa Bay Surface Treatment (TBSWT) Plant biological activated carbon (BAC) filter

Total number of filter	8
Length of filter cell	66' 0"
Width of filter cell	22' 6"
Nominal filtration rate	3.86 gpm/ft ²
Max. filtration rate	3.98 gpm/ft ²
Design water depth over media	9' 7"
Filter type	Dual media
Sand layer thickness	6"
GAC layer thickness	48"
GAC size (effective size)	8x20 (1.2 mm)
GAC manufacturer	Westates (US filters)

Table 2. Comparison of the filter backwashing process at the David L. Tippin (DLT) plant and Tampa bay surface water treatment (TBSWT) plant

	DLT plant	TBSWT plant
1 st low rate backwashing	0 min	1 min (10 KGPM)
High rate backwashing	3 min (3.70 KGPM)	11 min (3.0 KGPM)
2 nd low rate backwashing	0 min	1 min (KGPM)
Flow ramp time	0 min	0 min
Flow hold time (filter to waste)	3 min	1 min
Extended backwash time	0 min	1 min
Air scour time	0.5 min	8 min
Air and water wash time	0 min	4 min

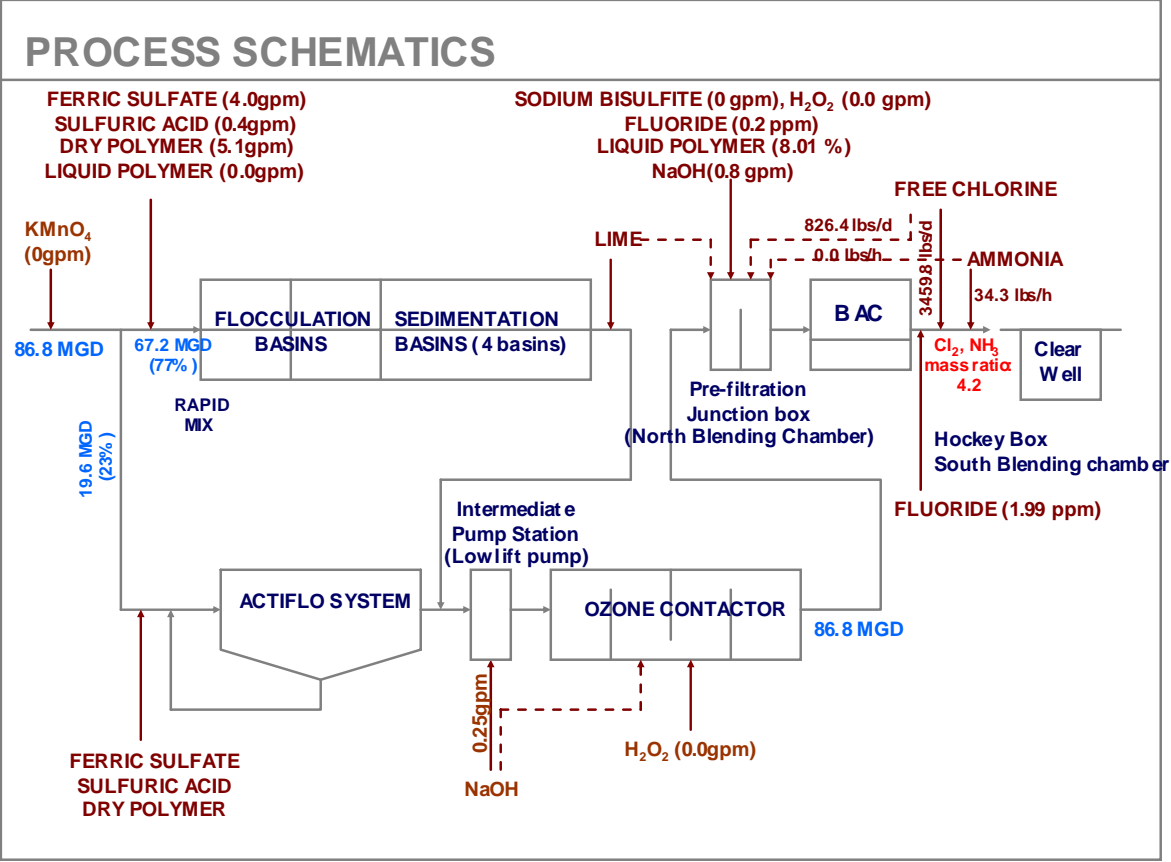

Figure 1. Process schematics of the DLT plant.

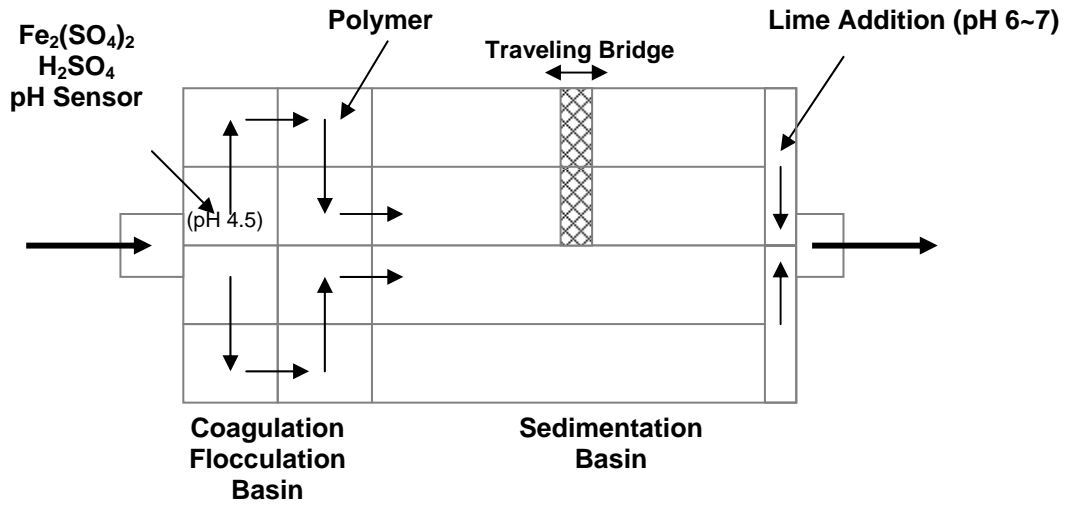

Figure 2. Coagulation and sedimentation basin schematic at the DLT plant

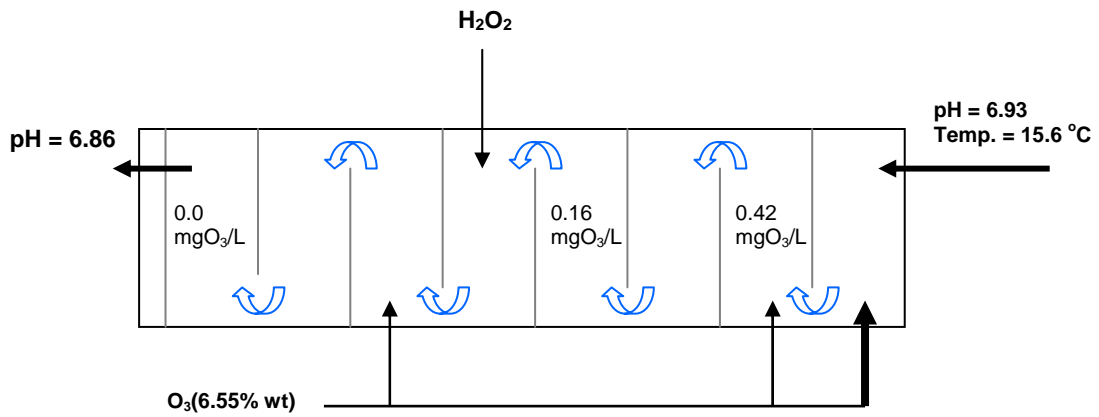

Figure 3. Schematic of the Ozone contactor at the DLT plant

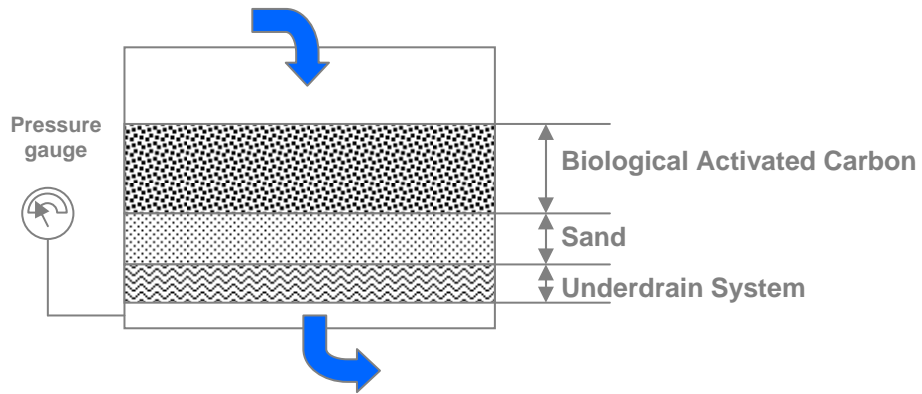

Figure 4. Cross sectional schematic of a biological activated carbon filter at the DLT plant.

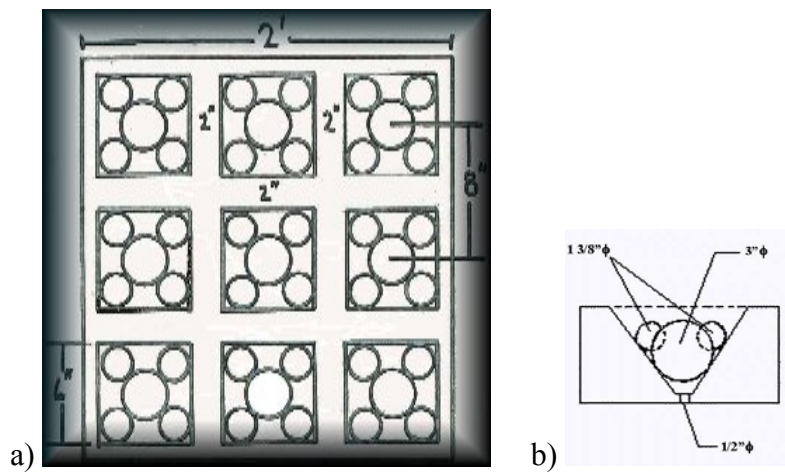

Figure 5. Wheeler type underdrain system used at the DLT Plant. a) Upper view of underdrain system, b) Side view of the underdrain system.

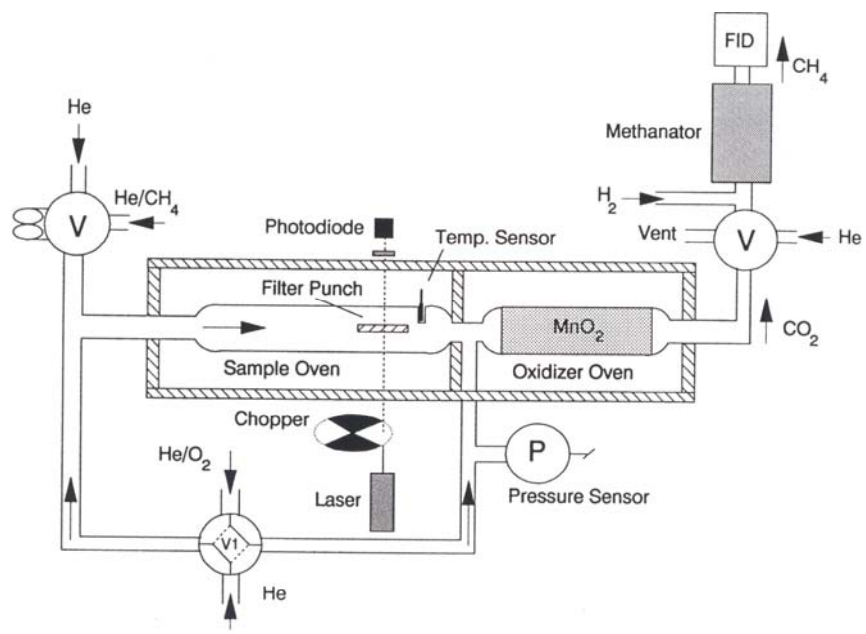

Figure 6. Process Schematic of the Thermal Optical Transmittance (TOT) instrument.

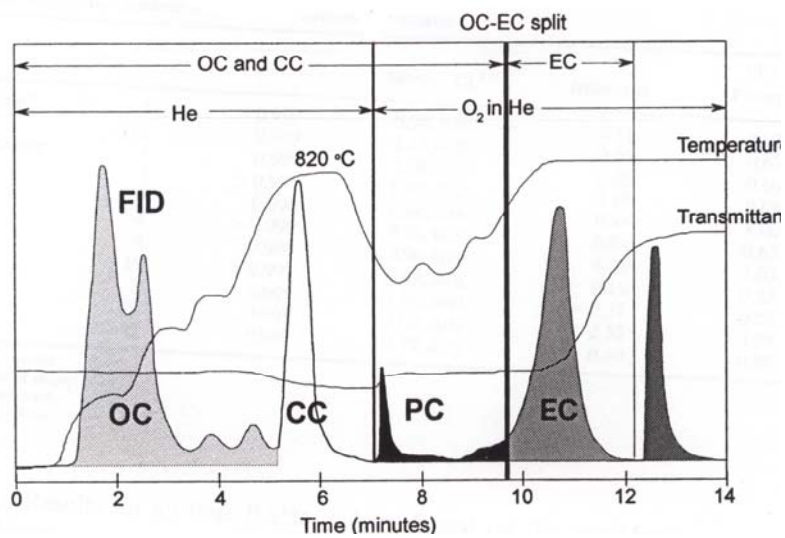

Figure 7. Sample Thermogram created by the Thermal Optical Transmitter.

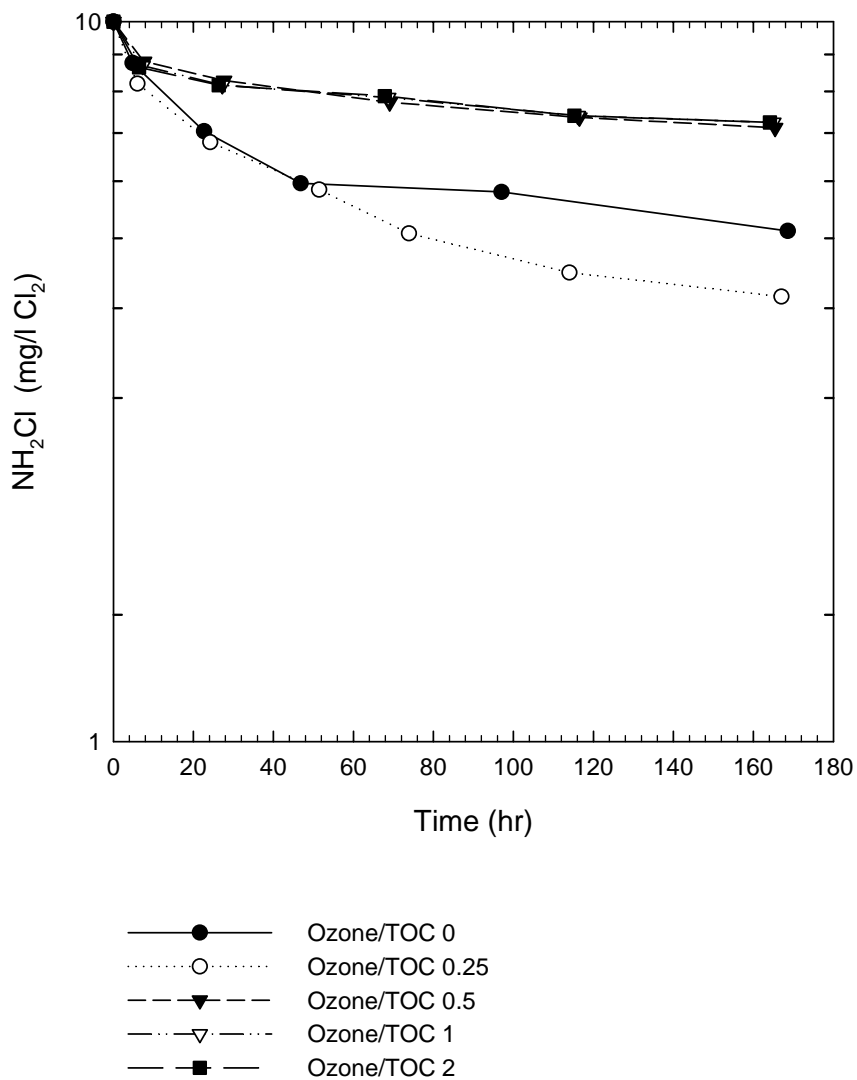

Figure 8. Effect of Lab-scale Ozonation at pH 6.5 on chloramine demand of Suwannee River natural organic matter (NOM). Ozonation carried out at varying Ozone/TOC ratios. Initial total organic carbon (TOC) concentration in all cases is 1.95mg/l. In all cases, initial $[\text{NH}_2\text{Cl}] = 10\text{mg/l as Cl}_2$, $\text{Cl/N} = 0.7$ (mol/mol), $C_{\text{T,CO}_3} = 5\text{mM}$, $\text{pH} = 6.5$, $T = 25^\circ\text{C}$.

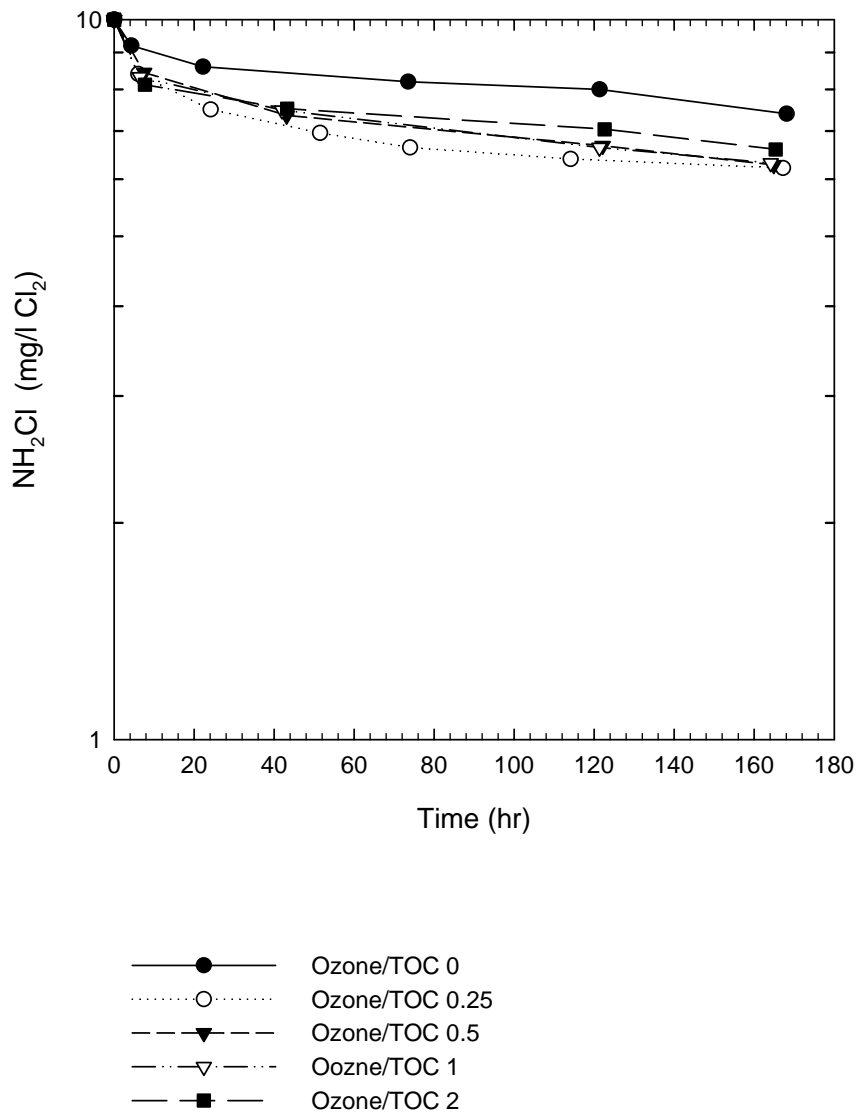

Figure 9. Effect of Labscale Ozonation at pH 7.5 on chloramine demand of Suwannee River natural organic matter (NOM). Ozonation carried out at varying Ozone/TOC ratios. Initial total organic carbon (TOC) concentration in all cases is 1.95mg/l. In all cases, initial $[\text{NH}_2\text{Cl}] = 10\text{mg/l}$ as Cl_2 , $\text{Cl/N} = 0.7$ (mol/mol), $C_{\text{T,CO}_3} = 5\text{mM}$, $\text{pH} = 7.5$, $T = 25^\circ\text{C}$.

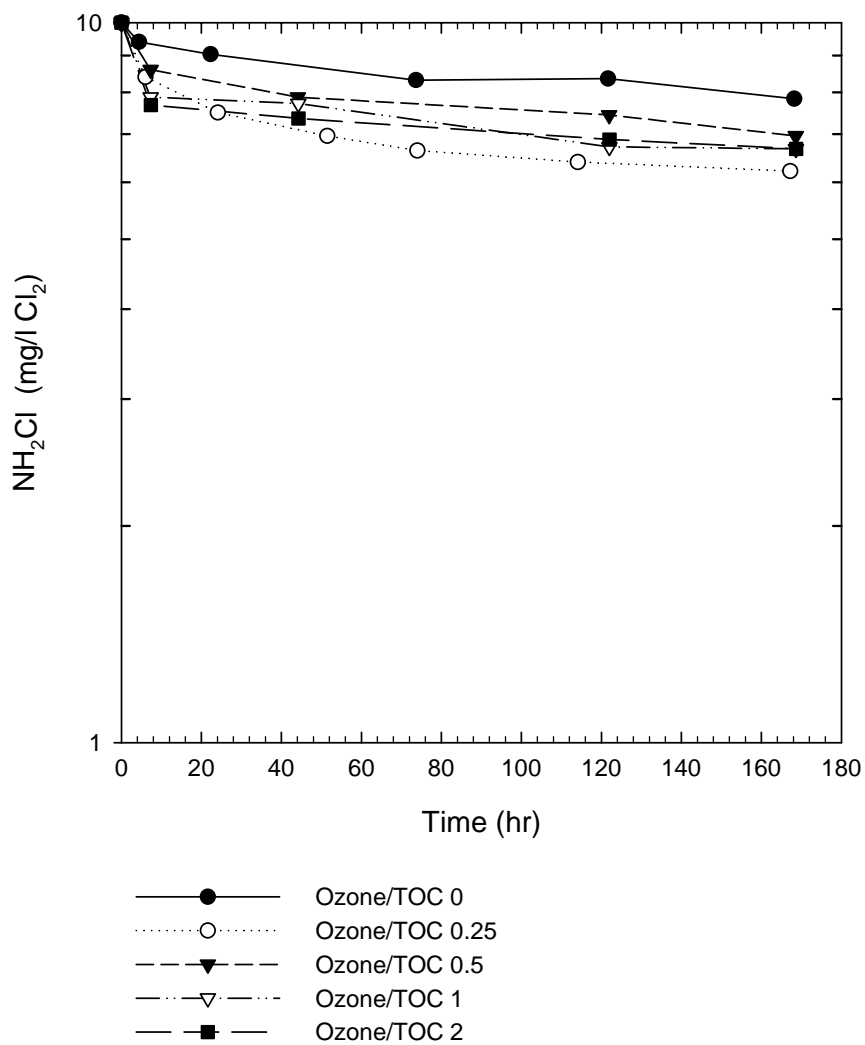

Figure 10. Effect of Labscale Ozonation at pH 8.5 on chloramine demand of Suwannee River natural organic matter (NOM). Ozonation carried out at varying Ozone/TOC ratios. Initial total organic carbon (TOC) concentration in all cases is 1.95mg/l. In all cases, initial $[\text{NH}_2\text{Cl}] = 10\text{mg/l}$ as Cl_2 , $\text{Cl/N} = 0.7$ (mol/mol), $C_{\text{T,CO}_3} = 5\text{mM}$, $\text{pH} = 8.5$, $T = 25^\circ\text{C}$.

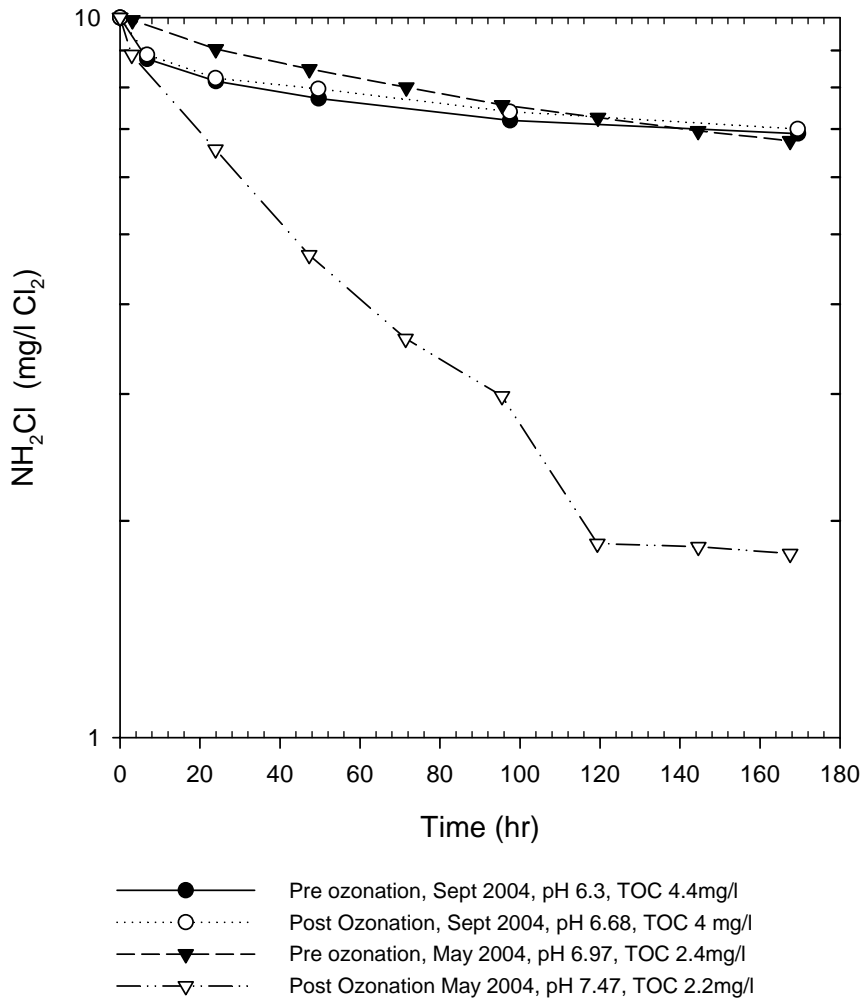

Figure 11. Effect of ozonation on the chloramine demand of the coagulated and settled waters at the DLT plant. For samples collected on May 11th, 2004, Ozone/TOC ratio ≈ 1 and for the samples collected on September 25th, 2004, Ozone/TOC ratio ≈ 0.5 . In all cases, initial $[\text{NH}_2\text{Cl}] = 10\text{mg/l}$ as Cl_2 , $\text{Cl}/\text{N} = 0.7$ (mol/mol), no buffer added, $T = 25^\circ\text{C}$.

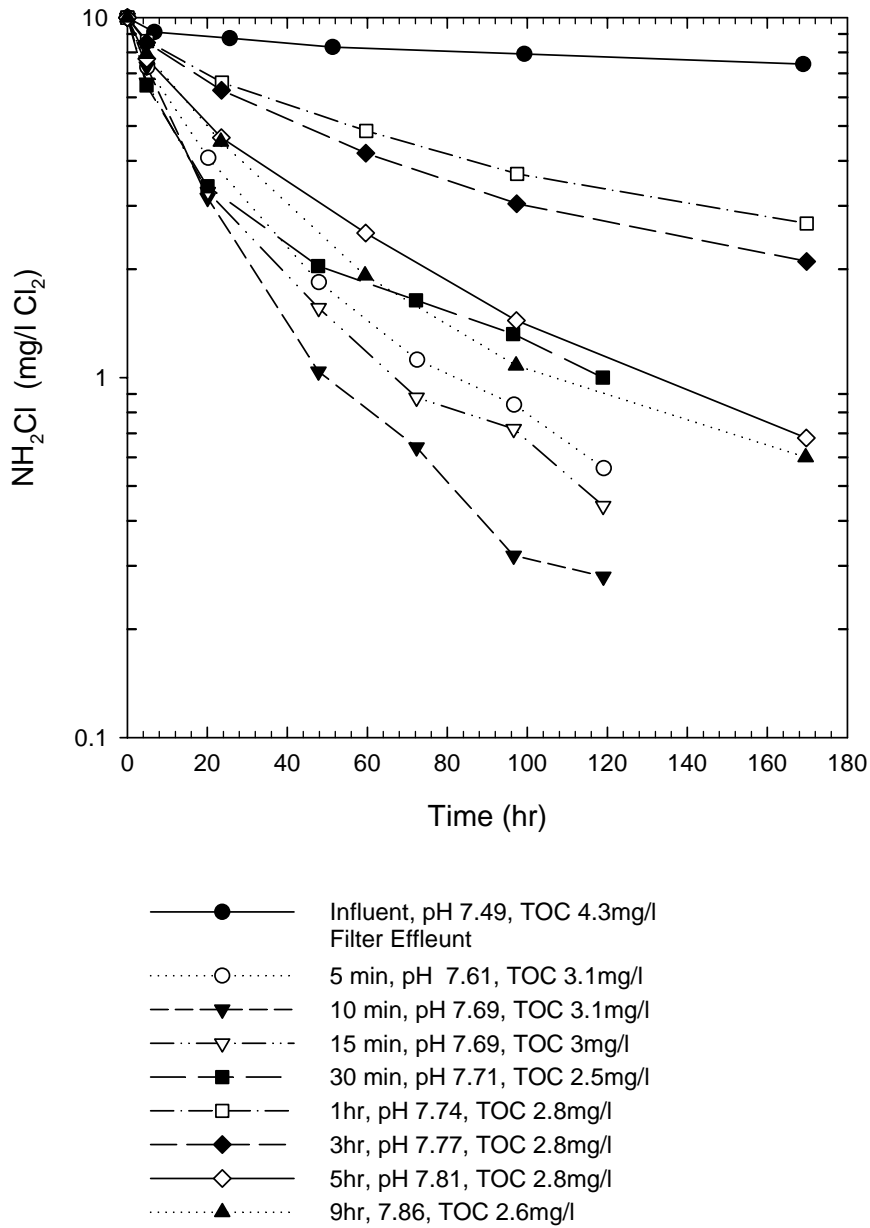

Figure 12. Chloramine demand exerted by the DLT plant BAC filter effluent samples (September 25th, 2004). In all cases, initial $[\text{NH}_2\text{Cl}] = 10\text{mg/l}$ as Cl_2 , $\text{Cl/N} = 0.7$ (mol/mol), no buffer added, $T = 25^\circ\text{C}$.

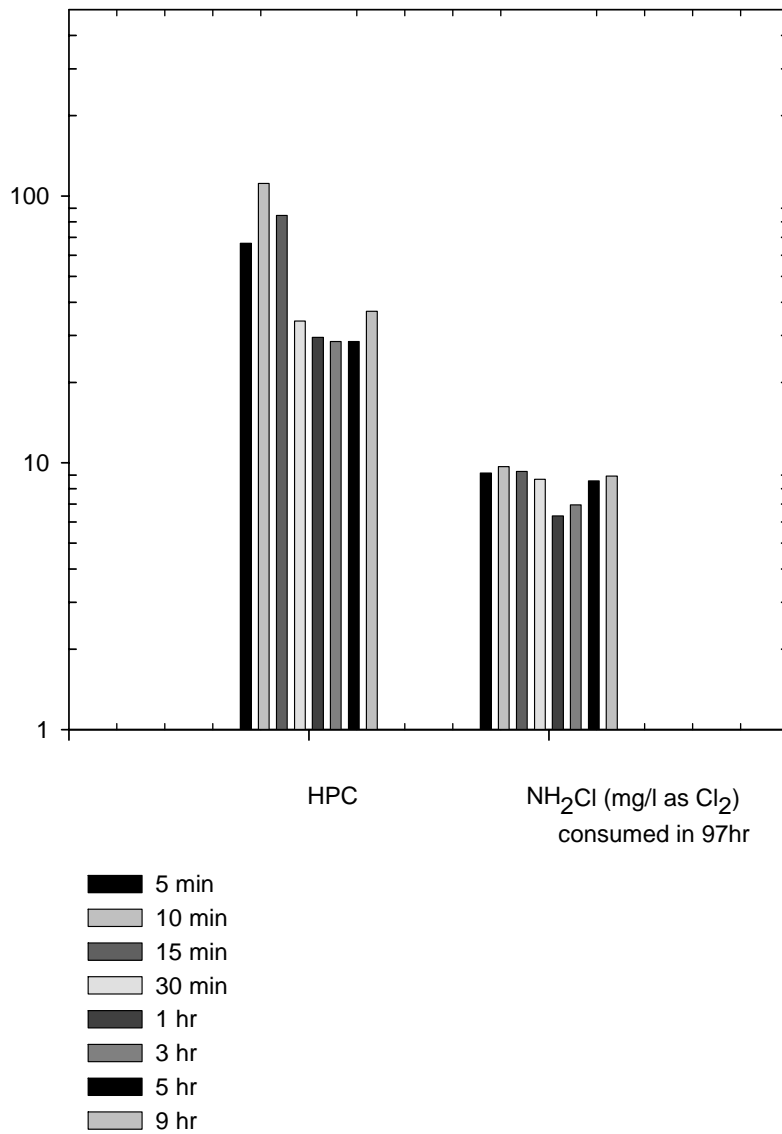

Figure 13. Effect of Heterotrophic plate count (HPC) on the amount of chloramine consumed in ≈ 97 hr by the BAC filter effluent (September 25th, 2004), obtained from the DLT plant. In all cases, initial $[\text{NH}_2\text{Cl}] = 10\text{mg/l}$ as Cl_2 , $\text{Cl/N} = 0.7$ (mol/mol), no buffer added, $T = 25^\circ\text{C}$.

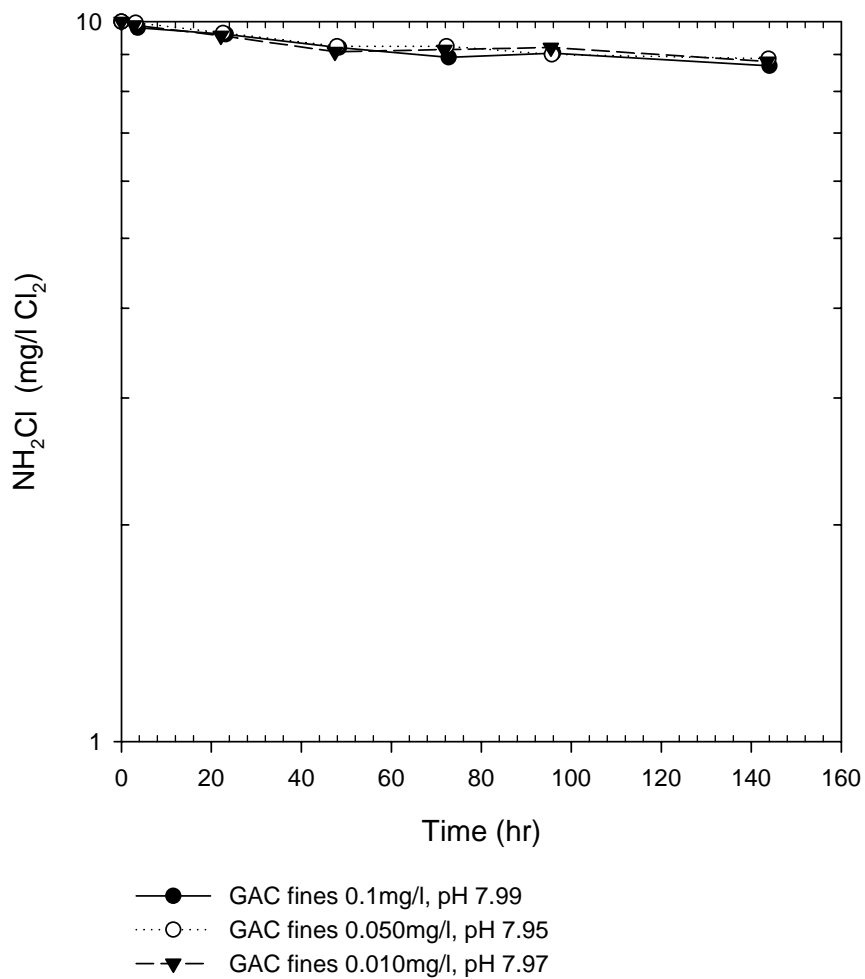

Figure 14. Chloramine demand exerted by buffered Milli-Q water containing Calgon Corp. Filtrasorb 300 granular activated carbon fines (GAC). In all cases, initial $[\text{NH}_2\text{Cl}] = 10\text{mg/l}$ as Cl_2 , $\text{Cl/N} = 0.7$ (mol/mol), $C_{\text{T,CO}_3} = 5\text{mM}$, $T = 25^\circ\text{C}$.

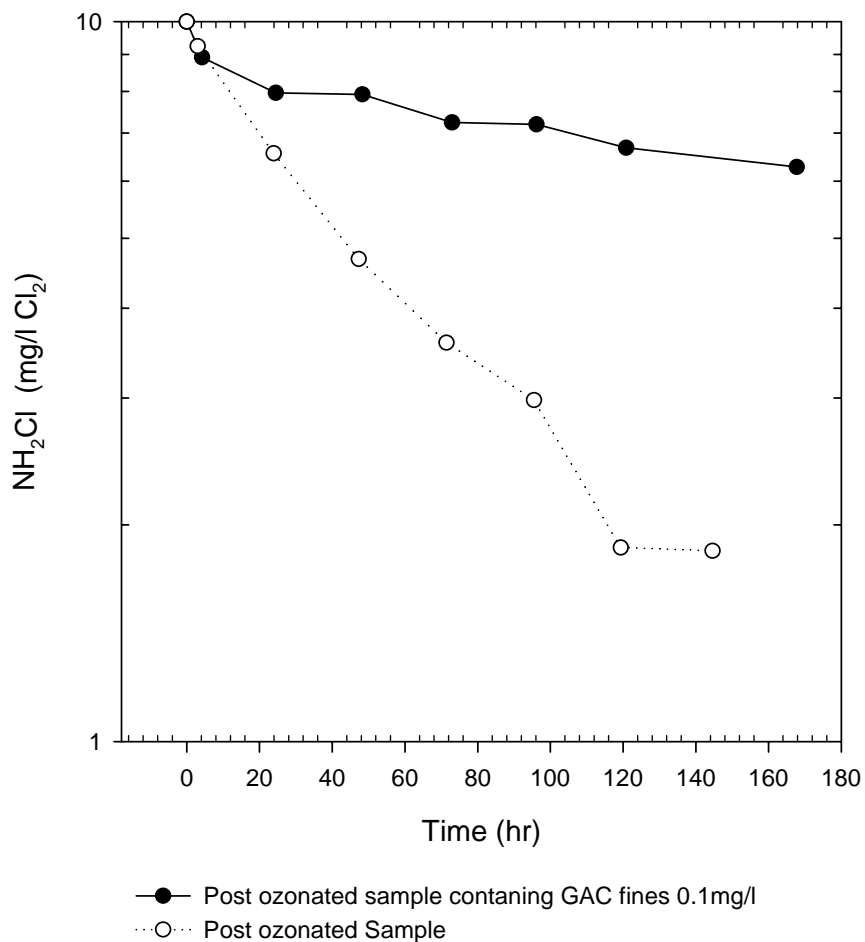

Figure 15. Chloramine demand exerted by post ozonated sample (May 11th, 2004) obtained from the DLT plant, containing Calgon Corp. Filtrasorb 300 granular activated carbon (GAC) fines. In all cases, initial $[\text{NH}_2\text{Cl}] = 10\text{mg/l}$ as Cl_2 , $\text{Cl/N } 0.7$ (mol/mol), no buffer added, $\text{pH} = 7.47$, $\text{TOC} = 2.11\text{mg/l}$, $T = 25^\circ\text{C}$.

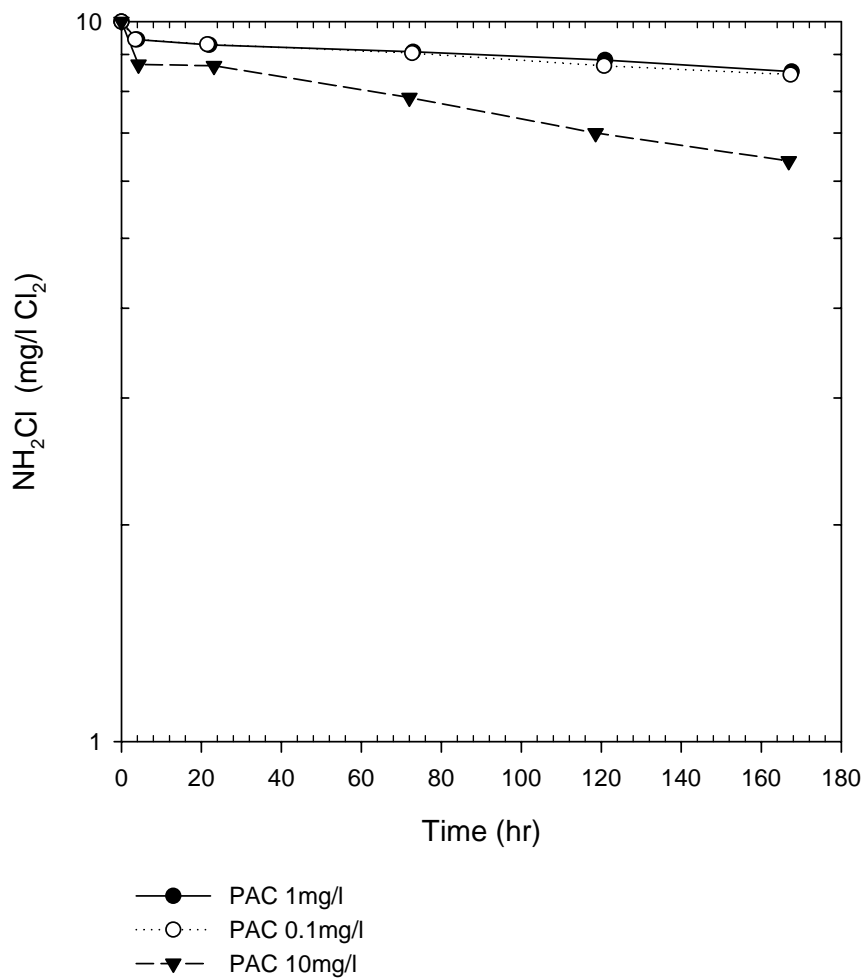

Figure 16. Chloramine demand exerted by buffered Milli-Q water containing Calgon Corp. WPL type powdered activated carbon (PAC). In all cases, initial $[\text{NH}_2\text{Cl}] = 10\text{mg/l}$ as Cl_2 , $\text{Cl/N} = 0.7$ (mol/mol), $C_{\text{T,CO}_3} = 5\text{mM}$, $\text{pH} = 8$, $T = 25^\circ\text{C}$.

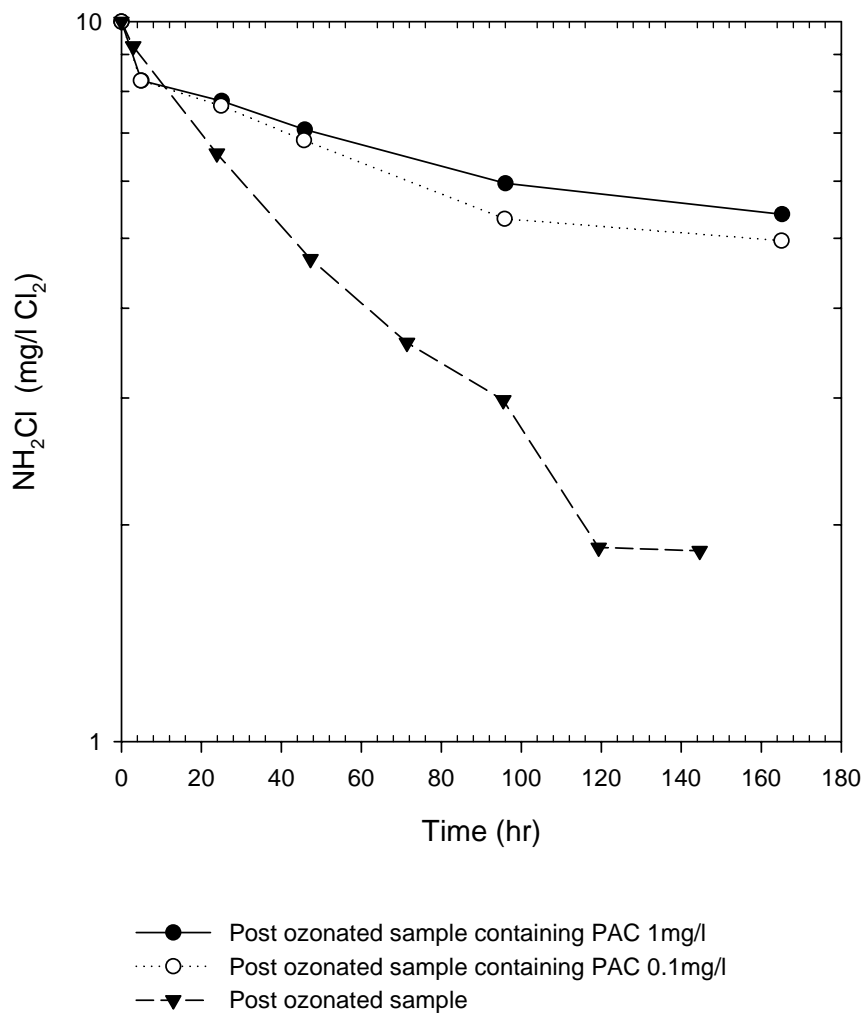

Figure 17. Chloramine demand exerted by post ozonated sample (May 11th, 2004) obtained from the DLT plant, containing Calgon Corp. WPL type powdered activated carbon (PAC). In all cases, initial $[NH_2Cl] = 10\text{mg/l}$ as Cl_2 , Cl/N 0.7 (mol/mol), no buffer added, $pH = 7.47$, $TOC = 2.11\text{mg/l}$, $T = 25^\circ\text{C}$.

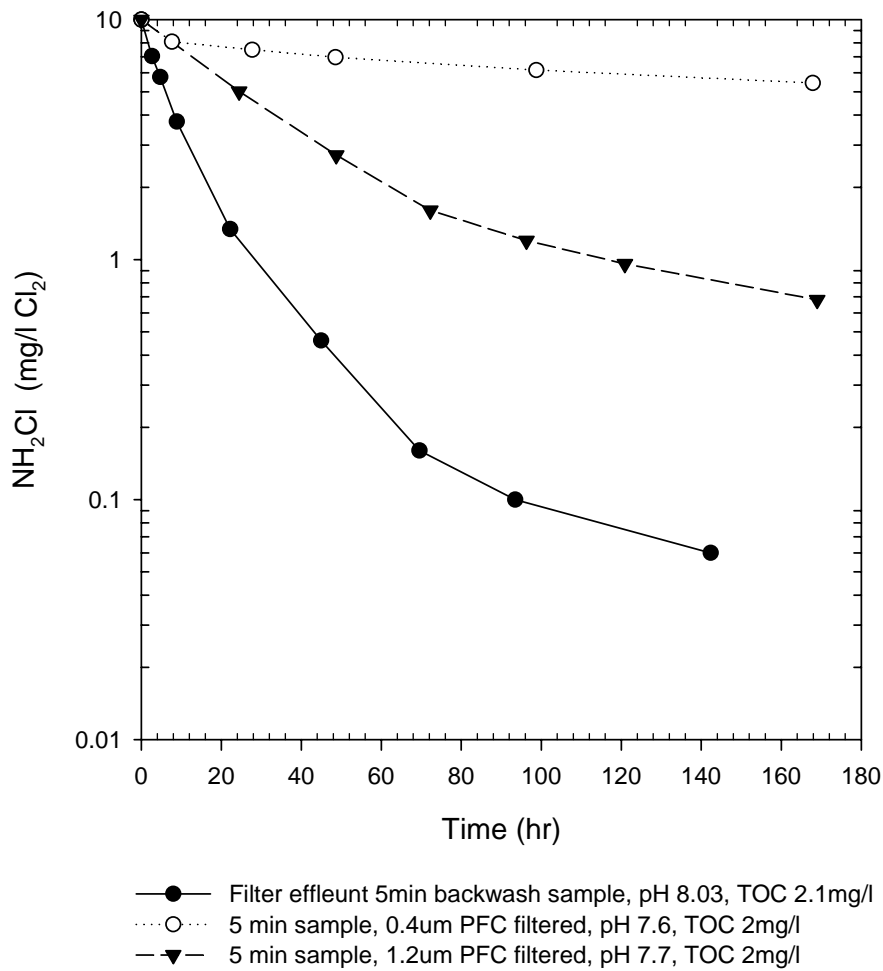

Figure 18. Comparison of the chloramine demand of the DLT plant BAC filter effluent (May 11th, 2004) obtained 5 min after backwashing with the chloramine demand of the same sample further filtered using a 0.4 μ m and 1.2 μ m polycarbonate membrane filter (PCF). In all cases, initial $[\text{NH}_2\text{Cl}] = 10\text{mg/l}$ as Cl_2 , Cl/N 0.7 (mol/mol), no buffer added, $T = 25^\circ\text{C}$.

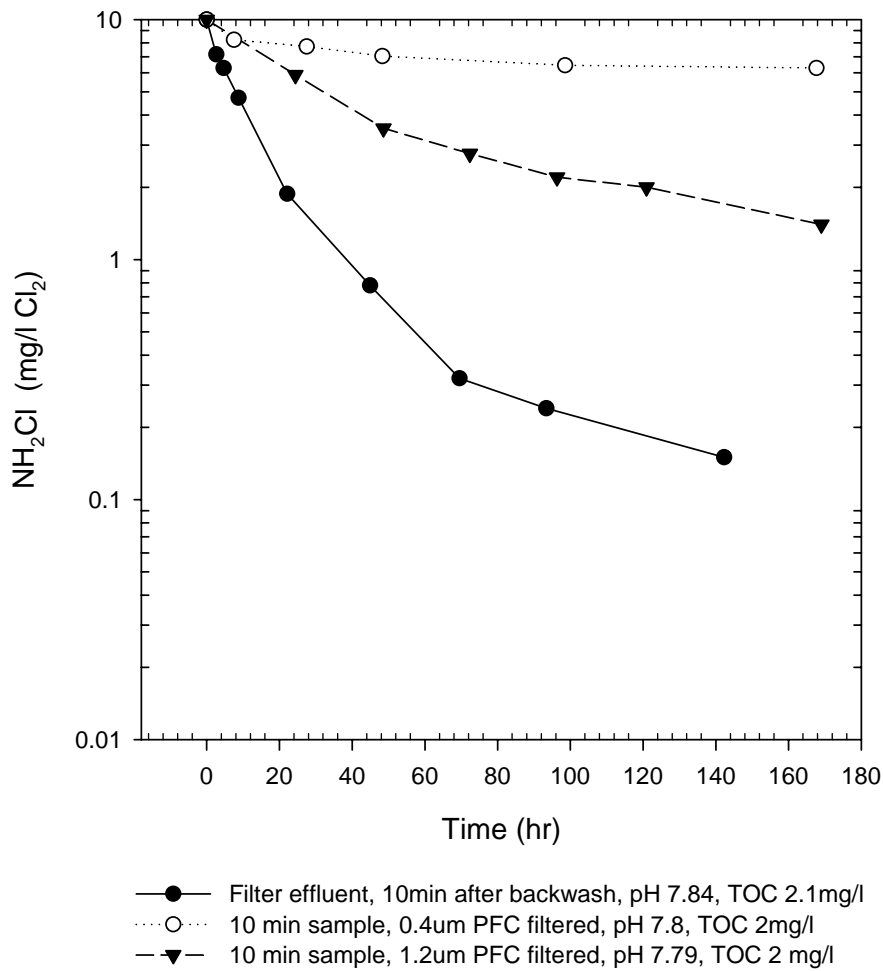

Figure 19. Comparison of the chloramine demand of the DLT plant BAC filter effluent (May 11th, 2004) obtained 10 min after backwashing with the chloramine demand of the same sample further filtered using a 0.4µm and 1.2µm polycarbonate membrane filter. In all cases, initial $[\text{NH}_2\text{Cl}] = 10\text{mg/l}$ as Cl_2 , $\text{Cl}/\text{N} 0.7$ (mol/mol), no buffer added, $T = 25^\circ\text{C}$.

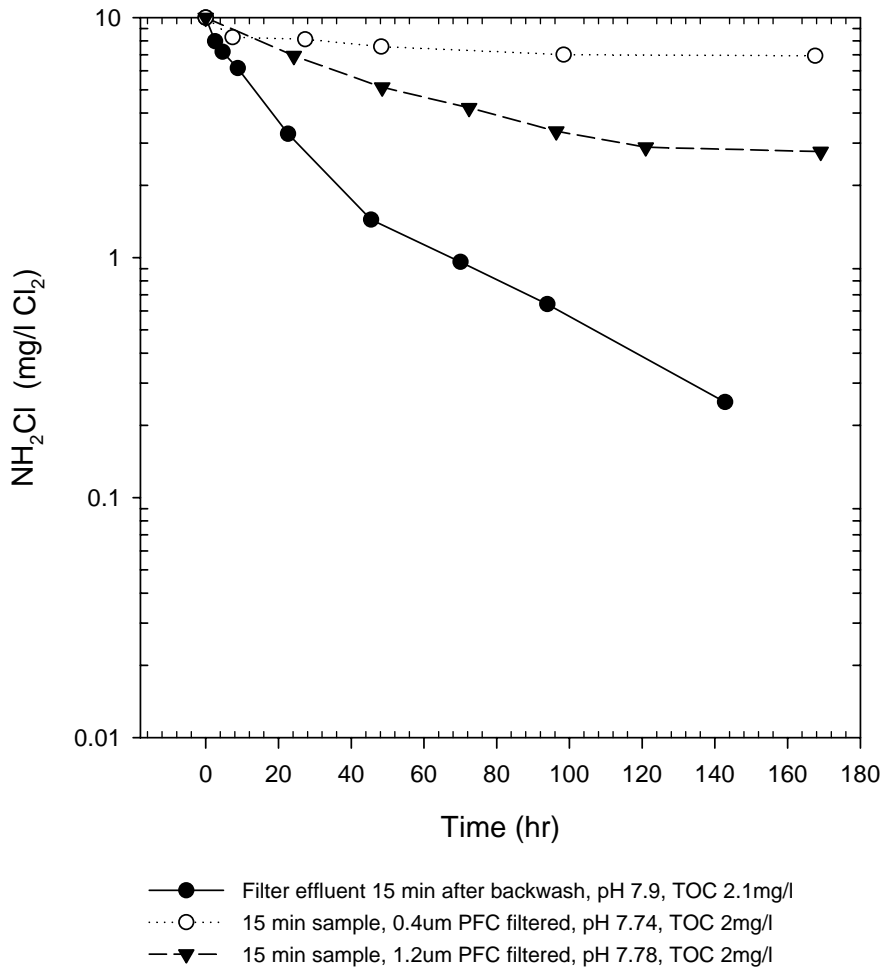

Figure 20. Comparison of the chloramine demand of the DLT plant BAC filter effluent (May 11th, 2004) obtained 15 min after backwashing with the chloramine demand of the same sample further filtered using a 0.4 μ m and 1.2 μ m polycarbonate membrane filter. In all cases, initial $[\text{NH}_2\text{Cl}] = 10\text{mg/l}$ as Cl_2 , $\text{Cl/N} = 0.7$ (mol/mol), no buffer added, $T = 25^\circ\text{C}$.

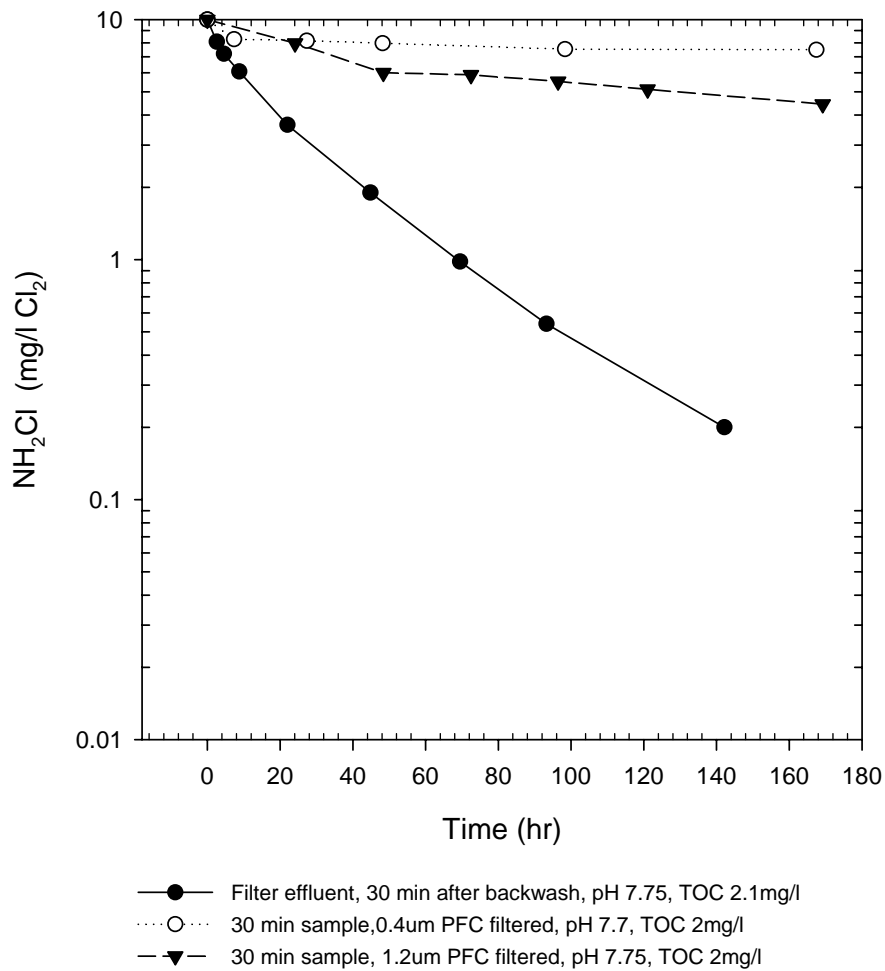

Figure 21. Comparison of the chloramine demand of the DLT plant BAC filter effluent (May 11th, 2004) obtained 30 min after backwashing with the chloramine demand of the same sample further filtered using a 0.4µm and 1.2µm polycarbonate membrane filter. In all cases, initial $[\text{NH}_2\text{Cl}] = 10\text{mg/l}$ as Cl_2 , Cl/N 0.7 (mol/mol), no buffer added, $T = 25^\circ\text{C}$.

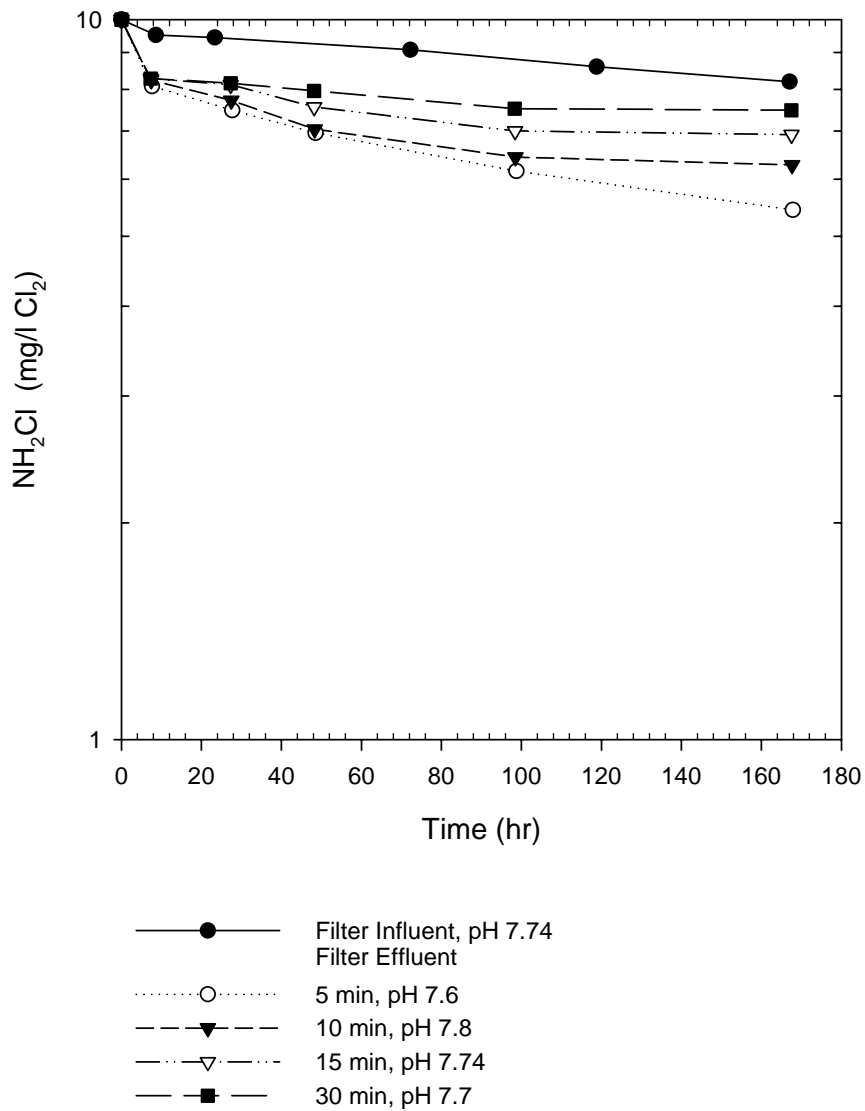

Figure 22. Comparison of the chloramine demand of the 0.4 μ m polycarbonate membrane filtered DLT Plant BAC filter influent (May 11th, 2004) and effluent. In all cases, initial $[\text{NH}_2\text{Cl}] = 10\text{mg/l}$ as Cl_2 , Cl/N 0.7 (mol/mol), no buffer added, $T = 25^\circ\text{C}$.

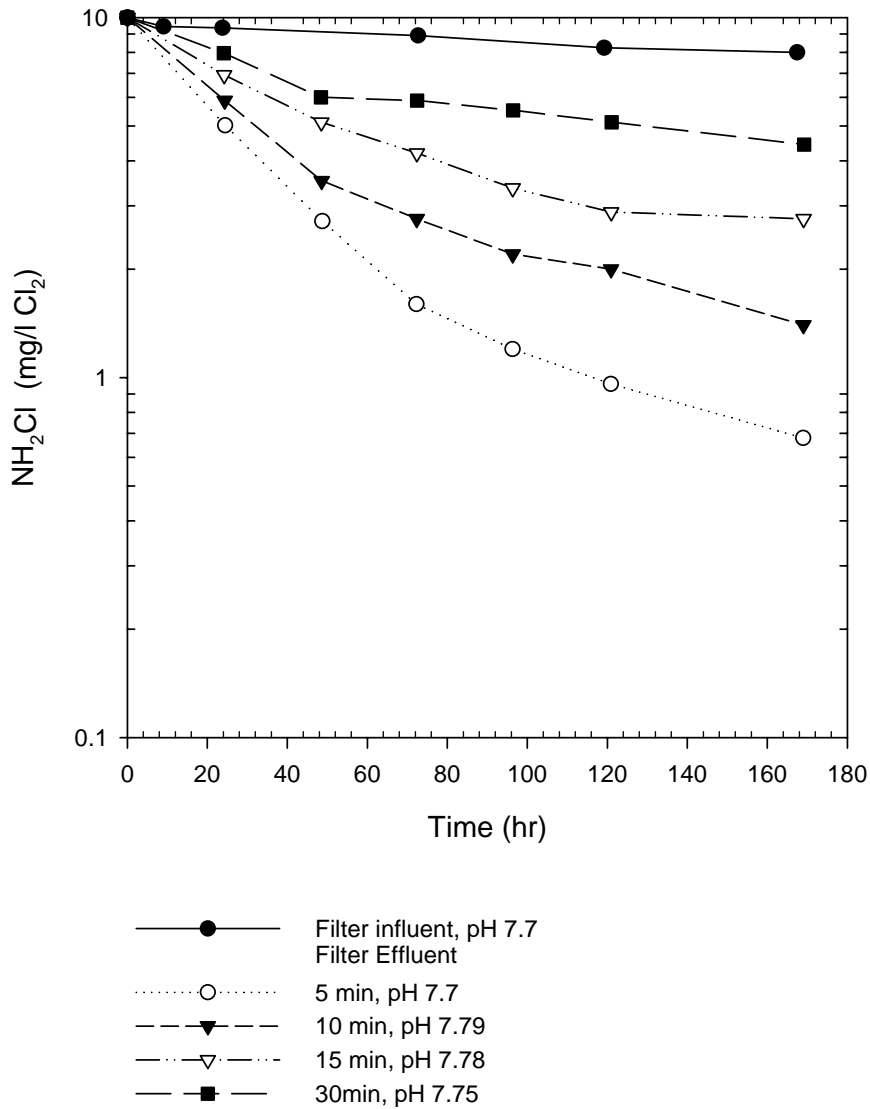

Figure 23. Comparison of the chloramine demand of the 1.2 μm polycarbonate membrane filtered DLT Plant BAC filter influent (May 11th, 2004) and effluent. In all cases, initial $[\text{NH}_2\text{Cl}] = 10\text{mg/l}$ as Cl_2 , Cl/N 0.7 (mol/mol), no buffer added, $T = 25^\circ\text{C}$.

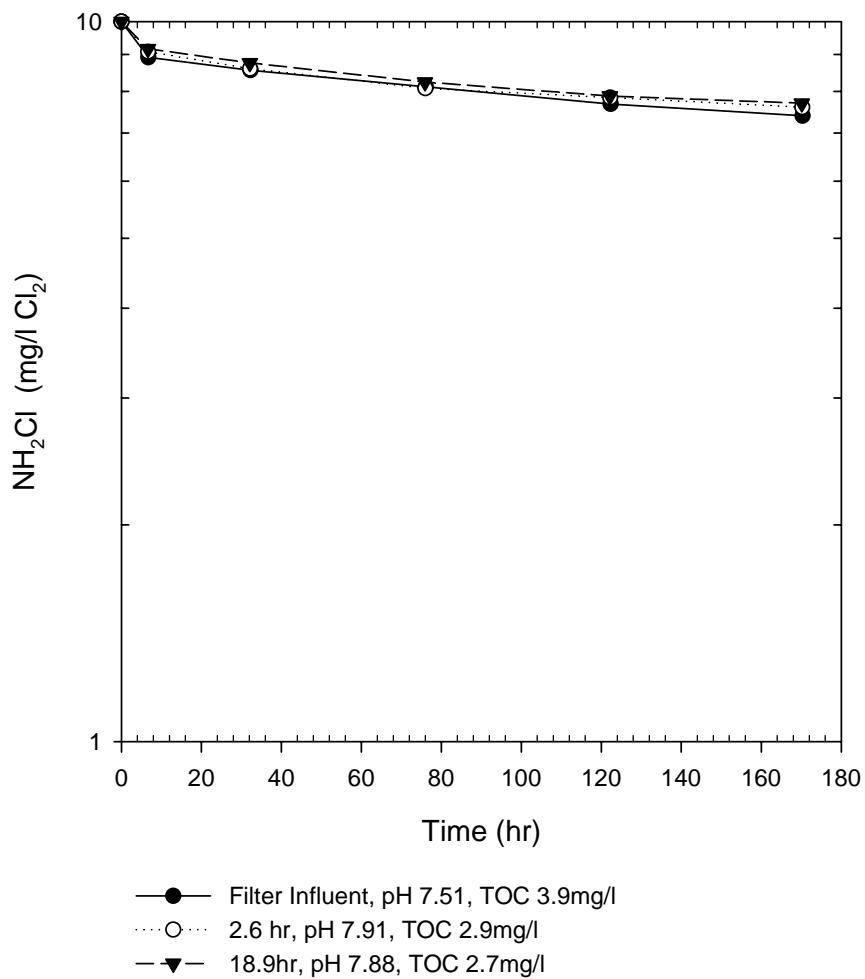

Figure 24. Chloramine demand exerted by BAC filter influent and effluent samples (September 28th, 2004), Tampa Bay Surface Water Treatment (TBSWT) Plant, collected after filter backwashing. Initial $[\text{NH}_2\text{Cl}] = 10\text{mg/l as Cl}_2$, $\text{Cl/N} = 0.7$ (mol/mol), no buffer added, $T = 25^\circ\text{C}$.

REFERENCES

- Amburgey, J., A. Amirtharajah, et al. (2003). "An enhanced backwashing technique for improved filter ripening." *Journal American Water Works Association* 95(12): 81-94.
- Amirtharajah, A. (1988). "Some Theoretical And Conceptual Views Of Filtration." *Journal American Water Works Association* 80(12): 36-46.
- Amy, G., M. Collins, et al. (1987). "The Effects of Humic Substances on Particle Formation, Growth, and Removal during Coagulation Using Aluminum Sulfate." *Abstracts of Papers of the American Chemical Society* 193: 163-ENVR.
- Amy, G., Kuo, C. (1988). "Ozonation of Humic Substances - Effects on Molecular-Weight Distributions of Organic-Carbon and Trihalomethane Formation Potential." *Ozone Science & Engineering* 10(1): 39-54.
- Bauer, R., Snoeyink, V. (1973). "Reactions of Chloramines with Activated Carbon." *Journal Water Pollution Control Federation* 45(11): 2290-2301.
- Bone, C.C., 1999. Ammonia Release form Chloramine Decay: Implications for Prevention of Nitrification Episodes. 1999 AWWA Ann. Conf. Chicago
- Camper, A., Broadaway, S. (1987). "Operational Variables and the Release of Colonized Antigranulocytes Activated Carbon Particles in Drinking Water" *Journal American Water Works Association* 79(5): 70-74.
- Edwards, M., Benjamin, M. (1992). "Transformation of NOM by Ozone and its effect on Iron and Aluminum Solubility." *Journal American Water Works Association* 84(6): 56-66.
- Edwards, M., Benjamin, M. (1994). "Effects of Ozonation on Coagulation of NOM using Polymer alone and Polymer-Metal Salt Mixtures." *Journal American Water Works Association* 86(1): 105-116.
- Hoigne, J. (1997). "Inter-calibration of OH radical sources and water quality parameters." *Water Science and Technology* 35(4): 1-8.
- Hoigne, J., Bader, H. (1978). "Ozone Initiated Oxidations of Solutes in Wastewater – Reaction Kinetic Approach." *Progress in Water Technology* 10(6): 657-671.

Hoigne, J., Bader, H. (1983). "Rate Constants of Reactions of Ozone with Organic and Inorganic-Compounds in Water.1. Non-Dissociating Organic Compounds." *Water Research* 17(2): 173-183.

Hoigne, J., Bader, H. (1983). "Rate Constants of Reactions of Ozone with Organic and Inorganic-Compounds in Water.2. Dissociating Organic Compounds." *Water Research* 17(2): 185-194.

Jacangelo, J. (1984). "The Reactivity of Monochloramine with Nucleic-Acids and Proteins." *Journal American Water Works Association* 76(4): 64-64.

Jafvert C., Valentine, R. (1992). "Reaction Scheme for the Chlorination of Ammoniacal Water." *Environmental Science and Technology* 26(3): 577-586.

Isaac, R., Morris, J. (1983). "Transfer of Active Chlorine from Chloramine to Nitrogenous Organic Compounds. 1. Kinetics". *Environmental Science and Technology* 17(12): 738-742.

Komorita, J.D., Snoeyink, V.L., 1985. Technical Note: Monochloramine Removal from Water by Activated Carbon. *Journal American Water Works Association*, 77:1:62.

Margerum, D.W., Schurter, L.M., Hobson, J., and Moore, E.E., 1994. "Water Chlorination Chemistry: Non Metal Redox Kinetics of Chloramine and Nitrite Ion." *Environmental Science and Technology*, 28(2):331-337

McCreary, J. and Snoeyink (1980). "Characterization and Activated Carbon Adsorption of Several Humic Substances" *Water Research* 14(2): 151-160.

Perdue, M., 2004. Professor, Department of Earth and Atmospheric Sciences, Georgia Institute of Technology, Personal communication.

Scaramelli, A., DiGiano, F. (1977). "Effect of Sorbed Organics on Efficiency of Ammonia Removal by Chloramine-Carbon Reactions." *Journal Water Pollution Control Federation* 49(4): 693-705.

Singer, P. (1994). "Control of Disinfection By-Products in Drinking Water." *Journal of Environmental Engineering-ASCE* 120(4): 727-744.

Stahelin, J., Hoigne, J. (1985) "Decomposition of Ozone in Water in the Presence of Organic Solutes Acting as Promoters and Inhibitors of radical Chain Reactions." *Environmental Science & Technology* 19(12): 1206-1213.

Standard Methods for the Examination of Water and Wastewater, 1998 (20th ed.). APHA, AWWA, AND WEF, WASHINGTON.

Stringfellow, W., Mallon, K. et al. (1993). "Enumerating and Disinfecting Bacteria Associated with Particles Released from GAC Filter-Adsorbers." *Journal American Water Works Association* 85(9): 70-80.

Tokuno, S. (1997). "Granular activated carbon filtration and nitrification." *Water-Engineering and Management* 144(2): 22-25.

Tokuno, S. (1999). "Granular activated carbon filtration and chloramine." *Water-Engineering and Management* 146(1): 16-21.

Valentine, R., C. Jafvert, et al. (1988). "Evaluation of a Chloramine Decomposition Valuation of a Chloramine Decomposition Model Incorporating General Acid Catalysis." *Water Research* 22(9): 1147-1153.

Vikesland, P., K. Ozekin, et al. (1998). "Effect of natural organic matter on monochloramine decomposition: Pathway elucidation through the use of mass and redox balances." *Environmental Science & Technology* 32(10): 1409-1416.

Vikesland, P. and R. Valentine (2000). "Reaction pathways involved in the reduction of monochloramine by ferrous iron." *Environmental Science & Technology* 34(1): 83-90.

Vikesland, P. and R. Valentine (2002). "Iron oxide surface-catalyzed oxidation of ferrous iron by monochloramine: Implications of oxide type and carbonate on reactivity." *Environmental Science & Technology* 36(3): 512-519.

Vikesland, P. and R. Valentine (2002). "Modeling the kinetics of ferrous iron oxidation by monochloramine." *Environmental Science & Technology* 36(4): 662-668.

Valentine, R., Jafvert, C. et al. (1988). "Evaluation of a Chloramine Decomposition Model Incorporating General Acid Catalysis" *Water Research* 22(9): 1147-1153.

Vikesland, P., K. Ozekin, et al. (1998). "Effect of natural organic matter on monochloramine decomposition: Pathway elucidation through the use of mass and redox balances." *Environmental Science & Technology* 32(10): 1409-1416.

Vikesland, P. and R. Valentine (2000). "Reaction pathways involved in the reduction of monochloramine by ferrous iron." *Environmental Science & Technology* 34(1): 83-90.

Vikesland, P. and R. Valentine (2002). "Iron oxide surface-catalyzed oxidation of ferrous iron by monochloramine: Implications of oxide type and carbonate on reactivity." *Environmental Science & Technology* 36(3): 512-519.

Vikesland, P. and R. Valentine (2002). "Modeling the kinetics of ferrous iron oxidation by monochloramine." *Environmental Science & Technology* 36(4): 662-668.

Westerhoff, P., G. Aiken, et al. (1999). "Relationships between the structure of natural organic matter and its reactivity towards molecular ozone and hydroxyl radicals." *Water Research* 33(10): 2265-2276.

Wilczak, A., L. Hoover, et al. (2003). "Effects of treatment changer on chloramine demand and decay." *Journal American Water Works Association* 95(7): 94-106.

Wolfe, R., Ward, N. et al. (1984). "Inorganic Chloramines as Drinking Water Disinfectants – A review" *Journal American Water Works Association* 76(5): 74-88.

Wolfe, R., N. Ward, et al. (1985). "Inactivation of Heterotrophic Bacterial-Populations in Finished Drinking-Water by Chlorine and Chloramines" *Water Research* 19(11): 1393-1403.

Yavich, A. and S. Masten (2001). "Modeling the kinetics of the reaction of ozone with natural organic matter in Huron River water." *Ozone-Science & Engineering* 23(2): 105-119.